

2W isolated DC-DC converter
Fixed input voltage, unregulated single or dual output

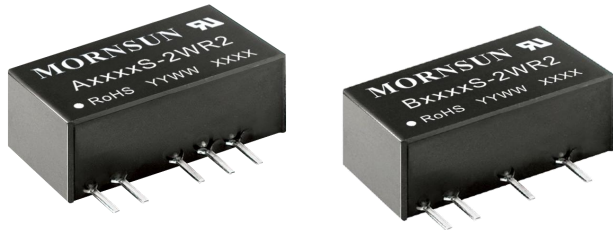

FEATURES

- High power density
- High efficiency up to 86%
- Operating ambient temperature range: -40°C to +105°C
- No external components required
- Miniature SIP package
- Industry standard pin-out
- I/O isolation test voltage 1.5k VDC
- IEC60950/UL60950/EN60950 Approved



A_S-2WR2 & B_S-2WR2 series is designed for use in distributed power supply systems and especially suitable in applications such as pure digital circuits, low frequency analog circuits, relay-driven circuits and data switching circuits, where:

1. The voltage of the input power supply is relatively stable with a variation of $\pm 10\%V_{in}$ or less;
2. An input to output isolation voltage of up to 1500VDC is necessary;
3. The requirement for a tight output regulation is not as strict.

Selection Guide

Certification	Part No.	Input Voltage (VDC)	Output		Full Load Efficiency (%) Min./Typ.	Capacitive Load*(μ F) Max.
		Nominal (Range)	Voltage (VDC)	Current (mA) Max./Min.		
UL/CE/CB	A0503S-2WR2	5 (4.5-5.5)	± 3.3	$\pm 303/\pm 30$	67/71	100
	A0505S-2WR2		± 5	$\pm 200/\pm 20$	76/80	
	A0509S-2WR2		± 9	$\pm 111/\pm 11$	80/84	
	A0512S-2WR2		± 12	$\pm 83/\pm 8$	80/84	
	A0515S-2WR2		± 15	$\pm 67/\pm 7$	78/82	
	A0524S-2WR2		± 24	$\pm 42/\pm 4$	80/84	
UL/CE/CB	B0503S-2WR2	5 (4.5-5.5)	3.3	400/40	75/79	220
	B0505S-2WR2		5	400/40	80/84	
	B0509S-2WR2		9	222/22	75/79	
	B0512S-2WR2		12	167/17	80/84	
	B0515S-2WR2		15	133/13	80/84	
	B0524S-2WR2		24	83/8	80/84	
-	B0905S-2WR2	9 (8.1-9.9)	5	400/40	75/79	220
	B0912S-2WR2		12	167/17	79/83	
UL/CE/CB	A1205S-2WR2	12 (10.8-13.2)	± 5	$\pm 200/\pm 20$	76/80	100
	A1209S-2WR2		± 9	$\pm 111/\pm 11$	78/82	
	A1212S-2WR2		± 12	$\pm 83/\pm 8$	80/84	
	A1215S-2WR2		± 15	$\pm 67/\pm 7$	80/84	
	A1224S-2WR2		± 24	$\pm 42/\pm 4$	80/84	
UL/CE/CB	B1203S-2WR2	12 (10.8-13.2)	3.3	400/40	75/79	220
	B1205S-2WR2		5	400/40	78/82	
	B1209S-2WR2		9	222/22	77/81	
	B1212S-2WR2		12	167/17	80/84	
	B1215S-2WR2		15	133/13	81/85	
	B1224S-2WR2		24	83/8	82/86	
-	A1505S-2WR2	15 (13.5-16.5)	± 5	$\pm 200/\pm 20$	74/78	100
	A1515S-2WR2		± 15	$\pm 67/\pm 7$	77/81	

--	B1505S-2WR2	15 (13.5-16.5)	5	400/40	74/78	220
	B1515S-2WR2		15	133/13	78/82	
	B1524S-2WR2		24	83/8	78/82	
UL/CE/CB	A2403S-2WR2	24 (21.6-26.4)	±3.3	±303/±30	76/80	100
	A2405S-2WR2		±5	±200/±20	76/80	
	A2409S-2WR2		±9	±111/±11	82/86	
	A2412S-2WR2		±12	±83/±8	80/84	
	A2415S-2WR2		±15	±67/±7	80/84	
	A2424S-2WR2		±24	±42/±4	80/84	
--	B2403S-2WR2	24 (21.6-26.4)	3.3	400/40	75/79	220
UL/CE/CB	B2405S-2WR2		5	400/40	76/80	
	B2409S-2WR2		9	222/22	82/86	
	B2412S-2WR2		12	167/17	80/84	
	B2415S-2WR2		15	133/13	82/86	
	B2424S-2WR2		24	83/8	82/86	

Note: * The specified maximum capacitive load for positive and negative output is identical.

Input Specifications

Item	Operating Conditions	Min.	Typ.	Max.	Unit
Input Current (full load / no-load)	5V input	--	506/35	--/60	mA
	9V input	--	268/25	--/50	
	12V input	--	208/20	--/50	
	15V input	--	167/15	--/35	
	24V input	--	104/10	--/30	
Reflected Ripple Current		--	15	--	mA
Surge Voltage (1sec. max.)	5V input	-0.7	--	9	VDC
	9V input	-0.7	--	12	
	12V input	-0.7	--	18	
	15V input	-0.7	--	21	
	24V input	-0.7	--	30	
Input Filter		Capacitance filter			
Hot Plug		Unavailable			

Output Specifications

Item	Operating Conditions	Min.	Typ.	Max.	Unit	
Voltage Accuracy		See output regulation curve(Fig. 1)				
Linear Regulation	Input voltage change: ±1%	3.3VDC output	--	--	±1.5	--
		Other output	--	--	±1.2	
Load Regulation	10%-100% load	3.3VDC output	--	18	--	%
		5VDC output	--	12	--	
		9VDC output	--	9	--	
		12VDC output	--	8	--	
		15VDC output	--	7	--	
		24VDC output	--	6	--	
Ripple & Noise*	20MHz bandwidth	--	75	200	mVp-p	
Temperature Coefficient	Full load	--	--	±0.03	%/°C	

Short-circuit Protection**	A24xxS-2WR2/B24xxS-2WR2 A12xxS-2WR2/B12xxS-2WR2 A15xxS-2WR2/B15xxS-2WR2 A0524S-2WR2/B0524S-2WR2	--	--	1	s
	Others	Continuous, self-recovery			

Notes: * The "parallel cable" method is used for ripple and noise test, please refer to DC-DC Converter Application Notes for specific information.

** At the end of the short circuit duration, the supply voltage must be disconnected from following models:

A24xxS-2WR2/B24xxS-2WR2/A12xxS-2WR2/B12xxS-2WR2/A15xxS-2WR2/B15xxS-2WR2 series, and A0524S-2WR2/B0524S-2WR2.

General Specifications

Item	Operating Conditions	Min.	Typ.	Max.	Unit
Isolation Voltage	Input-output Electric strength test for 1 minute with a leakage current of 1mA max.	1500	--	--	VDC
Insulation Resistance	Input-output resistance at 500VDC	1000	--	--	MΩ
Isolation Capacitance	Input-output capacitance at 100kHz/0.1V	--	20	--	pF
Operating Temperature	Derating when operating temperature up to 85°C, (see Fig. 2)	-40	--	105	°C
Storage Temperature		-55	--	125	
Case Temperature Rise	Ta=25°C, nominal input, full load output	--	25	--	
Pin Soldering Resistance Temperature	Soldering spot is 1.5mm away from case for 10 seconds	--	--	300	
Storage Humidity	Non-condensing	--	--	95	%RH
Switching Frequency	Full load, nominal input voltage	--	100	--	kHz
MTBF	MIL-HDBK-217F @ 25°C	3500	--	--	k hours

Mechanical Specifications

Case Material	Black plastic; flame-retardant and heat-resistant (UL94 V-0)
Dimensions	19.65 x 7.05 x 10.16mm
Weight	2.4g (Typ.)
Cooling Method	Free air convection

Electromagnetic Compatibility (EMC)

Emission	CE	CISPR32/EN55032	CLASS B (see Fig. 4 for recommended circuit)
	RE	CISPR32/EN55032	CLASS B (see Fig. 4 for recommended circuit)
Immunity	ESD	A_S-2WR2	IEC/EN61000-4-2 Contact ±6kV performance Criteria B
		B_S-2WR2	IEC/EN61000-4-2 Contact ±8kV performance Criteria B

Typical Performance Curves

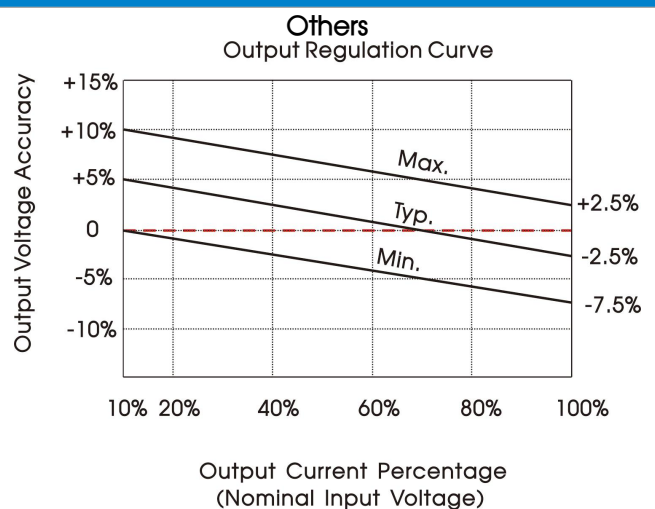
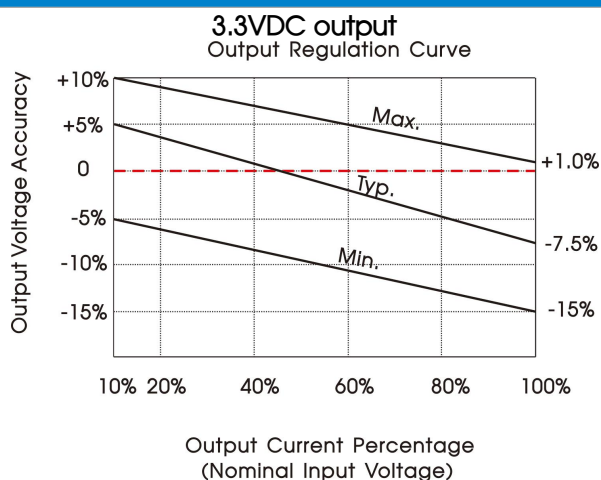
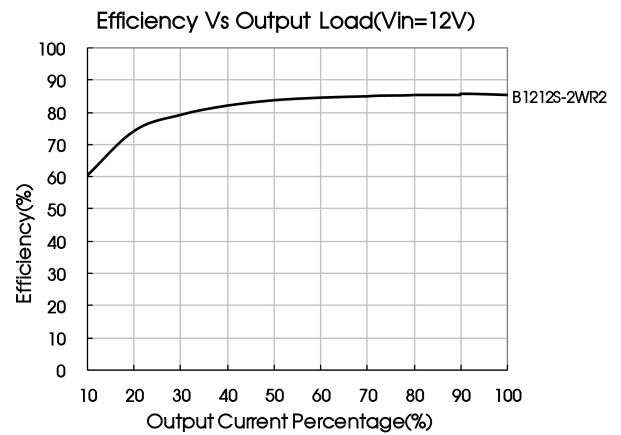
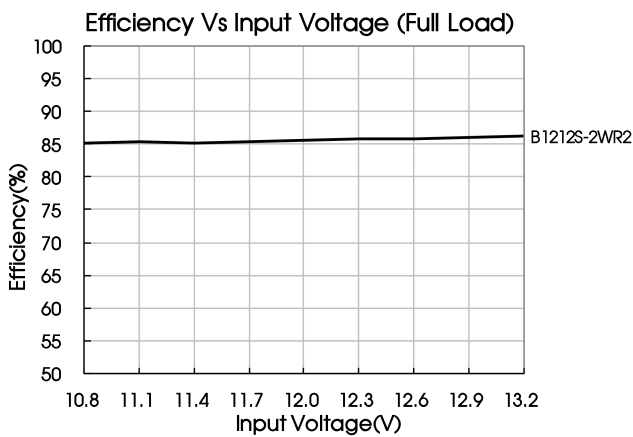
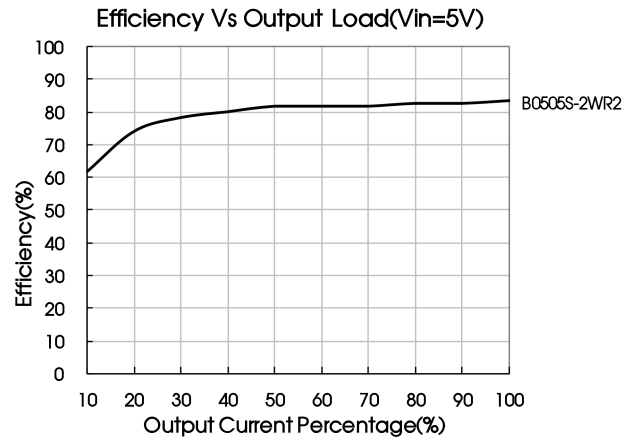
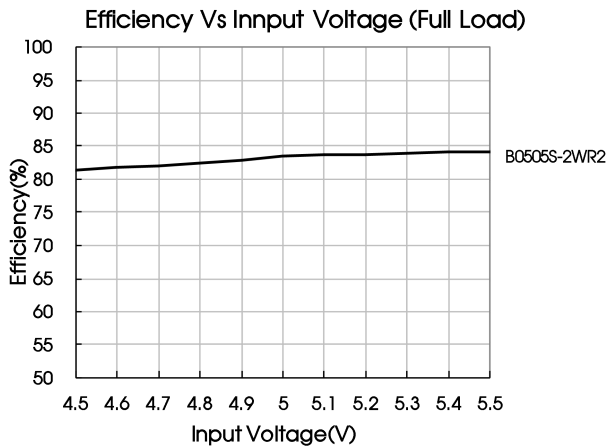
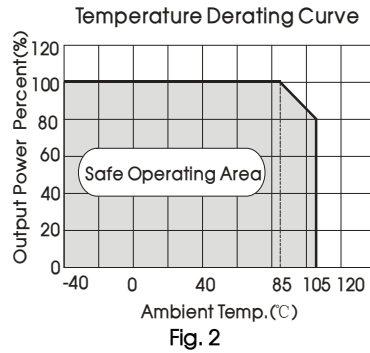

Fig. 1



Design Reference

1. Typical application

Input and/or output ripple can be further reduced, by connecting a filter capacitor from the input and/or output terminals to ground as shown in Fig.3.

Choosing suitable filter capacitor values is very important for a smooth operation of the modules, particularly to avoid start-up problems caused by capacitor values that are too high. For recommended input and output capacitor values refer to Table 1.

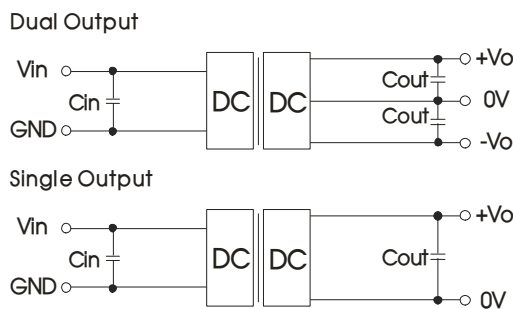

Table 1: Recommended input and output capacitor values

Vin (VDC)	Cin (μF)	Single Vo (VDC)	Cout (μF)	Dual Vo (VDC)	Cout (μF)
5	4.7	3.3/5	10	±3.3/±5	4.7
9/12	2.2	9/12	2.2	±9/±12	1
15	2.2	15/24	1	±15/±24	0.47
24	1	--	--	--	--

2. EMC (CLASS B) compliance circuit

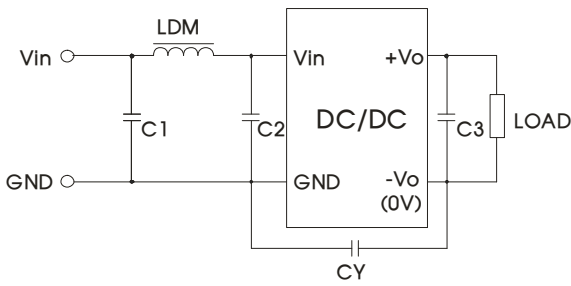

Fig. 4

Input voltage (VDC)		5/9/12/15	24
EMI	C1/C2	4.7μF /50V	
	CY	--	1nF/2kV
	C3	Refer to Cout in Fig.3	
	LDM	6.8μH	

Note: For 24V input models use a Y-capacitor CY of 1nF/2kV.

3. Minimum Output Load Requirement

For a reliable and efficient operation of the converter, the minimum load should never be less than 10% of the rated output load. If the total required output power is below 10%, a parallel bleeding resistor is required on the output, ensuring that the sum of the power consumption is always maintained at 10% minimum.

4. For additional information, please refer to DC-DC converter application notes on www.mornsun-power.com

Dimensions and Recommended Layout

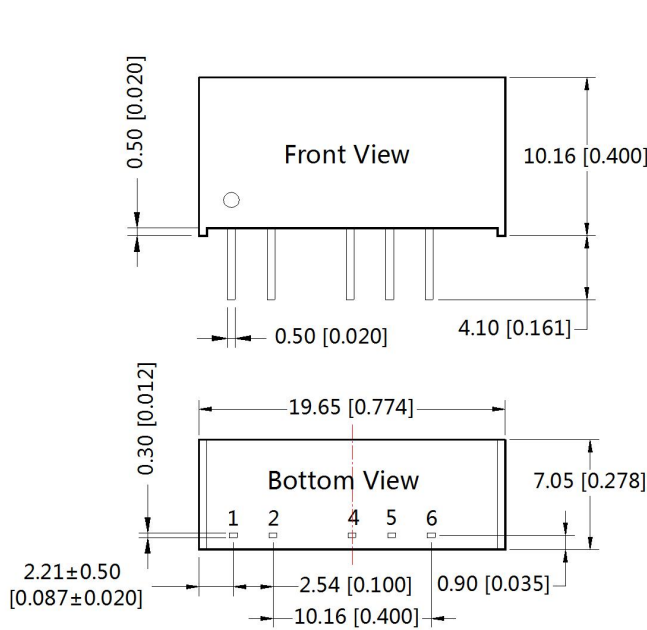

Note:
Unit :mm[inch]
Pin section tolerances :±0.10[±0.004]
General tolerances:±0.25[±0.010]

THIRD ANGLE PROJECTION

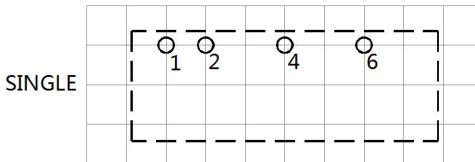
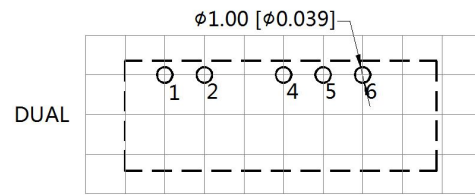

Note : Grid 2.54*2.54mm

Pin-Out		
Pin	Single	Dual
1	Vin	Vin
2	GND	GND
4	0V	-Vo
5	No Pin	0V
6	+Vo	+Vo

Notes:

1. Packing information please refer to Product Packing Information which can be downloaded from www.mornsun-power.com. Packing bag number: 58200001;
2. If the product is not operated within the required load range, the product performance cannot be guaranteed to comply with all parameters in the datasheet;
3. The maximum capacitive load offered were tested at input voltage range and full load;
4. Unless otherwise specified, parameters in this datasheet were measured under the conditions of $T_a=25^{\circ}\text{C}$, humidity<75%RH with nominal input voltage and rated output load;
5. All index testing methods in this datasheet are based on our Company corporate standards;
6. We can provide product customization service, please contact our technicians directly for specific information;
7. Products are related to laws and regulations: see "Features" and "EMC";
8. Our products shall be classified according to ISO14001 and related environmental laws and regulations, and shall be handled by qualified units.

MORNSUN Guangzhou Science & Technology Co., Ltd.

Address: No. 5, Kehui St. 1, Kehui Development Center, Science Ave., Guangzhou Science City, Luogang District, Guangzhou, P. R. China
Tel: 86-20-38601850-8801 Fax: 86-20-38601272 E-mail: info@mornsun.cn