



TURBO HD D3T Series Bullet & Turret Camera User Manual

User Manual

Thank you for purchasing our product. If there are any questions, or requests, do not hesitate to contact the dealer.

This manual applies to the models below:

Model	
Type I Camera	DS-2CE16D3T-I3PF DS-2CE16D3T-I3F
Type II Camera	DS-2CE16D3T-ITPF DS-2CE16D3T-ITF
Type III Camera	DS-2CE16D3T-IT3F
Type IV Camera	DS-2CE76D3T-ITMF
Type V Camera	DS-2CE78D3T-IT3F
Type VI Camera	DS-2CE57D3T-VPITF
Type VII Camera	DS-2CE76D3T-ITPF

This manual may contain several technical incorrect places or printing errors, and the content is subject to change without notice. The updates will be added to the new version of this manual. We will readily improve or update the products or procedures described in the manual.

Regulatory Information

FCC Information

Please take attention that changes or modification not expressly approved by the party responsible for compliance could void the user's authority to operate the equipment.

FCC compliance: This equipment has been tested and found to comply with the limits for a Class A digital device, pursuant to part 15 of the FCC Rules. These limits are designed to provide reasonable protection against harmful interference when the equipment is operated in a commercial environment. This equipment generates, uses, and can radiate radio frequency energy and, if not installed and used in accordance with the instruction manual, may cause harmful interference to radio communications. Operation of this equipment in a residential area is likely to cause harmful interference in which case the user will be required to correct the interference at his own expense.

FCC Conditions

This device complies with part 15 of the FCC Rules.

Operation is subject to the following two conditions:

1. This device may not cause harmful interference.
2. This device must accept any interference received, including interference that may cause undesired operation.

EU Conformity Statement



This product and - if applicable - the supplied accessories too are marked with "CE" and comply therefore with the applicable harmonized European

standards listed under the Low Voltage Directive 2014/35/EU, the EMC Directive 2014/30/EU, the RoHS Directive 2011/65/EU.



2012/19/EU (WEEE directive): Products marked with this symbol cannot be disposed of as unsorted municipal waste in the European Union. For proper recycling, return this product to your local supplier upon the purchase of equivalent new

equipment, or dispose of it at designated collection points. For more information see: www.recyclethis.info.

2006/66/EC (battery directive): This product contains a battery that cannot be disposed of as unsorted municipal waste in the European Union. See the product documentation for specific battery information. The battery is marked with this symbol, which may

include lettering to indicate cadmium (Cd), lead (Pb), or mercury (Hg). For proper recycling, return the battery to your supplier or to a designated collection point. For more information, see: www.recyclethis.info.



Industry Canada ICES-003 Compliance

This device meets the CAN ICES-3 (A)/NMB-3(A) standards requirements.

Warning

This is a class A product. In a domestic environment this product may cause radio interference in which case the user may be required to take adequate measures.



Safety Instruction

These instructions are intended to ensure that user can use the product correctly to avoid danger or property loss.

The precaution measure is divided into “Warnings” and “Cautions”.

Warnings: Serious injury or death may occur if any of the warnings are neglected.

Cautions: Injury or equipment damage may occur if any of the cautions are neglected.

	
Warnings Follow these safeguards to prevent serious injury or death.	Cautions Follow these precautions to prevent potential injury or material damage.



Warnings

- In the use of the device, you must be in strict compliance with the electrical safety regulations of the nation and region.
- Input voltage should meet both the SELV (Safety Extra Low Voltage) and the Limited Power Source with 12 VDC according to the IEC60950-1 standard. Refer to technical specifications for detailed information.
- Do not connect multiple devices to one power adapter to avoid over-heating or a fire hazard caused by overload.
- Make sure that the plug is firmly connected to the power socket.
- Make sure that the device is firmly fixed if wall mounting or ceiling mounting is adopted.
- If smoke, odor or noise rise from the device, turn off the power at once and unplug the power cord, and then contact the service center.
- Never attempt to disassemble the camera by unprofessional personal.



Cautions

- Do not drop the camera or subject it to physical shock.
- Do not touch sensor modules with fingers.
- Do not place the camera in extremely hot, cold (the operating temperature shall be -40°C to 60°C), dusty or damp locations, and do not expose it to high electromagnetic radiation.
- If cleaning is necessary, use clean cloth with a bit of ethanol and wipe it gently.
- Do not aim the camera at the sun or extra bright places.
- The sensor may be burned out by a laser beam, so when any laser equipment is in using, make sure that the surface of sensor will not be exposed to the laser beam.
- Do not expose the device to high electromagnetic radiation or extremely hot, cold, dusty or damp environment.
- To avoid heat accumulation, good ventilation is required for the operating environment.

- Keep the camera away from liquid while in use for non-water-proof device.
- While in delivery, the camera shall be packed in its original packing, or packing of the same texture.

Mark Description

Table 0-1 Mark Description

Mark	Description
---	DC Voltage

1 Introduction

1.1 Product Features

The main features are as follows:

- High performance CMOS sensor
- IR cut filter with auto switch
- OSD menu with configurable parameters
- Auto white balance
- Internal synchronization
- SMART IR mode
- 4 in 1 video output (TVI/AHD/CVI/ CVBS)
- 3-axis adjustment

1.2 Overview

1.2.1 Type I Camera

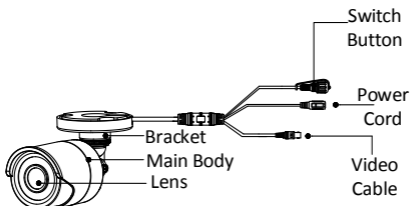

Figure 1-1 Overview of Type I Camera

Note:

Press and hold the switch button for 5 seconds to switch the video output. Four kinds of video outputs are available: TVI, AHD, CVI, and CVBS.

1.2.2 Type II Camera

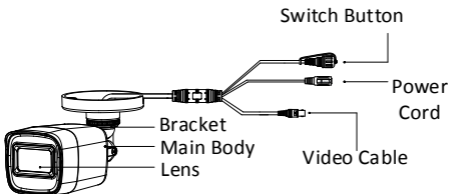

Figure 1-2 Overview of Type II Camera

Note:

Press and hold the switch button for 5 seconds to switch the video output. Four kinds of video outputs are available: TVI, AHD, CVI, and CVBS.

1.2.3 Type III Camera

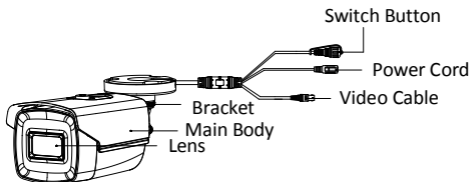

Figure 1-3 Overview of Type III Camera

Note:

Press and hold the switch button for 5 seconds to switch the video output. Four kinds of video outputs are available: TVI, AHD, CVI, and CVBS.

1.2.4 Type IV Camera

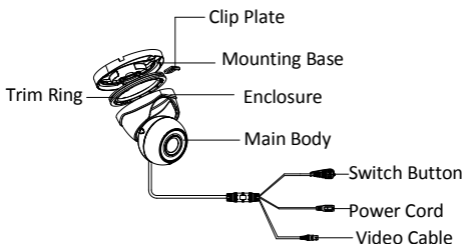

Figure 1-4 Overview of Type IV Camera

Note:

Press and hold the switch button for 5 seconds to switch the video output. Four kinds of video outputs are available: TVI, AHD, CVI, and CVBS.

1.2.5 Type V Camera

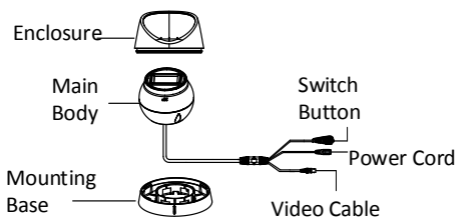

Figure 1-5 Overview of Type V Camera

Note:

Press and hold the switch button for 5 seconds to switch the video output. Four kinds of video outputs are available: TVI, AHD, CVI, and CVBS.

1.2.6 Type VI Camera

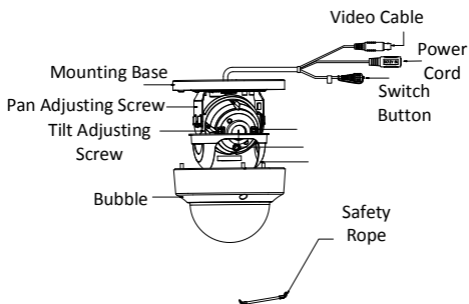

Figure 1-6 Overview of Type VI Camera

Note:

Press and hold the switch button for 5 seconds to switch the video output. Four kinds of video outputs are available: TVI, AHD, CVI, and CVBS.

1.2.7 Type VII Camera

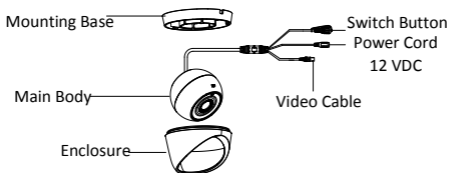

Figure 1-7 Overview of Type VII Camera

Note:

Press and hold the switch button for 5 seconds to switch the video output. Four kinds of video outputs are available: TVI, AHD, CVI, and CVBS.

2 Menu Description

Please follow the steps below to call the menu.

Note:

The menu description part is only for your reference. It might have some differences due to the specific model that you have.

Steps:

1. Connect the camera with the TVI DVR, and the monitor, shown as the Figure 2-1.

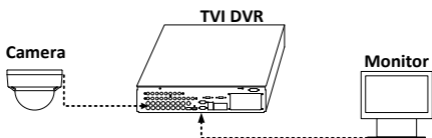



Figure 2-1 Connection

2. Power on the analog camera, TVI DVR, and the monitor to view the image on the monitor.
3. Click PTZ Control to enter the PTZ Control interface.
4. Call the camera menu by clicking  button, or call the preset No. 95.

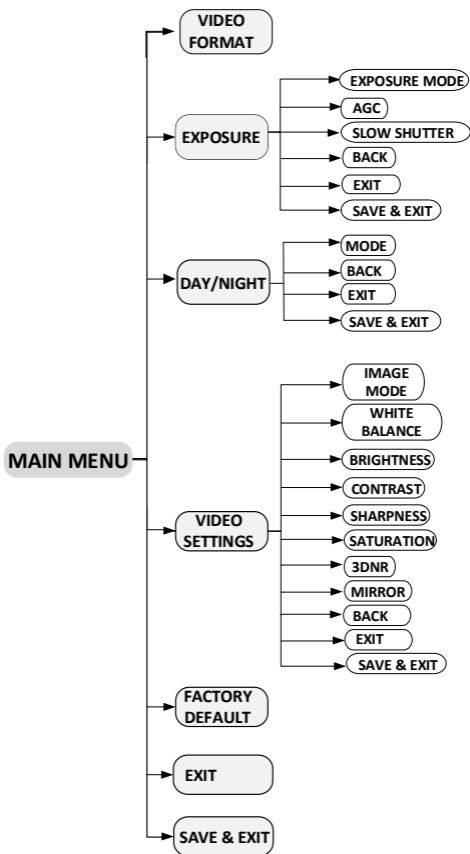

Figure 2-2 Main Menu Overview

5. Click the direction arrow to control the camera.

- 1). Click up/down direction button to select the item.
- 2). Click Iris + to confirm the selection.
- 3). Click left/right direction button to adjust the value of the selected item.

2.1 VIDEO FORMAT

You can select the video format as 2MP@25fps , or 2MP@30fps.

Note:

When switching the video output as CVBS, you can set the video format as PAL, or NTSC.

2.1 EXPOSURE

Exposure describes the brightness-related parameters, which can be adjusted by **EXPOSURE MODE**, and **AGC**.

EXPOSURE	
EXPOSURE MODE	◀ GLOBAL ▶
AGC	◀ LOW ▶
SLOW SHUTTER	◀ OFF ▶
BACK	← ↵
EXIT	← ↵
SAVE & EXIT	← ↵

Figure 2-3 EXPOSURE

EXPOSURE MODE

You can set the **EXPOSURE MODE** as **GLOBAL**, **BLC**, **HLC**, and **WDR**.

- **GLOBAL**

GLOBAL refers to the normal exposure mode which performs exposure according to the whole image brightness.

- **BLC (Backlight Compensation)**

BLC (Backlight Compensation) compensates light for the front object to make it clear, but this may cause the over-exposure of the background, where the light is strong.

- **HLC (Highlight Compensation)**

HLC stands for highlight compensation. The camera detects the strong spots (the over-exposure portion of image), then reduce the brightness of the strong spots to improve the overall images. This function is designed to allow camera to capture vehicle plate license at night.

- **WDR (Wide Dynamic Range)**

The **WDR** helps the camera provide clear images even under backlight circumstances. When both very bright and very dark areas simultaneously exist in the image, **WDR** balances the brightness level of the whole image to provide clear images with details.

AGC (Automatic Gain Control)

It optimizes the clarity of the image in poor light conditions. The **AGC** level can be set as **HIGH**, **MEDIUM**, or **LOW**.

Note:

The noise will be amplified when setting the **AGC** level. The higher the level is, the more obvious the noise is.

SLOW SHUTTER

SLOW SHUTTER increases the exposure time on a single frame, which makes the camera more sensitive to the light so that it can produce images even in low lux conditions.

You can set the **SLOW SHUTTER** function as OFF, x2, x4, x6, x8, x10, x12, x14, or x16 according to the different light conditions.

2.2 DAY/NIGHT

COLOR, **B&W** (Black White), and **AUTO** are selectable for DAY and NIGHT switches.

COLOR

The image is colored in day mode all the time.

B/W

The image is black and white all the time, and it is better to turn the IR LIGHT on in poor light conditions.

- **IR LIGHT**

You can turn on/off the IR LIGHT to meet the requirements of different circumstances.

- **SMART IR**

The **Smart IR** function is used to adjust the light to its most suitable intensity, and prevent the image from over exposure.

You can select the mode as **MODE 1**, or **MODE 2**.

MODE 1 is the default mode that can be applied to both indoor conditions, and outdoor conditions. When selecting the **MODE 1**, the IR Light has more obvious effects.

- **LEVEL**

The **LEVEL** value can be adjusted from 0 to 3. The greater the value is, the more obvious effects are.

AUTO

You can turn on/off the **IR LIGHT**, and set the mode of **SMART IR** in this menu.

DAY/NIGHT	
MODE	◀ AUTO ▶
IR LIGHT	◀ ON ▶
SMART IR	◀ MODE1 ▶
LEVEL	◀ 2 ▶
D → N THRESHOLD	◀ 7 ▶
N → D THRESHOLD	◀ 7 ▶
BACK	←
EXIT	←
SAVE & EXIT	←

Figure 2-4 DAY NIGHT

- **IR LIGHT**

You can turn on/off the IR Light to meet the requirements of different circumstances.

- **SMART IR**

The **Smart IR** function is used to adjust the light to its most suitable intensity, and prevent the image from over exposure.

You can select the mode as **MODE 1**, or **MODE 2**.

MODE 1 is the default mode that can be applied to both indoor conditions, and outdoor conditions. When selecting the **MODE 1**, the IR Light has more obvious effects.

- **LEVEL**

The **LEVEL** value can be adjusted from 0 to 3. The greater the value is, the more obvious effects are.

- **D-N THRESHOLD (Day to Night Threshold)**

Day to Night Threshold is used to control the sensitivity of switching the day mode to the night mode. You can

set the value from 1 to 9. The larger the value is, the more sensitive the camera is.

- **N-D THRESHOLD (Night to Day Threshold)**

Night to Day Threshold is used to control the sensitivity of switching the night mode to the day mode. You can set the value from 1 to 9. The larger the value is, the more sensitive the camera is.

2.3 VIDEO SETTINGS

Move the cursor to **VIDEO SETTINGS** and click **Iris+** to enter the submenu. **IMAGE MODE**, **WHITE BALANCE**, **BRIGHTNESS**, **CONTRAST**, **SHARPNESS**, **SATURATION**, **3DNR**, and **MIRROR** are adjustable.

VIDEO SETTINGS	
IMAGE MODE	◀ STD ▶
WHITE BALANCE	↵
BRIGHTNESS	◀ 5 ▶
CONTRAST	◀ 5 ▶
SHARPNESS	◀ 5 ▶
SATURATION	◀ 5 ▶
3DNR	◀ 5 ▶
MIRROR	◀ OFF ▶
BACK	↵
EXIT	↵
SAVE & EXIT	↵

Figure 2-5 VIDEO SETTINGS

IMAGE MODE

IMAGE MODE is used to adjust the image saturation, and you can set it as **STD** (Standard), or **HIGH-SAT** (High Saturation).

WHITE BALANCE

White balance, the white rendition function of the camera, is to adjust the color temperature according to the environment. It can remove unrealistic color casts in the image. You can set the mode as **AUTO**, or **MANUAL**.

- **AUTO**

Under **AUTO** mode, white balance is being adjusted automatically according to the color temperature of the scene illumination.

- **MANUAL**

You can set the **R-GAIN/B-GAIN** value from 1 to 255 to adjust the shades of red/blue color of the image.

WHITE BALANCE	
MODE	◀ MANUAL ▶
R-GAIN	◀ 5 ▶
B-GAIN	◀ 5 ▶
BACK	↵
EXIT	↵
SAVE & EXIT	↵

Figure 2-6 MANUAL MODE

BRIGHTNESS

Brightness refers to the brightness of the image. You can set the **BRIGHTNESS** value from 1 to 9 to darken or brighten the image. The higher the value is, the brighter the image is.

CONTRAST

This feature enhances the difference in color and light between parts of an image. You can set the **CONTRAST** value from 1 to 9.

SHARPNESS

Sharpness determines the amount of detail an imaging system can reproduce. You can set the **SHARPNESS** value from 1 to 9.

SATURATION

Adjust this feature to change the saturation of the color. The value ranges from 1 to 9.

3DNR (Digital Noise Reduction)

The **3DNR** function can decrease the noise effect, especially when capturing moving images in poor light conditions and delivering more accurate and sharp image. You can set the **3DNR** value from 1 to 9.

MIRROR

OFF, **H**, **V**, and **HV** are selectable for mirror.

OFF: The mirror function is disabled.

H: The image flips 180° horizontally.

V: The image flips 180° vertically.

HV: The image flips 180° both horizontally and vertically.

2.4 FACTORY DEFAULT

Reset all the settings to the factory default.

2.5 EXIT

Move the cursor to **EXIT** and click Iris+ to exit the menu.

2.6 SAVE & EXIT

Move the cursor to **SAVE & EXIT** and click Iris+ to save the settings, and exit the menu.