

N°	Descrizione	Description
1	Chiusura a leva	Lever lock
2	Maniglione	Handle
3	Molla a gas	Gas spring
4	Maniglia corta sinistra	Left short handle
5	Gradino di sbarco (optional)	Ceiling landing step (optional)
6	Maniglia corta destra	Right short handle
7	Tenditore di sostegno	Turnbuckle support
8	Tondo di scorrimento	Scroll rod
9	Elle di tenuta	'L' base
10	Alimentatore 110/220 Volt	Power supply 110/220 Volt
11	Pannello in multistrato	Multilayer panel
12	Attuatore elettromeccanico	Linear actuator 110/220 Volt
13	Supporto gruppo scala	Cluster group support
14	Sostegno di salita destro	Right handrail
15	Ovale con attacco	Oval tubular joint
16	Pacco scala	Staircase pack
17	Ruota antiskid	Antiskid
18	Barra stabilizzatrice	Stabilizer bar
19	Radiocomando	Remote
20	Nervo-Telaio Zn 12/10	Staircase frame sinew 12/10 Zn
21	Copertura zincata a caldo	Hot-dipped galvanized roof

- E' fatto divieto di modificare o manomettere anche parzialmente la scala.
- E' fatto divieto di murare il nervo-telaio al solaio, utilizzare schiuma poliuretanic.
- Installare il nervo-telaio in bolla per garantirne un corretto funzionamento.
- Installare la scala a lavori finiti.
- Lubrificare i leverismi e tutte le cerniere della scala.
- Certificata UNI EN 14975-2010 portata Max. 260 kg.
- Il costruttore si riserva il diritto di apporre modifiche senza alcun preavviso.



- Do not tamper or modify, even partially the ladder.
- Do not wall the ladder, use polyurethane foam.
- For a proper function install the staircase frame leveled.
- Install the ladder when the work is finished.
- Lubricate levers and hinges.
- Certified UNI EN 14975-2010 Max. weight 260kg.
- Manufacturer reserves the right to modify the device at any time without notice.

Scala Retrattibile Pantografo AutoAttic Vip Terrazza - Pantograph AutoAttic Vip Terrace Ladder
 Misure espresse in centimetri - Measurements expressed in centimeters

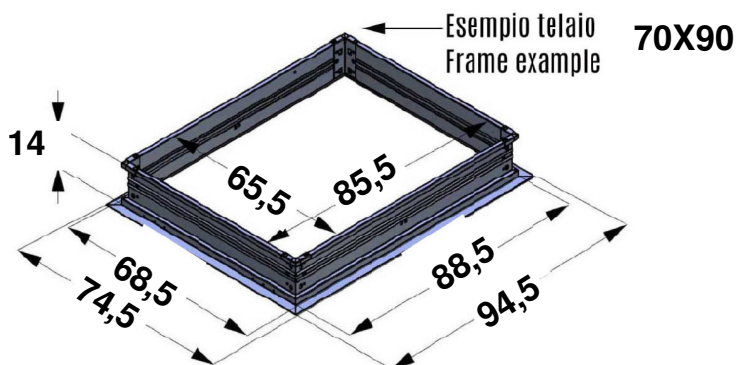
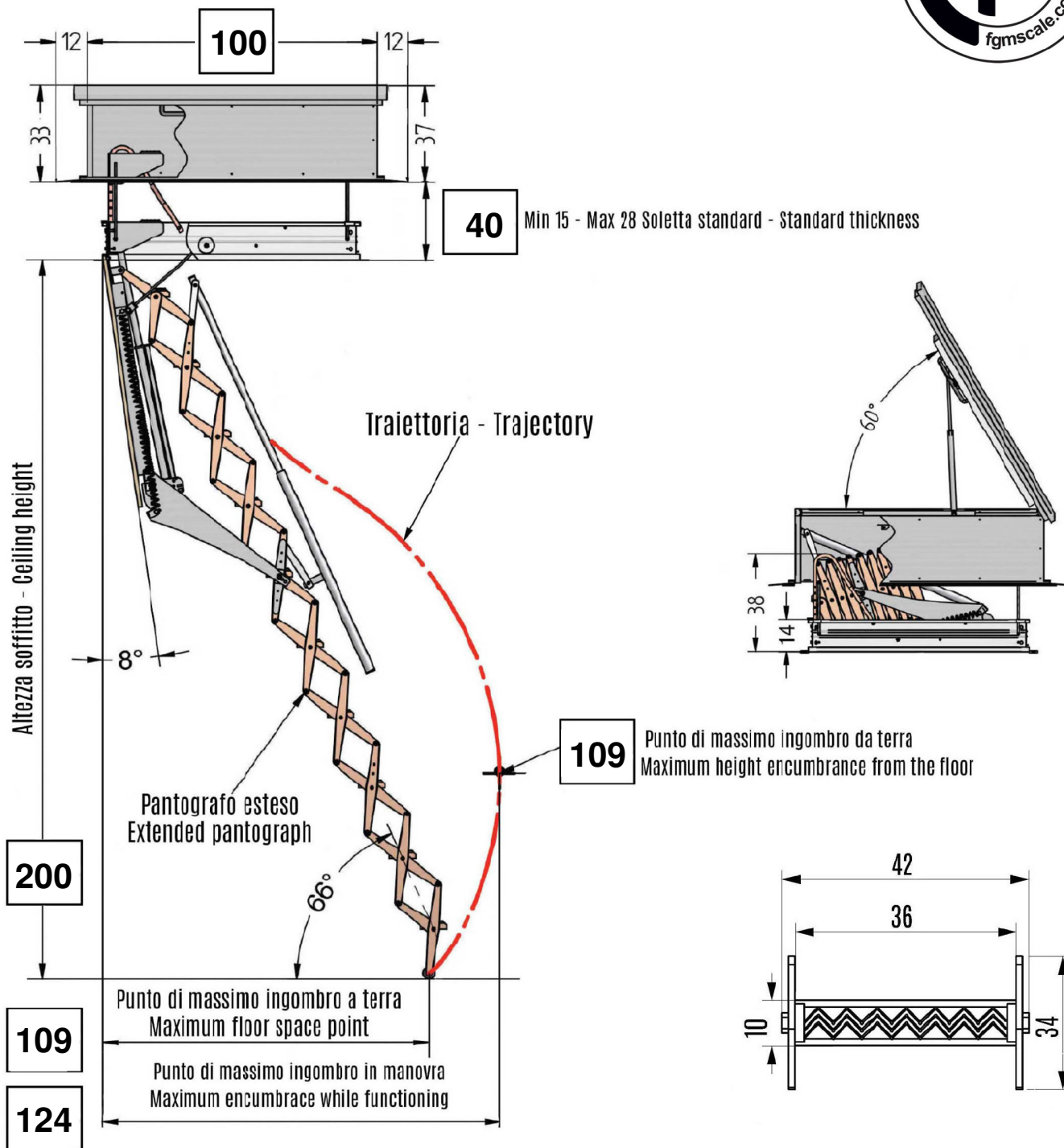



Grazie per aver scelto un prodotto ITALIANO - Thank you for buying a product made in ITALY

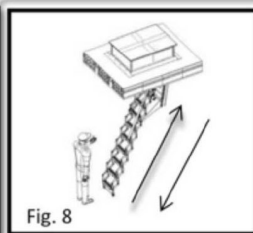
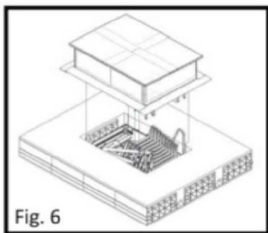
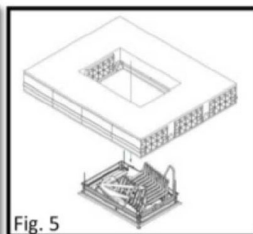
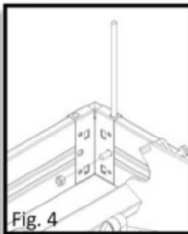
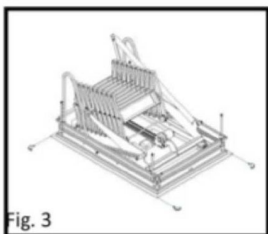
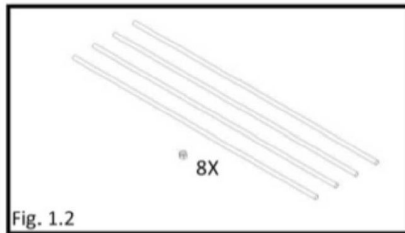
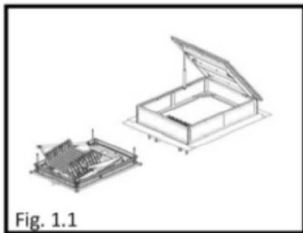

ITALIANO

1. Contenuto del pacco

- 1.1 Pacco Scala/Pacco cappello terrazza
- 1.2 Barre filettate/Dadi

2. Installazione scala

Togliere le protezioni in plastica degli spigoli del nervo-telaio. (Fig.3) Avvitare le barre filettate al nervo-telaio. (Fig.4)

Assicurarsi che il nervo-telaio sia in bolla!

Inserire, dal basso verso l'alto, il pacco scala nel foro solaio. (Fig.5) Salire sul tetto e posizionare il cappello terrazza sulle 4 barre filettate che fuoriescono dal solaio. (Fig.6) Bloccare la scala con i 4 dadi alla base del cappello terrazza. (Fig.7)

3. Apertura scala

Premere il pulsante di apertura, posto sul radiocomando per far aprire la scala. (Fig.8)

4. Chiusura scala

Premere il pulsante di chiusura, posto sul radiocomando per far chiudere la scala. (Fig.8)

Per ulteriori informazioni consultare il catalogo contenuto all'interno della scala.

ENGLISH

1. Packaging content

- 1.1 Staircase pack/Terrace hat pack
- 1.2 Filleted bars and nuts

2. Staircase pack installation

Remove the plastic protection from the corners of the staircase frame. (Fig.3) Screw the filleted bars to the staircase frame (Fig.4)

Make sure that the staircase frame is leveled!

From the bottom to the top, insert the staircase pack in the opening of the ceiling. (Fig.5) Go up to the roof and position the terrace hat on the filleted bars that come out of the ceiling. (Fig.6) Block the staircase with the 4 nuts to the base of the terrace hat. (Fig.7)

3. Ladder opening

Press the opening switch of the remote, to open the ladder. (Fig.8)

4. Ladder closing

Press the closing switch of the remote, to close the ladder. (Fig.8)

For further information please consult the contained catalogue included in the staircase package.