

Article: **NF B112KG-SAK**
Description: Modular prewired switch with adjustable shaped metal revolving lever

Sheet: 32170-0-en-2.1.0
Date: 15/01/2021
Page: 1/4



Housing:

Polymer housing, 20 mm fixing points
Protection degree: IP67 acc. to EN 60529, IP69K acc. to ISO 20653 (Protect the cables from direct high-pressure and high-temperature jets)

General data:

Corrosion resistance in saline mist: ≥ 300 hours in NSS according to ISO 9227
Max actuation frequency: 3600 operating cycles/hour
Mechanical endurance: 20 million operating cycles
B10D: 40,000,000 for NC contacts
Mechanical interlock, not coded: type 1 according to EN ISO 14119

Contact block characteristics:

| Contact block | Contact diagram | Contact design | Operation type | Positive opening \ominus | Contact type | Captive screws | Terminals with finger protection | Gold-plated contacts 1 μm | |
|---------------|-----------------|---|----------------|----------------------------|--------------|---------------------|----------------------------------|--------------------------------------|-----|
| B11 | 1NO+1NC |  | Zb | snap action | yes | Double interruption | / | / | yes |

Contact block travel diagrams:

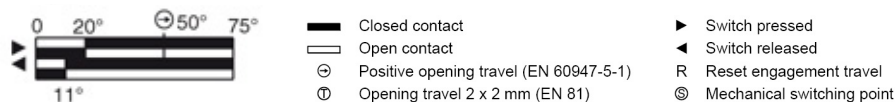

Positive switch opening:

Device with positive opening conforming to IEC 60947-5-1.

Device screw tightening torques:

Head screws: 0,3 ... 0,4 Nm
Lever screw: 0,8 ... 1,2 Nm
Connector screw: 0,2 ... 0,3 Nm
M4 fixing screws, body: 2 ... 3 Nm

Activating forces:

Min.: 0,07 Nm
Positive opening: 0,25 Nm

In conformity with standards:

IEC 60947-5-1, EN 60947-5-1, IEC 60204-1, EN 60204-1, EN ISO 14119, EN ISO 12100, IEC 60529, EN 60529, EN 50581, ISO 20653, UL 508, CSA 22.2 No.14.

In conformity with requirements requested by:

Low Voltage Directive 2014/35/EU, EMC Directive 2014/30/EU, RoHS Directive 2011/65/EU.

Markings and quality marks:



Electrical data:

Rated impulse withstand voltage (U_{imp}): 4 kV
Conditional short circuit current: 1000 A according to EN 60947-5-1
Pollution degree: 3

Important: Switch off the circuit voltage before disconnecting the connector from the switch. The connector is not suitable for separation of electrical loads. According to EN 60204-1, 2NO+2NC versions with 8-pin M12 and AMP connector can be used only in PELV circuits.

Internal connections:

1NO+1NC

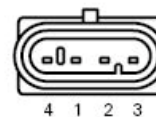

1-2 NC
3-4 NO

Article: **NF B112KG-SAK**
Description: Modular prewired switch with adjustable shaped metal revolving lever

Sheet: 32170-0-en-2.1.0
Date: 15/01/2021
Page: 2/4

Utilization temperatures and electrical data:

| | Connection type | Output with cable | | | | | | Output with M12 connector | | Output with AMP connector | |
|--|--|----------------------------|---|------------------------------|---|---|------------------------------|--|--|-----------------------------|-------|
| | Contact blocks | 2 contacts | | | 3 contacts | 4 contacts | | 2 contacts | 3 or 4 contacts | 2 contacts | |
| | Cable or connector type | E | N | H | N | N | H | M12 connector, 5-pole | M12 connector, 8-pole | AMP Superseal 1.5 connector | |
| Cable features | Conductors | 4x0.75 mm ² | 4x0.75 mm ² | 4x0.75 mm ² | 6x0.5 mm ² | 8x0.34 mm ² | 8x0.34 mm ² | 4x0.34 mm ² | 8x0.25mm ² | | |
| | Application field | General | General | General, mobile installation | General | General | General, mobile installation | General | General | General | |
| | In compliance with standards | H05VV-F | H05VV5-F | 05EQ-H | 03VV-F | 03VV-F | 03E7Q-H | 03VV-H | 03VV-H | / | |
| | Sheath | PVC | PVC OIL RESISTANT | PUR HALOGEN FREE | PVC OIL RESISTANT | PVC OIL RESISTANT | PUR HALOGEN FREE | PVC OIL RESISTANT | PVC OIL RESISTANT | / | |
| | Self-extinguishing | IEC 60332-1-2 | IEC 60332-1-2 UL 758:FT1 CEI 20-22 II | IEC60332-1-2 UL 758:FT1 | IEC 60332-1-2 UL 758:FT1 CEI 20-22 II | IEC 60332-1-2 UL 758:FT1 CEI 20-22 II | IEC 60332-1-2 UL 758:FT1 | IEC60332-1-2 UL 758:FT1 CEI 20-22 II | IEC60332-1-2 UL 758:FT1 CEI 20-22 II | / | |
| | Oil resistant | / | UL 758 CSA 22.2 N°210 | UL 758 CSA 22.2 N°210 | UL 758 CSA 22.2 N°210 | UL 758 CSA 22.2 N°210 | UL 758 CSA 22.2 N°210 | UL 758 CSA 22.2 N°210 | UL 758 CSA 22.2 N°210 | / | |
| | Max. speed | / | / | 300 m/min | / | / | 300 m/min | 50 m/min | 50 m/min | / | |
| | Max. acceleration | / | / | 30 m/s ² | / | / | 30 m/s ² | 5 m/s ² | 5 m/s ² | / | |
| | Minimum bending radius | 70 mm | 70 mm | 70 mm | 108 mm | 108 mm | 70 mm | 75 mm | 90 mm | / | |
| | Outer diameter | 7 mm | 7 mm | 7 mm | 7 mm | 7 mm | 7 mm | 6 mm | 6 mm | / | |
| End stripped | 80 mm | 80 mm | 80 mm | 80 mm | 80 mm | 80 mm | / | / | / | | |
| Copper conductors IEC 60228 | Class 5 | Class 5 | Class 6 | Class 5 | Class 5 | Class 6 | Class 6 | Class 6 | / | | |
| Engraving | Standard | 6266 | 6279 | 6272 | 6276 | 6283 | 6263 | 6275 | / | | |
| Ambient temperature with cable extended (T ₆) standard | Cable, fixed installation | -15°C +60°C | -25°C +80°C | -25°C +80°C | -25°C +80°C | -25°C +80°C | -25°C +80°C | -25°C +80°C | -25°C +80°C | / | |
| | Cable, flexible installation | +5°C +60°C | -5°C +80°C | -25°C +80°C | -5°C +80°C | -5°C +80°C | -25°C +80°C | -15°C +80°C | -15°C +80°C | / | |
| | Cable, mobile installation | / | / | -25°C +80°C | / | / | -25°C +80°C | -15°C +80°C | -15°C +80°C | / | |
| | Cable, fixed installation | / | / | -40°C +80°C | / | / | -40°C +80°C | / | / | / | |
| | Cable, flexible installation | / | / | -40°C +80°C | / | / | -40°C +80°C | / | / | / | |
| | Cable, mobile installation | / | / | -40°C +80°C | / | / | -40°C +80°C | / | / | / | |
| Electrical data | Thermal current I _{th} | 10 A | 10 A | 10 A | 6 A | 3 A | 3 A | 4 A | 2 A | 10 A | |
| | Rated insulation voltage U _i | 250 Vac | 250 Vac | 250 Vac | 250 Vac | 250 Vac | 250 Vac | 250 Vac 300 Vdc | 30 Vac 36 Vdc | 250 Vac 300 Vdc | |
| | Protection against short circuits (fuse) | 10 A 500 V type gG | 10 A 500 V type gG | 10 A 500 V type gG | 6 A 500 V type gG | 3 A 500 V type gG | 3 A 500 V type gG | 4 A 500 V type gG | 2 A 500 V type gG | 10 A 500 V type gG | |
| | Utilization category DC13 | 24 V | 2 A | 2 A | 2 A | 2 A | 2 A | 2 A | 2 A | 2 A | 2 A |
| | | 125 V | 0.4 A | 0.4 A | 0.4 A | 0.4 A | 0.4 A | 0.4 A | 0.4 A | / | 0.4 A |
| | | 250 V | 0.3 A | 0.3 A | 0.3 A | 0.3 A | 0.3 A | 0.3 A | 0.3 A | / | 0.3 A |
| | Utilization category AC15 | 24 V | 4 A | 4 A | 4 A | 4 A | 3 A | 3 A | 4 A | 2 A | 4 A |
| 120 V | | 4 A | 4 A | 4 A | 4 A | 3 A | 3 A | 4 A | / | 4 A | |
| 250 V | | 4 A | 4 A | 4 A | 4 A | 3 A | 3 A | 4 A | / | 4 A | |
| Approvals | CE cULus IMQ EAC CCC | CE cULus IMQ EAC CCC | CE cULus EAC | CE cULus IMQ EAC CCC | CE cULus IMQ EAC CCC | CE cULus EAC | CE cULus IMQ EAC CCC | CE cULus IMQ EAC CCC | CE cULus EAC | CE cULus EAC CCC | |

Article: **NF B112KG-SAK**
Description: Modular prewired switch with adjustable shaped metal revolving lever

Sheet: 32170-0-en-2.1.0
Date: 15/01/2021
Page: 3/4

Characteristics approved by IMQ

Rated insulation voltage (Ui): 250 Vac
Conventional free air thermal current (Ith): 10 A (1-2 contacts) / 6 A (2-3 contacts) / 4 A (4 contacts or 5-pin M12 connector)
Protection against short circuits (fuse): 10 A (1-2 contacts) / 6 A (2-3 contacts) / 4 A (4 contacts or 5-pin M12 connector), gG type
Rated impulse withstand voltage (Uimp): 4 kV
Protection degree of the housing: IP67
MA terminals (saddle clamps)
Pollution degree: 3
Utilization category: AC15 / DC13 (with connector)
Operating voltage (Ue): 250 Vac (50 Hz) / 24 Vdc (with connector)
Operating current (Ie): 3 A / 2 A (with connector)
Forms of the contact element: X, Y, X+Y, X+X, Y+Y, Y+Y+X, X+X+Y, X+X+Y+Y, Zb
Positive opening of contacts on contact blocks B01, B11, B02, B12, B21, B22, G01, G11, G02, G12, G21, G22, L01, L11, L02, L12, L21, L22, H01, H11, H02, H12, H21, H22
In conformity with standards: EN 60947-1, EN 60947-5-1 + A1:2009, fundamental requirements of the Low Voltage Directive 2006/95/EC.

Characteristics approved by UL

Electrical Ratings:
R300 pilot duty (28 VA, 125 250 Vdc)
B300 pilot duty (360 VA, 120 240 Vac) (1 cont.)
B300 pilot duty (360 VA, 120 240 Vac) (2 - 3 cont. without connector)
C300 pilot duty (180 VA, 120 240 Vac) (2 - 3 cont. with connector)
C300 pilot duty (180 VA, 120 240 Vac) (4 cont.)

Environmental Ratings:

Types 1, 4X, 6, 12, 13
Types 1, 4X "indoor use only" (1 - 2 cont. with "E" type cable)

Screws torque of the detachable connector housing nominal are 0.3 + 0.6 Nm.

Mechanical stop

Acc. to EN ISO 14119 paragraph 5.2 "the position sensors must not be used as mechanical stop".

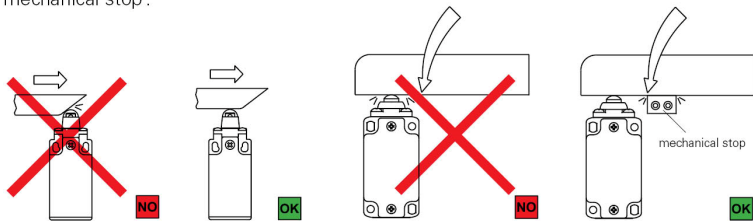

The actuator must not exceed the max. travel as indicated in the travel diagrams.

The guard must not use the switch head as a mechanical stop.

Actuation speed

| φ | Vmax (m/s) | Vmin (mm/s) | |
|-----|---------------|----------------|------|
| | | L | R |
| 15° | 2,5 | 9 | |
| 30° | 1,5 | 8 | |
| 45° | 1 | 7 | 0,07 |
| 60° | 0,75 | 7 | |

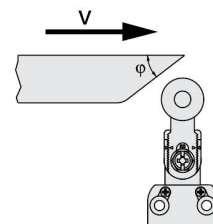

Contact type:

R = snap action
L = slow action

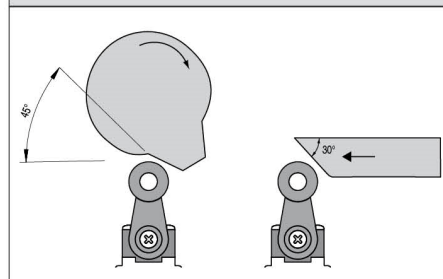
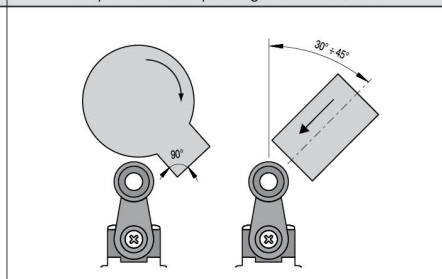
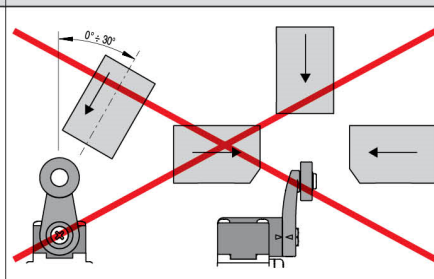

Actuation modes

| Recommended application | Application to avoid This application is possible, but increased mechanical stress may shorten the operating life of the switch | Forbidden application |
|--|--|--|
|  |  |  |

Article: **NF B112KG-SAK**
Description: Modular prewired switch with adjustable shaped metal revolving lever

Sheet: 32170-0-en-2.1.0
Date: 15/01/2021
Page: 4/4

Installation of single switches with safety functions

- Use **only** switches with the symbol .
- Connect the safety circuit to **the NC normally closed contacts (11-12, 21-22 or 31-32)**.
- **The NO normally open contacts (13-14, 23-24, 33-34) should be used only for signalling**; these contacts are not to be connected with the safety circuit. However, if two or more switches are used on the same guard, a connection can be established between the NO contacts and the safety circuit.
In this case at least one of the two switches must have positive opening and a normally closed contact NC (11-12, 21-22 or 31-32) must be connected to the safety circuit.
- Actuate the switch **at least up to the positive opening travel** shown in the travel diagrams with symbol .
- The actuation system must be able to exert a force that is greater than the **positive opening force**, as specified in brackets below each article, next to the minimum force value.
- The device must be affixed in compliance with EN ISO 14119.

Whenever the machine guard is opened and during the whole opening travel, **the switch must be pressed directly** (fig. 1) **or through a rigid connection** (fig. 2).

Only in this way the positive opening of the normally closed NC contacts (11-12, 21-22, 31-32) is guaranteed.

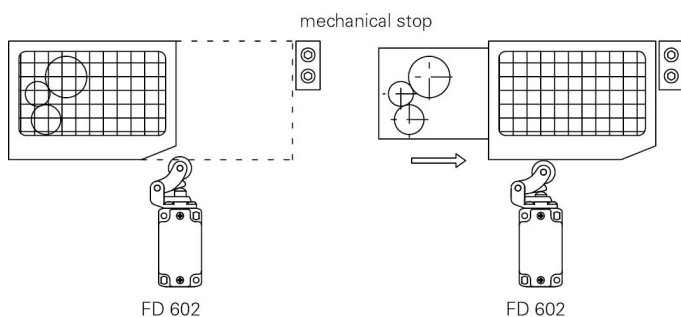

Fig.1

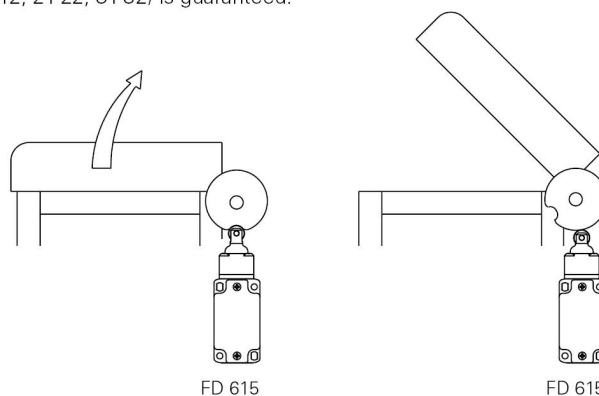

Fig.2

In safety applications with only one switch for each guard, the switches **must never be activated by a release** (fig. 3 and 4) **or through a non rigid connection** (i.e. by a spring).

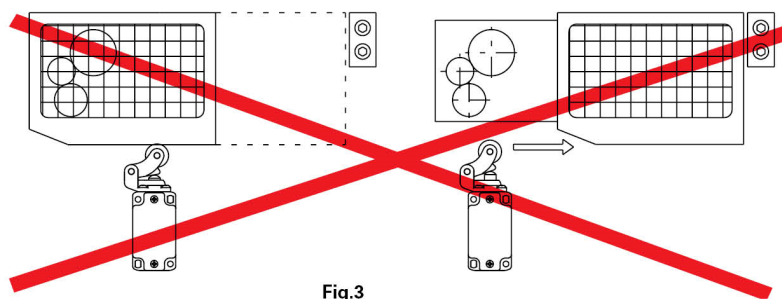

Fig.3

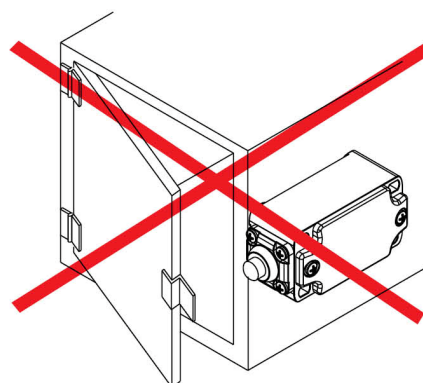

Fig.4