

FC6I/0B-0304-1F

fork sensors



Micro Detectors

Italian Sensors Technology

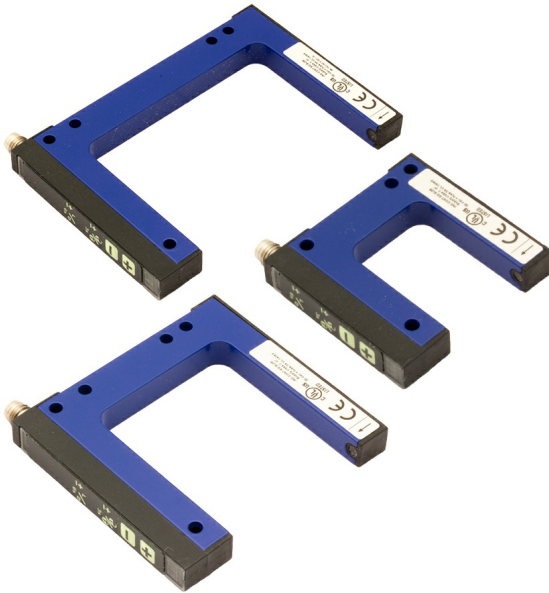

Indicative image

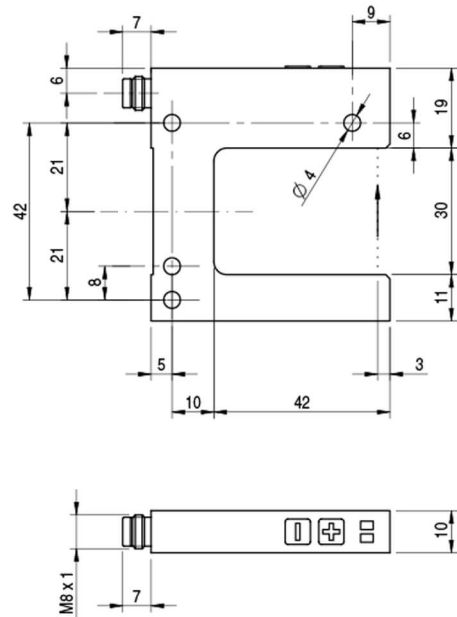

Detection properties

Nominal sensing distance	30mm
minimum detectable object	0.2mm
Sensitivity adjustment	Yes

Outputs

Output type	NPN + PNP
Output Function	LO/DO
Switching frequency	10kHz

Electrical data

Operating Voltage	12...24Vdc
No-Load supply current	40mA
Load current	100mA

Output voltage drop	≤ 2V @ IL =100 mA
Max ripple content	≤ 10%
Short-circuit protection	Yes
Reverse Polarity Protection	Yes
Emission	Infrared LED, modulated
Interference to external light	5000lux (incandescent lamp), 10000lux (sunlight)

Mechanical data

Width slot detection	30mm
Depth slot detection	42mm
Dimensions	Width slot detection 30mm - Depth slot detection 42mm
Weight	66g
Housing Material	Painted aluminium
Connections	M8 plug 4 pin
Active Head Material	Polyamide/glass
Operating temperature	- 20°C...+ 60°C
Storage temperature	- 30°C...+ 80°C

Test/Approvals

Approvals	CE UL
EMC compatibility	EN 60947-5-2
Degree of protection	IP65

ELECTRICAL DIAGRAMS OF THE CONNECTIONS

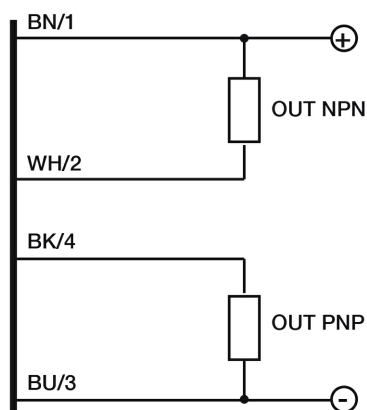

CONNECTOR

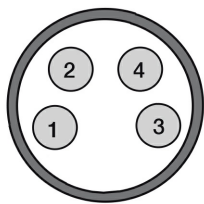

M.D. Micro Detectors S.p.A.

Strada S.Caterina, 235

41122 Modena (MO)

Tel. 059 420411

Fax 059 253973

E-mail info@microdetectors.com

date of printing

11/12/2020 09:44:17