

High-power 1550nm Fiber Amplifier Manual

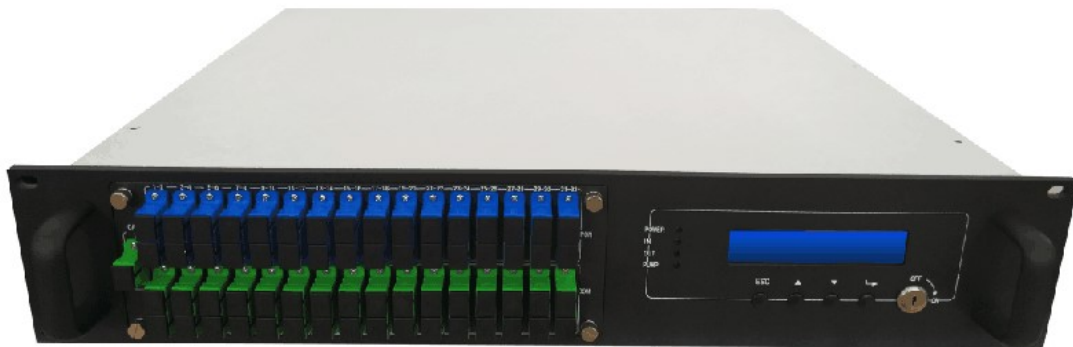

2013.6 (Version 1)

Table of Contents

Table of Contents	- 1 -
Foreword	- 2 -
1. Application	- 3 -
2. Performance Characteristics.....	- 3 -
3. Block diagram	- 4 -
4. Technique Parameter	- 5 -
4.1 Technique Parameter	- 5 -
4.2 Model and Power Comparison Table	- 6 -
5. External Function Description	- 7 -
5.1 Front Panel Description.....	- 7 -
5.2 Rear Panel Description.....	Ошибка! Закладка не определена.
5.2.1 DC Power Module Introduction.....	Ошибка! Закладка не определена.
6. Menu System.....	- 7 -
6.1 Main Menu.....	Ошибка! Закладка не определена.
6.2 Display Menu	Ошибка! Закладка не определена.
6.3 Setup Menu	Ошибка! Закладка не определена.
6.4 Warning menu	- 13 -
7. Communication Setup Descriptions.....	- 13 -
7.1 Communication Interface Description.....	- 12 -
7.2 The management and application of network interface.....	- 14 -
7.2.1 Support large network management platform for monitoring.....	- 15 -
7.2.2 Support web browsing SNMP function.....	- 17 -
8. Installation debugging.....	- 25 -
8.1 Unpack and Check.....	- 25 -
8.2 Instruments and tools.....	- 25 -
8.3 Installation steps.....	- 25 -
9. Clean and maintenance method of the optical fiber active connector.	- 26 -
10. After-sales Service Description.....	- 26 -
11. Disclaimer.....	- 27 -

Foreword

This manual applies to fiber amplifier. It mainly describes the performance characteristics, technical parameters, installation and debugging, common troubleshooting, and other related content of the product. In order to ensure that the equipment can be successfully installed and safely operated, please read this manual carefully before installing and debugging the equipment. And the installation and debugging should be strictly according to the specified steps on the manual to avoid unnecessary damage to equipment or accident harm to the operator. Any questions, please contact with us in time.

Special Tips:

- Er Yb Codoped Fiber Amplifier is high end professional equipment, and its installation and debugging must be operated by special technician. Read this manual carefully before operating to avoid damage to equipment caused by fault operation or accident harm to the operator.
- While the fiber amplifier is working, there is an invisible laser beam from the optical output adapter on the front panel. Avoiding permanent harm to the body and eye, the optical output should not aim at the human body and human should not look directly at the optical output with the naked eye!
- Please make sure that the ground terminal of the case and power outlet has been reliably grounding before turning on the power (Grounding resistance should be $< 4\Omega$) to prevent the static damage the pump laser device and harm to human because of case charged.
- To ensure the equipment can work stable over a long time, in voltage unsteady or poor voltage wave region, it's recommend to the customer that he equips special AC regulated power supply, or even AC uninterrupt power supply (UPS) system for conditional users. In the region with large temperature variation environment (The equipment's ideal work environment temperature is 25°C) or bad room environment, it's recommend to the customer that he equips special air-condition system to improve the work environment.

1. Application

- Single-mode fiber 1550 amplification network
- FTTH network
- CATV network
- Long distance trunk network.FTTx PON, max working wavelength: 1529.16~1563.86nm.
- All kinds of SDH/PDH transmission system.

2. Performance Characteristics

- Built-in optical fwm,it can transmit broadband network and CATV together.
- Adopts Er Yb Codoped double-clad fiber technology;
- Catv input ports: 1 optional
- Olt input ports: 4-32 optional
- Com Output ports: 4-32 optional;
- Optical output power: total output up to 15W (41dBm) ;
- Low noise figure: <6dB when input is 0dBm;
- Perfect network management interface, in line with standard SNMP network management;
- Intelligent temperature control system make the power consumption lower;

3. Block diagram

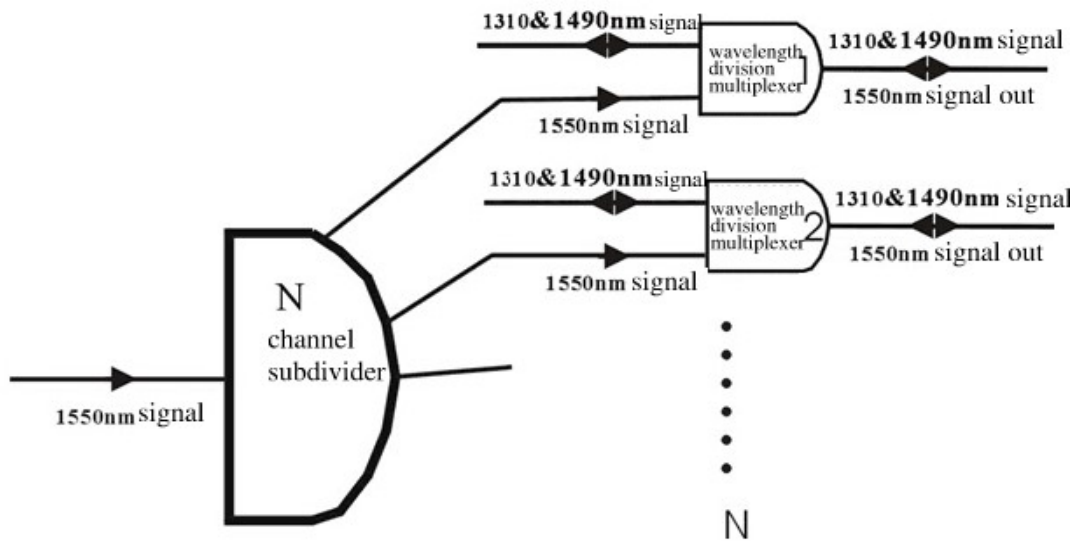
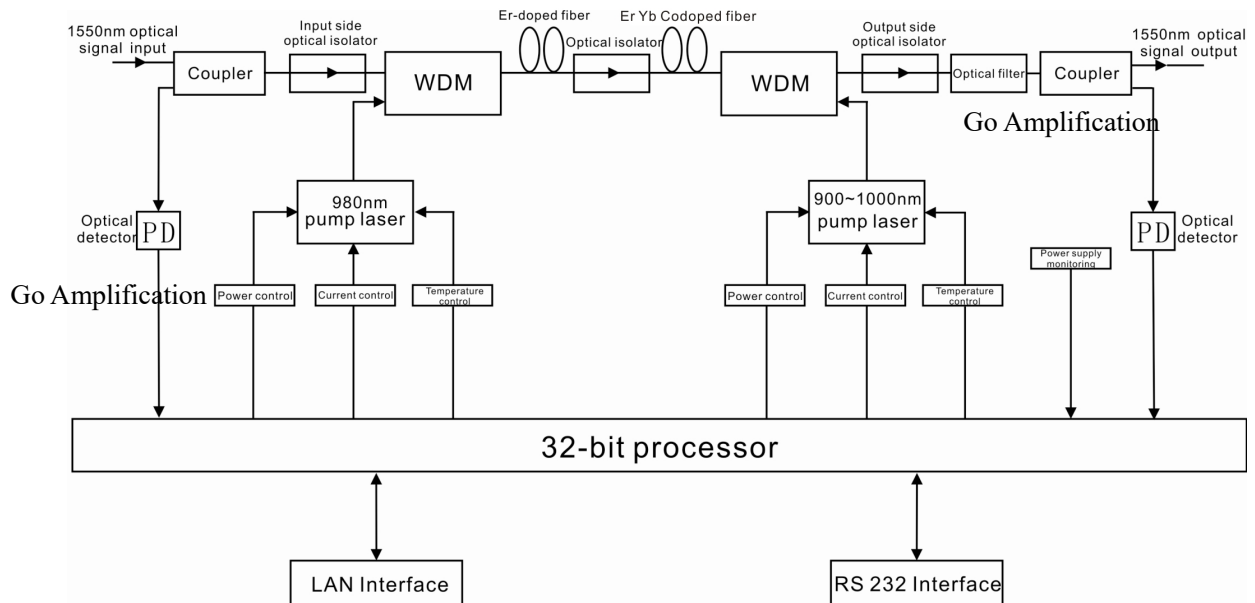

Internal integrated Fwdm structure

4 Technique Parameter

4.1 Technique Parameter

Item		Unit	Technique parameters	Remark
Operating bandwidth		nm	1545 - 1565	
Optical input power range		dBm	-3 - +10	Max rang:-10-+10
Optical Switching time		ms	≤ 5	
Maximum optical output power		dBm	41	
Output power stability		dBm	± 0.5	
Noise figure		dB	≤ 6.0	Optical input power 0dBm, $\lambda=1550\text{nm}$
Return loss	Input	dB	≥ 45	
	Output	dB	≥ 45	
Optical Connector Type			CATV IN:SC/APC, PON:SC/PC OR LC/PC COM:SC/APC OR LC/APC	
PON to COM port insertion loss			≤ 1.0	dBm
C/N		dB	≥ 50	Test condition according to GT/T 184-2002.
C/CTB		dB	≥ 63	
C/CSO		dB	≥ 63	
Power supply voltage		V	A: AC100V - 260V (50 Hz~60Hz) B: DC48V(50 Hz~60Hz) C:DC12V(50 Hz~60Hz)	
Operating temperature range		$^{\circ}\text{C}$	-10 - +42	
Maximum operating relative humidity		%	Max 95% no condensation	
Maximum storage relative humidity		%	Max 95% no condensation	
Dimension		mm	483(L) \times 440(W) \times 88(H)	

4.2 Model and Power Comparison Table

Model	Total output power dBm	Output ports number	Output power per port dBm	ADD WDM
EYA-4 -18	25	4	18	17
EYA-4 -19	26	4	19	18
EYA-4 -20	27	4	20	19
EYA-4 -21	28	4	21	20
EYA-4 -22	29	4	22	21
EYA-4 -23	30	4	23	22
EYA-4 -24	31	4	24	23
EYA-8 -15	25	8	15	14
EYA-8 -16	26	8	16	15
EYA-8 -17	27	8	17	16
EYA-8 -18	28	8	18	17
EYA-8 -19	29	8	19	18
EYA-8 -20	30	8	20	19
EYA-8 -21	31	8	21	20
EYA-8 -22	32	8	22	21
EYA-8 -23	34	8	23	22
EYA-16 -15	29	16	15	14
EYA-16 -16	30	16	16	15
EYA-16 -17	31	16	17	16
EYA-16 -18	32	16	18	17
EYA-16 -19	33	16	19	18
EYA-16 -20	34	16	20	19
EYA-16 -21	35	16	21	20
EYA-16 -22	36	16	22	21
EYA-32 -15	32	32	15	14
EYA-32 -16	33	32	16	15
EYA-32 -17	34	32	17	16
EYA-32 -18	35	32	18	17
EYA-32 -19	36	32	19	18
EYA-32 -20	37	32	20	19
EYA-32 -21	38	32	21	20
EYA-32 -22	39	32	22	21
EYA-32 -23	40	32	23	22
EYA-32 -24	41	32	24	23

From PON Port to COM Port have 1dBm insert loss& 1310nm and 1490nm.

5. External Function Description

5.1 Front Panel Description

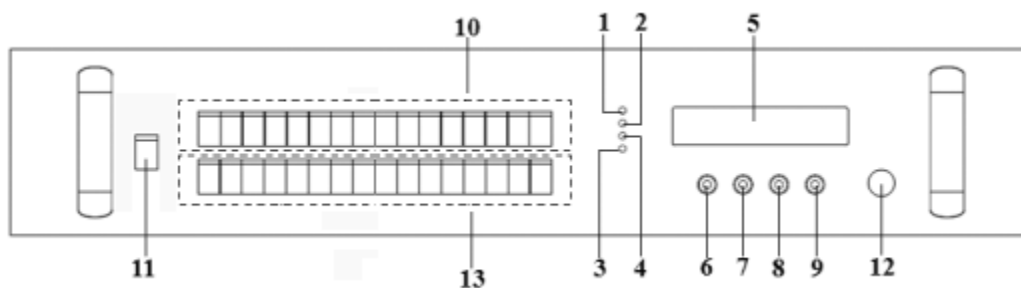

Schematic diagram of the front panel

- 1) Power indicator: One switching power supply is working – yellow; two switching power supplies are working – green.
- 2) Optical input power indicator: This light turns on when the optical input power is $> -10\text{dBm}$.
- 3) Pump working status indicator: Red light means the pump is not working, but the machine parameters are normal; flashing red light means the machine has broken down, related fault reason see the alarm menu of the display menu; green light means the pump is working normal.
- 4) Optical output power indicator: This light turns on when the optical output power is $> +10\text{dBm}$.
- 5) 160×32 dot-matrix LCD screen: used to display all the parameters of the machine.
- 6) Display the exit or cancel key of the setup menu.
- 7) Display the up or increase key of the setup menu.
- 8) Display the down or decrease key of the setup menu.
- 9) Display the enter key of the setup menu.
- 10) Optical signal output: This interface is the optical signal output port of the device. The default connector type is SC/APC; the port number is 4-32 optional. Other specification requirements are specified by the customer.
Warning: There is an invisible laser beam from this port while working normal. So the port should not be aligned to the human body or the naked eye to avoid accidental injury.
- 11) Optical signal input: The default connector type is SC/APC. Other specification requirements are specified by the customer.
- 12) Pump laser switching key: used to control the working status of pump laser. “ON” means the pump laser is open and “OFF” means the pump laser is closed. Ensure the key is on “OFF” position before power on. After passing self-test, rotate the key to “ON” position according to the displayed message.

5.2 Rear Panel Description

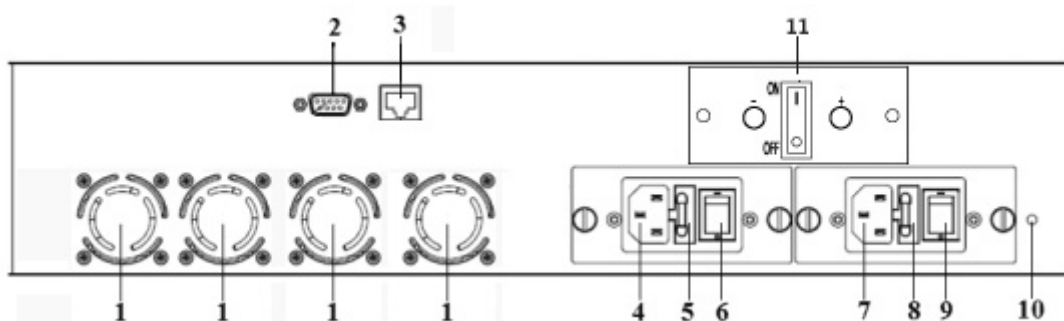

Schematic diagram of the rear panel

- 1) Fan outlet.
- 2) RS232 interface: Used for configuring the network management parameters.
- 3) LAN interface: correspond to IEEE802.3 10Base-T, used for network management.
- 4) The AC 220V input port of power supply 1.
- 5) The fuse of power supply 1.
- 6) The switch of power supply 1.
- 7) The AC 220V input port of power supply 2.
- 8) The fuse of power supply 2.
- 9) The switch of power supply 2.
- 10) Ground stud of the chassis: used for the connection of device and ground wire.
- 11) 12VDC Battery interface: When the machine is in normal operation, there is 12VDC voltage to the 12VDC battery. When the machine room is powered off, the battery will output 12VDC to EDFA for power supply. The power supply time depends on the storage capacity of the battery, with an average of 50W / h. If 500W battery is used, EDFA can work for 10 hours

5.2.1 DC Power Module Introduction

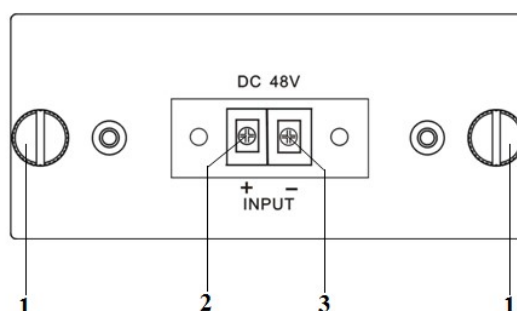

1	Mounting screws	2	+ Positive terminal block	3	- Negative terminal block
---	-----------------	---	---------------------------	---	---------------------------

6. Menu System

6.1 Main Menu

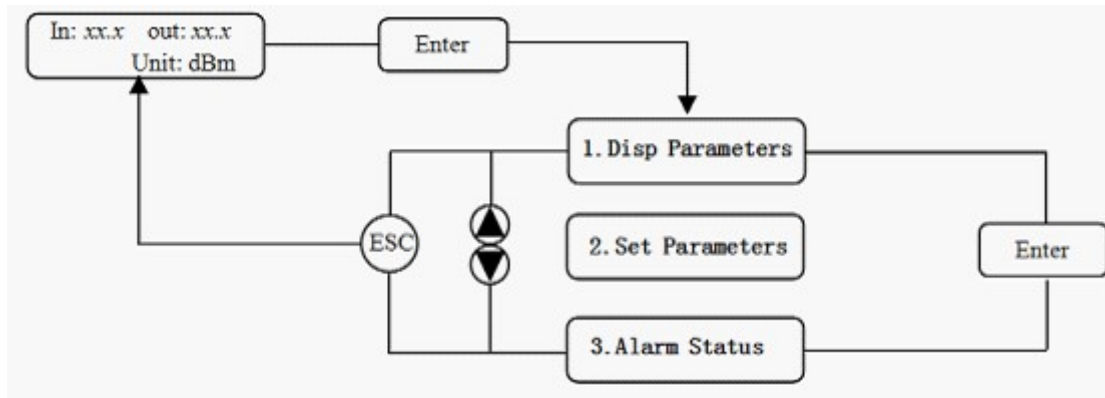

Name	Display	Description
System Starting	xxxxxx	Manufacturers' logo
	xxxxxx	Equipment model
	xxxxxx	Start countdown / lock status
Suspend Page	In: xx.x out: xx.x Unit: dBm	Display the optical input / output power
Main Page	1.Disp Parameters	Entry of parameter display menu
	2.Set Parameters	Entry of parameter setup menu
	3.Alarm Status	Entry of alarm information menu

6.2 Display Menu

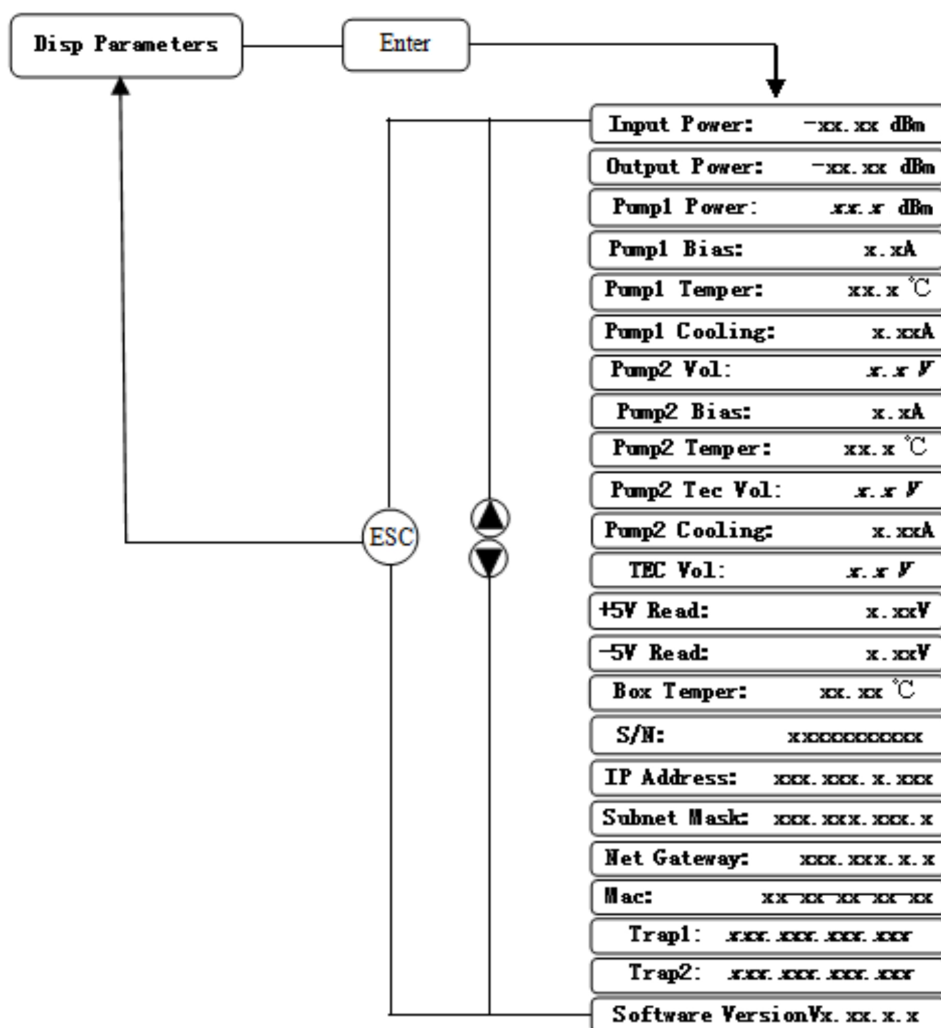

1.Disp Parameters	Input Power: xx.x dBm	Input power, accurate to 0.1 dBm
	Output Power: xx.x dBm	Output power, accurate to 0.1 dBm
	Pump1 Power: xx.x dBm	Power of pump1, accurate to 0.1 dBm
	Pump1 Bias: x.x A	Bias current of pump1, accurate to 0.1 A
	Pump1 Temper: xx.x °C	Temperature of pump1, accurate to 0.1 °C
	Pump1 Cooling: x.xx A	Cooling current of pump1, accurate to 0.01 A
	Pump2 Vol: x.x V	Drive voltage of pump2, accurate to 0.1 V
	Pump2 Bias: x.x A	Bias current of pump2, accurate to 0.1 A
	* Pump2 Temper: xx.x °C	Temperature of pump2, accurate to 0.1 °C
	* Pump2 Tec Vol: x.x V	Cooling voltage of pump2, accurate to 0.1 V
	* Pump2 Cooling: x.xx A	Cooling current of pump2, accurate to 0.01 A
	* TEC Vol: x.x V	The first stage voltage of pump2 cooler, 0.1 V
	+5V Read: x.x V	+5V power supply voltage, accurate to 0.1 V
	-5V Read: -x.x V	-5V power supply voltage, accurate to 0.1 V
	Box Temper: xx.x °C	Box temperature, accurate to 0.1 °C
	S/N: xxxxxxxx	Device serial number
	IP Address: xxx.xxx.xxx.xxx	IP address

	Subnet Mask:xxx.xxx.xxx.xxx	Subnet mask
	Net Gateway:xxx.xxx.xxx.xxx	Gateway
	Mac: xxxxxxxxxxxx	Physical address
	Trap1: xxx.xxx.xxx.xxx	trap1 address
	Trap2: xxx.xxx.xxx.xxx	trap2 address
	Software Version: Vx.xx.x.x	Firmware version number

The ultra high power output EDFA no the “*” menu.

6.3 Setup Menu

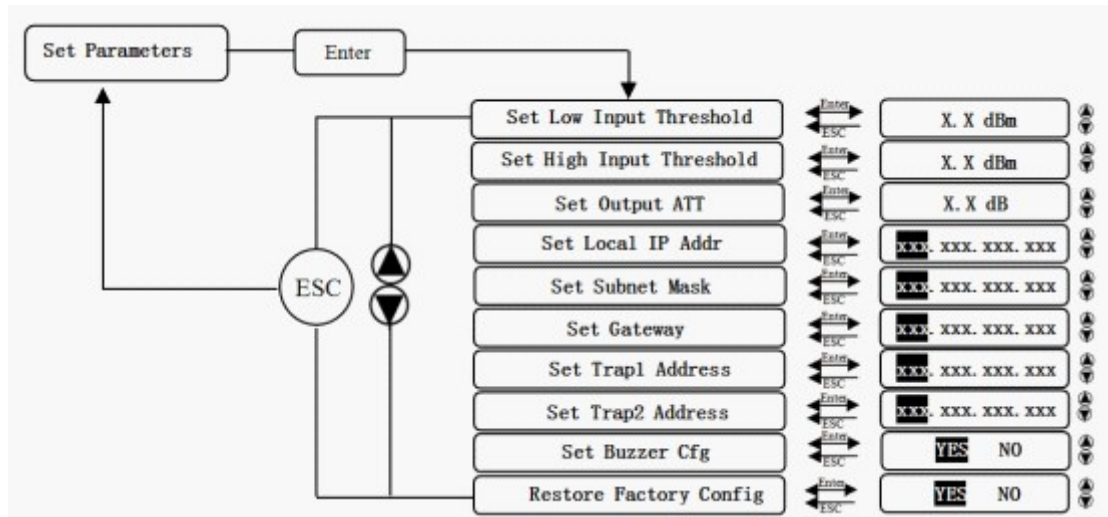

2.Set Parameters	Set Low Input Threshold	Set the low optical input power alarm threshold, range -3.0~10.0dBm
	Set High Input Threshold	Set the high optical input power alarm threshold , range -3.0~10.0dBm
	*Set Output ATT	Set the optical output power attenuation
	Set Local IP Addr	Set IP address
	Set Subnet Mask	Set subnet mask
	Set Gateway	Set gateway
	Set Trap1 Address	Set trap1
	Set Trap2 Address	Set trap2
	Set Buzzer cfg	Set the switch of beeper
	Restore Factory config	Restore the factory configuration, set content as shown above

The ultra high power output EDFA no the “*” menu.

6.4 Warning menu

3.Alarm Status	Input Status: xxx	xxx= <i>LOLOW</i> :	Very low optical input power alarm
		xxx= <i>LOW</i> :	Low optical input power alarm
		xxx= <i>HIGH</i> :	High optical input power alarm
		xxx= <i>HIHIGH</i> :	Very high optical input power alarm
	Output Status: xxx	xxx= <i>LOLOW</i> :	Very low optical output power alarm
		xxx= <i>LOW</i> :	Low optical output power alarm
		xxx= <i>HIGH</i> :	High optical output power alarm
		xxx= <i>HIHIGH</i> :	Very high optical output power alarm
	Pumpx Power: xxx	xxx= <i>LOLOW</i> :	Very low power of pump x alarm
		xxx= <i>LOW</i> :	Low power of pump x alarm
		xxx= <i>HIGH</i> :	High power of pump x alarm
		xxx= <i>HIHIGH</i> :	Very high power of pump x alarm
	Pumpx Bias: xxx	xxx= <i>LOLOW</i> :	Very low bias current of pump x alarm
		xxx= <i>LOW</i> :	Low bias current of pump x alarm
		xxx= <i>HIGH</i> :	High bias current of pump x alarm
		xxx= <i>HIHIGH</i> :	Very high bias current of pump x alarm
	Pumpx Temper: xxx	xxx= <i>LOLOW</i> :	Very low temperature of pump x alarm
		xxx= <i>LOW</i> :	Low temperature of pump x alarm
		xxx= <i>HIGH</i> :	High temperature of pump x alarm
		xxx= <i>HIHIGH</i> :	Very high temperature of pump x alarm
	Pumpx Tec: xxx	xxx= <i>LOLOW</i> :	Very low cooling current of pump x alarm
		xxx= <i>LOW</i> :	Low cooling current of pump x alarm
		xxx= <i>HIGH</i> :	High cooling current of pump x alarm
		xxx= <i>HIHIGH</i> :	Very high cooling current of pump x alarm
	+5V Status: xxx	xxx= <i>LOLOW</i> :	Very low +5V DC power supply alarm
		xxx= <i>LOW</i> :	Low +5V DC power supply alarm
		xxx= <i>HIGH</i> :	High +5V DC power supply alarm
		xxx= <i>HIHIGH</i> :	Very high +5V DC power supply alarm
	-5V Status: xxx	xxx= <i>LOLOW</i> :	Very low -5V DC power supply alarm
		xxx= <i>LOW</i> :	Low -5V DC power supply alarm
		xxx= <i>HIGH</i> :	High -5V DC power supply alarm
		xxx= <i>HIHIGH</i> :	Very high -5V DC power supply alarm
Device Temper: xxx	xxx= <i>LOLOW</i> :	Very low chassis temperature alarm	
	xxx= <i>LOW</i> :	Low chassis temperature alarm	
	xxx= <i>HIGH</i> :	High chassis temperature alarm	
	xxx= <i>HIHIGH</i> :	Very high chassis temperature alarm	

6.4 Warning menu

A Input Optical: xxx	xxx= LOW:	Optical switch Low input power alarm
	xxx= HIGH:	Optical switch High input power alarm
B Input Optical: xxx	xxx= LOW:	Optical switch Low input power alarm
	xxx= HIGH:	Optical switch High input power alarm
A Input RF: xxx	xxx= LOW:	Optical switch Low input RF alarm
	xxx= HIGH:	Optical switch High input RF alarm
B Input RF: xxx	xxx= LOW:	Optical switch Low input power alarm
	xxx= HIGH:	Optical switch High input power alarm
Input Status: xxx	xxx= LOW:	Edfa Low optical input power alarm
	xxx= HIGH:	Edfa High optical input power alarm
Output Status: xxx	xxx= LOW:	Low optical output power alarm
	xxx= HIGH:	High optical output power alarm
Pumpx Bias: xxx	xxx= LOW:	Low bias current of pump x alarm
	xxx= HIGH:	High bias current of pump x alarm
Pumpx Temper: xxx	xxx= LOW:	Low temperature of pump x alarm
	xxx= HIGH:	High temperature of pump x alarm
Pumpx Tec: xxx	xxx= LOW:	Low cooling current of pump x alarm
	xxx= HIGH:	High cooling current of pump x alarm
+5V Status: xxx	xxx= LOW:	Low +5V DC power supply alarm
	xxx= HIGH:	High +5V DC power supply alarm
-5V Status: xxx	xxx= LOW:	Low -5V DC power supply alarm
	xxx= HIGH:	High -5V DC power supply alarm

7. Communication Setup Descriptions

7.1 Communication Interface Description

1) RS232 communication interface

Adopt DB9 standard connector, the pin definitions as follow:

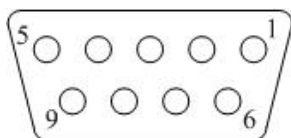

1: No Connect

2: TX

3: RX

4: No Connect

5: GND

6: No Connect

7: No Connect

8: No Connect

9: No Connect

The serial communication uses the sscm App, bit and the baud rate is 19200.

SSCOM V5.13.1 Serial/Net data debugger, Author: Tintin, 2618058@qq.com



PORT COM_Settings Display Send_Data Multi_Strings Tools Help

▲PCB打样降至每款30元顺丰包邮! 【嘉立创官网】

Main data display area, currently empty.

ClearData OpenFile

SendFile

Stop

ClearSend

OnTop

English

SaveConfig

EXT



2) LAN communication interface

Adopt RJ45 standard connector, the pin definitions as follow:

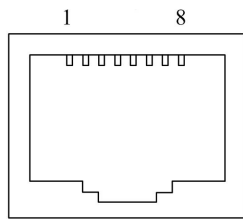

LAN

1: TX+	2: TX-	3: RX+
4: No Connect	5: No Connect	6: RX-
7: No Connect	8: No Connect	

7.2 The management and application of network interface

7.2.1 Support large network management platform for monitoring

Set up PC IP same with transponder telemetry. The IP for transponder telemetry is 192.168.0.101, the PC can be set 192.168.0.2



IP	MAC	Type	Onli...	Equipment Description	Serial Number
----	-----	------	---------	-----------------------	---------------

AddNew Transponder

Ip Address

Community(Read)

Community(Write)

OK Cancel



List

NewAlarms

HistoryAlarms

IP	MAC	Type	Onli...	Equipment Description	Serial Number
----	-----	------	---------	-----------------------	---------------

Transponder Property-[OA] \\HFCNms\192.168.0.101:161



Normal | Advance | Remark

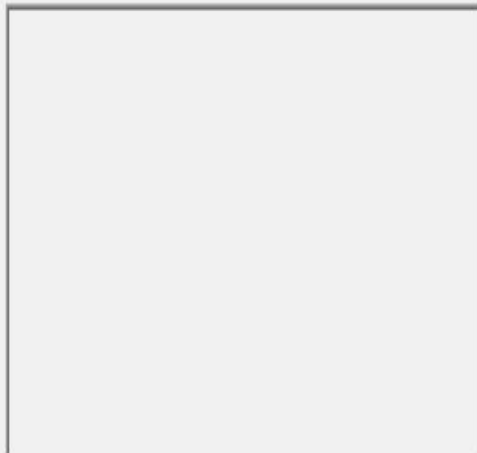

DeviceTable	ModelNo	SerialNo	IntTemp(C)	DeviceFW
Channel1	EYA1550-64*19dBm-FWDM-OS	JF519010301	30	V1.0.1

oaPumpTable	PumpBIAS(mA)	PumpTEC(A)	PumpTemp(C)
Channel1	871	0.57	25.2
Channel2	772	1.00	25.0
Channel3	870	1.00	25.0

DC Power	Voltage(V)	Name
Channel1	4.8	DC +5V
Channel2	-4.8	DC -5V

Description	EYA1550-64*19dBm-FWDM-OS
Administrator	sysContact
NE Name	HFC-OA With OSW
Location	sysLocation
Device detail	HFC-OA
Cover Status	Compromised

OpAmpInputTable	SwitchMode	SwitchControl	SwitchState
Channel1	Automatic	PathA	PathA

OpAmpInputTable	InputOpticalLevel(dBm)	SetInputPowerThreshold(dBm)	InputS
Channel1	2.6	-10.0	Normal

DisablePolling

OK

Cancel



Major Alarm

7.2.2 Support web browsing SNMP function

Ues name:Admin Pass word:123456

Windows browser interface showing the address bar with `http://192.168.0.101/` and a search bar. A tab is open with the title "Waiting for 192.168.0.101".

Windows Security dialog box titled "iexplore".

The server 192.168.0.101 is asking for your user name and password. The server reports that it is from Embedded WEB Manager.

Warning: Your user name and password will be sent using basic authentication on a connection that isn't secure.

用户名

密码

记住我的凭据

OK Cancel

Device Status:



SNMP Agent WEB Manager

Device Status

Device Settings

Alarm Status

Alarm Properties

Network Settings

Change Password

Reset Settings

Serial Number **JF519010301**

Internal Temperature **28.8** °C

Input Power **1.5** dBm

Output Power **19.4** dBm

DC Power +5V **4.8** V

DC Power -5V **-4.8** V

Switch Source **Optical signal**

Switch Mode **Automatic**

Switch Position **Path A**

Index	Optical Input Power	Optical Threshold	Description
1	1.6 dBm	-10.0 dBm	Path A
2	2.1 dBm	-10.0 dBm	Path B

Index	RF Level	RF Threshold	Description
-------	----------	--------------	-------------

Device Settings:



SNMP Agent WEB Manager

Device Status

Device Settings

Alarm Status

Alarm Properties

Network Settings

Change Password

Reset Settings

Device Settings

PUMP Status:

Set Output: dB

Switch Source:

Switch Mode:

Switch To:

Optical Threshold: dBm

RF Threshold: dBuV

Submit

Alarm Status



SNMP Agent WEB Manager

Device Status

Device Settings

Alarm Status

Alarm Properties

Network Settings

Change Password

Reset Settings

Alarm Status

Index	Parameter Name	Alarm Status
1	Output optical power	Nominal
2	Input optical power	Nominal
3	Box Temp	Nominal
4	Pump1 BIAS	Nominal
5	Pump2 BIAS	Nominal
6	Pump1 TEC	Nominal
7	Pump2 TEC	Nominal
8	Pump1 Temp	Nominal
9	Pump2 Temp	Nominal
10	DC +5V	Nominal
11	DC -5V	Nominal

Alarm Properties



SNMP Agent WEB Manager

Device Status

Device Settings

Alarm Status

Alarm Properties

Network Settings

Change Password

Reset Settings

Alarm Properties

Index	Parameter Name	HIHI	HI	LO	LOLO	Deadband	Action
1	Output optical power (dBm)	<input checked="" type="checkbox"/> 27.0	<input checked="" type="checkbox"/> 26.0	<input checked="" type="checkbox"/> 11.0	<input checked="" type="checkbox"/> 10.0	1.0	Set
2	Input optical power (dBm)	<input checked="" type="checkbox"/> 10.0	<input checked="" type="checkbox"/> 8.0	<input checked="" type="checkbox"/> -5.0	<input checked="" type="checkbox"/> -10.0	1.0	Set
3	Box Temp (°C)	<input checked="" type="checkbox"/> 85	<input checked="" type="checkbox"/> 70	<input checked="" type="checkbox"/> 0	<input checked="" type="checkbox"/> -5	2	Set
4	Pump1 BIAS (mA)	<input checked="" type="checkbox"/> 1200	<input checked="" type="checkbox"/> 1000	<input checked="" type="checkbox"/> 100	<input checked="" type="checkbox"/> 80	10	Set
5	Pump2 BIAS (mA)	<input checked="" type="checkbox"/> 1200	<input checked="" type="checkbox"/> 1000	<input checked="" type="checkbox"/> 100	<input checked="" type="checkbox"/> 80	10	Set
6	Pump1 TEC (A)	<input checked="" type="checkbox"/> 2.00	<input checked="" type="checkbox"/> 1.50	<input checked="" type="checkbox"/> -1.50	<input checked="" type="checkbox"/> -2.00	0.10	Set
7	Pump2 TEC (A)	<input checked="" type="checkbox"/> 2.00	<input checked="" type="checkbox"/> 1.50	<input checked="" type="checkbox"/> -1.50	<input checked="" type="checkbox"/> -2.00	0.10	Set
8	Pump1 Temp (°C)	<input checked="" type="checkbox"/> 35.0	<input checked="" type="checkbox"/> 30.0	<input checked="" type="checkbox"/> 20.0	<input checked="" type="checkbox"/> 15.0	1.0	Set
9	Pump2 Temp (°C)	<input checked="" type="checkbox"/> 35.0	<input checked="" type="checkbox"/> 30.0	<input checked="" type="checkbox"/> 20.0	<input checked="" type="checkbox"/> 15.0	1.0	Set
10	DC +5V (V)	<input checked="" type="checkbox"/> 6.5	<input checked="" type="checkbox"/> 6.0	<input checked="" type="checkbox"/> 4.0	<input checked="" type="checkbox"/> 3.5	0.2	Set
11	DC -5V (V)	<input checked="" type="checkbox"/> -3.5	<input checked="" type="checkbox"/> -4.0	<input checked="" type="checkbox"/> -6.0	<input checked="" type="checkbox"/> -6.5	0.2	Set

Index	Parameter Name	Control	Action
-------	----------------	---------	--------

Network Settings



SNMP Agent WEB Manager

Device Status

Device Settings

Alarm Status

Alarm Properties

Network Settings

Change Password

Reset Settings

Network Settings

Device MAC: 00 : B9 : A0 : 12 : 10 : 8C

Update Identifier: OA143SE01

Agent Version: V1.0.0

Static IP Address: 192 . 168 . 0 . 101

Subnet Mask: 255 . 255 . 255 . 0

Default Gateway: 192 . 168 . 0 . 1

Trap Address 1: 255 . 255 . 255 . 255

Trap Address 2: 0 . 0 . 0 . 0

Trap Address 3: 0 . 0 . 0 . 0

Trap Address 4: 0 . 0 . 0 . 0

Trap Address 5: 0 . 0 . 0 . 0

Trap Address 6: 0 . 0 . 0 . 0

Trap Address 7: 0 . 0 . 0 . 0

Trap Address 8: 0 . 0 . 0 . 0

Read Community: public

Write Community: public

Change Password



SNMP Agent WEB Manager

Device Status

Device Settings

Alarm Status

Alarm Properties

Network Settings

Change Password

Reset Settings

Change Password

Username:

Password:

New Username:

New Password:

Confirm Password:

Submit

Reset

Restet Settings



SNMP Agent WEB Manager

Device Status

Device Settings

Alarm Status

Alarm Properties

Network Settings

Change Password

Reset Settings

Restore settings and Reboot device

- Reboot device

Reboot device

- Restore factory settings

Warning!!

Click the restore button, all parameters will be restored to factory default.

Restore Factory

- Restore Net parameters:

- IP Address: 192.168.1.8
- Subnet Mask: 255.255.255.0
- Gateway Address: 192.168.1.1
- TRAP Address 1: 192.168.1.200
- TRAP Address 2: 255.255.255.255

- User parameters:

- User name: admin
- Password: 123456

Restore net

8. Installation debugging

8.1 Unpack and Check

1. Insure the package is not defaced. If it has any damage or water mark, please contact local agency or carrier.
2. After unpacking, check equipments and accessories according to package list. Any question, please contact local agency or our company.
3. If you think the equipment has been damaged, please don't electrify to avoid worse damage. Please contact local agency or our company in time.

8.2 Instruments and tools

1. An optical power meter;
2. A digital multimeter;
3. A standard optical fiber test jumper (SC/APC);
4. Some absolute alcohol and medical cotton wool;

8.3 Installation steps

1. Before installing the equipment, please read the <User's manual> carefully and install the equipment according to the <User's manual>. **Note:** For the man-made damage and other all consequence caused by error installation that not according to the <User's manual>, we will not be responsible and will not supply free warranty.
2. Take out the device from the box; fix it to the rack and reliably grounding. (The grounding resistance must be $< 4\Omega$).

3. Use the digital multimeter to check the supply voltage, make sure the supply voltage comply with the requirements and the switch key is on the “OFF” position. Then connect the power supply.
4. Input the optical signal according to the display message. Turn the switch key to the “ON” position and observe the front panel LED status. After the pump working status indicator turn into green, the device is working normal. Then press the menu button on the front panel to check the working parameters.
5. Connect the optical power meter to the optical signal output end by the standard optical fiber test jumper, then measure the optical output power. Affirm the measured optical output power and the displayed power are the same and have reached the nominal value. (Affirm the optical power meter is on 1550nm wavelength test position; the optical fiber test jumper is the matched one and on the connector surface has no pollution.) Remove the standard optical fiber test jumper and optical power meter; connect the device to the network. So far, the device has been completely installed and debugged.

9. Clean and maintenance method of the optical fiber active connector

In many times, we consider the decline of the optical power as the equipment faults, but actually it may be caused by that the optical fiber connector was polluted by dust or dirt. Inspect the fiber connector, component, or bulkhead with a fiberscope. If the connector is dirty, clean it with a cleaning technique following these steps:

1. Turn off the device power supply and carefully pull off the optical fiber connector from the adapter.
2. Wash carefully with good quality lens wiping paper and medical absorbent alcohol cotton. If use the medical absorbent alcohol cotton, still need to wait 1~2 minutes after wash, let the connector surface dry in the air.
3. Cleaned optical connector should be connected to optical power meter to measure optical output power to affirm whether it has been cleaned up.
4. When connect the cleaned optical connector back to adapter, should notice to make force appropriate to avoid china tube in the adapter crack.
5. If the optical output power is not normal after cleaning, should pull off the adapter and clean the other connector. If the optical power still low after cleaning, the adapter may be polluted, clean it. (Note: Be carefully when pull off the adapter to avoid hurting inside fiber.)
6. Use compressed air or degrease alcohol cotton to wash the adapter carefully. When use compressed air, the muzzle aims at china tube of the adapter, clean the china tube with compressed air. When use degrease alcohol cotton, insert directions need be consistent, otherwise can't reach a good clean effect.

Special notice:

- a. **In the process of clean the active optical fiber connector, you should avoid**

direct shining at eye, which will cause permanence burn!!!!

- b. Use proper energy to install the active optical connector, or the ceramic tape in the adaptor will lead to break. Once the ceramic tape is broken, the optical output power will decrease rapidly. And turn the active optical fiber connector slightly, the optical output power changes obviously.**
- c. Please operate the optical fiber under the condition of shut off the pump laser. Or the high output power will lead to burn the joint of the optical output fiber, which will cause the output power decrease.**

10. After-sales Service Description

- 1. If the equipment fault is resulted from the users' improperly operation or unavoidable environment reasons, we will responsible maintenance but ask suitable material cost.
- 2. When the equipment breaks down, immediately contact local distributor.
- 3. The site maintenance of the fault equipment must be operated by professional technicians to avoid worse damage.

Special notice: If the equipment has been maintained by users, we will not responsible free maintenance. We will ask suitable maintenance cost and material cost.

11. Disclaimer

We reserve the right to change any products described herein at any time, and without prior notice. We assume no responsibility or liability arising from the use of the products described herein, except as expressly agreed to in writing by us. The use and purchase of this product does not convey a license under any patent rights, copyrights, trademark rights, or any intellectual property rights of us. Nothing hereunder constitutes a representation or warranty that using any products in the manner described herein will not infringe any patents of third parties.