

CD08/0B-100C1

connectors



Micro Detectors

Italian Sensors Technology



Indicative image

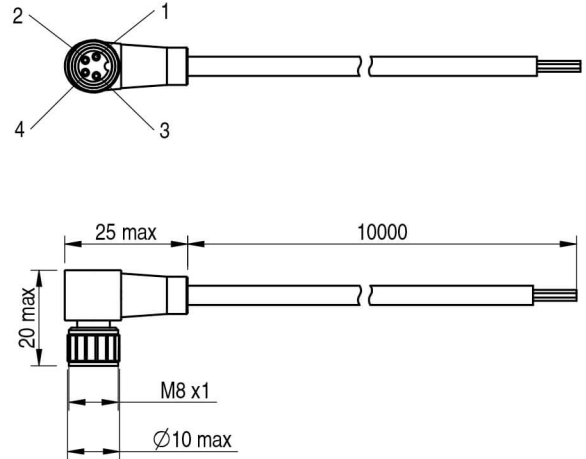

Electrical data

Nominal current	Max. 4 A
Wires	4
Rated impulse voltage	0,8 kV
Nominal voltage	Max. 50Vac / 60Vdc

Mechanical data

Connections	Pin 1: brown Pin 2: white Pin 3: blue Pin 4: black
Tightening torque	0,6 Nm
Operating temperature	-10°C...+80°C (flexible installation) -25°C...+80°C (fixed installation)
Length (m)	10
Head type	90°
Plug	M8
Outer diameter	Ø 4,7 mm ± 5%
Jacket material	PVC (CFC, cadmium, silicon, lead free) Flame retardant according to UL1581VW1/CSA FT1, self-extinguishing
Wire isolation	PVC (CFC, cadmium, silicon, lead free)
Bending radius	Wire for fixed installation: 5 x d Wire for flexible installation: 10 x d
Conductors section	0,25 mm ² (14 x 0,15 mm ²)
Model	Femmina

ELECTRICAL DIAGRAMS OF THE CONNECTIONS

BN/1

WH/2

BU/3

BK/4

M.D. Micro Detectors S.p.A.

Strada S. Caterina, 235
41122 Modena (MO)
Tel. 059 420411
Fax 059 253973
E-mail info@microdetectors.com

date of printing

01/12/2020 09:11:17