

WAGNER PRESENTS

# Contractor 2021

PRODUCT NAVIGATION











**BE UNSTOPPABLE!**

**WAGNER**

# SHORT AND SIMPLY EXPLAINED

## 1. MATERIALS

When displaying suitable materials, we shorten these for better clarity using colour codes.















 Water and solvent-based lacquers, lacquer paints, oils, separating agents	 Synthetic resin varnishes, PVC lacquers, 2K lacquers	 Primers, fillers
 Fire protection, rust protection paints	 Emulsion and latex paints, adhesives, sealants	 Exterior paints, roof coatings, floor coatings, textured paint
 Structural waterproofing, bituminous coatings	 Filler	 Plaster

## 2. RECOMMENDED INTENSITY































































































































We recommend that you select a device suited to your typical application.

 Residential	 Large residential	 Commercial
------------------------------------------------------------------------------------------------	-------------------------------------------------------------------------------------------------------	--------------------------------------------------------------------------------------------------

## 3. TECHNOLOGY

Spraying method	Technologies	Drive	Other
 XVLP / HVLP	 Piston pump	 Electric	 Explosion-protection
 FineSpray	 Diaphragm pump	 Pneumatic	 TempSpray
 AirCoat	 Double diaphragm pump	 Petrol-driven	
 Airless	 Turbine		
 Plaster spraying	 Spiral pumps		

## PUMP OVERVIEW ACCORDING TO MATERIALS

									
Finish Control 3500									
Finish Control 5000									
FineCoat 9900 Plus									
SuperFinish 23 Pro HEA									
SuperFinish 23 Plus HEA / Airless Enamel / TempSpray / Aircoat Enamel									
SuperFinish 23 CR									
SuperFinish 33 Pro									
SuperFinish 33 Plus									
PowerPainter 90 Extra									
ProSpray 3.20 HEA									
ProSpray 20 HEA									
ProSpray 3.21 HEA									
ProSpray 3.25									
ProSpray 3.31									
ProSpray 3.34									
ProSpray 3.39 Emulsion									
ProSpray 3.39 Filler									
HeavyCoat 750 E/G & E SSP									
HeavyCoat 950 E/G & E SSP									
HeavyCoat 970 E/G & E SSP									
PlastCoat HP 30									
PlastCoat 1030 E									
PlastMax									



## FURTHER TRAINING FOR CONTRACTOR WORK AND INDUSTRY

Companies that want to continue being successful in their markets in the future must continuously expand their employees' knowledge and abilities. Equipment technology represents the future of professional painting and decorating within the context of normal, efficient, high-quality site work. This is why it is particularly important to us to not only provide you with the technology but also to convey the corresponding know-how. After all, even the very best products only create the best surface when used in combination with specialist professional knowledge.

The WAGNER ACADEMY's completely new seminar programme has now been divided into four areas of application - Paint, Interior paint / adhesives, Exterior / building protection and Fillers / plaster. There are three levels: Basic, Advanced and Expert.

Whether user, plant manager, material manufacturer or sales partner - the new WAGNER ACADEMY offers every target group high-quality training modules for professional and personal further education. We advise checking the seminar calendar on page 29 directly and securing your personal training date.

**You can find more training dates online at [go.wagner-group.com/academy-handwerk](http://go.wagner-group.com/academy-handwerk). Registration and further information can also be found on our website.**

## NEW TRAINING CENTRE IN MARKDORF, BY LAKE CONSTANCE

- **Three seminar rooms with state-of-the-art presentation and conference technology**
- **Practical zone with different, mobile demo areas**
- **Technical centre for service issues**
- **Painting booth with extraction system**
- **Lounge area with cafeteria - Our trainers will be happy to invite you for a coffee!**

The team of the WAGNER ACADEMY welcomes you and your colleagues!

### WE COME TO YOU!

All training courses can also be held conveniently at your premises. Please contact us at [Academy.DF@wagner-group.com](mailto:Academy.DF@wagner-group.com) or call +49 (0) 7544 505 1602



More SprayGuides: [sprayguide.wagner-group.com](http://sprayguide.wagner-group.com)

## MACHINE & MATERIAL PERFECTLY MATCHED

The extensive WAGNER SprayGuide offers you test reports from well-known material manufacturers for use with WAGNER spray machines.

Visit [sprayguide.wagner-group.com](http://sprayguide.wagner-group.com) to find out how to set up your machine to match the material you are using, and which paints and lacquers can be sprayed most effectively with WAGNER technology.

- ➔ Search by material type
- ➔ Search by material manufacturer
- ➔ Search by WAGNER machine and systems

# INNOVATION SINCE 1947

Perfect surfaces and added value are our passion. Bringing colour, protection and function to surfaces is our mission. We dedicate all of our technical expertise to your objects and products, and support you with personal service. Using innovative technologies and highly efficient, reliable and user-friendly solutions, we are constantly setting new standards in surface technology.



Anyone purchasing a WAGNER paint spraying unit automatically receives a three-year manufacturer's warranty. But we can do more: If you register online, you can extend this warranty for a further two years, free of charge!

## HVLP / XVLP

### High air volume – low air pressure

Are you looking for a versatile spray device that offers a wide range of applications for improvement and renovation work on small to medium-sized construction sites? Then the modular low-pressure spray systems with HVLP- and XVLP technology (Xtra Volume Low Pressure) from WAGNER are perfect for you – especially in terms of quality, functionality and value for money. Low-pressure spraying involves working with a large air volume and a low air pressure (up to 0.7 bar) – which results in a high working speed and minimal overspray.

#### Particularly powerful and flexible:

In low-pressure spraying, the atomising air generated in the turbine flows through an air hose to the paint container on the spray gun, where it then builds up pressure. This delivers the coating material through the material tube to the nozzle and atomises it with the remaining air. The spray devices of the WAGNER XVLP series offer much better atomisation performance compared to other lower-pressure devices (HVLP), thanks to a 60 percent greater air volume and 30 percent more surface coverage.

#### 1. LESS OVERSPRAY:

The HVLP- and XVLP spray devices combine the positive properties of low pressure with those of a high-pressure procedure, i.e.: Less overspray and fine atomisation result in an optimised consumption of material.

#### 2. OPTIMAL ADJUSTMENT OPTIONS:

The volume of air and material can be perfectly adjusted directly on the gun and therefore quickly to various objects using a rotary control.

## APPLICATION AREA HVLP AND XVLP TECHNOLOGY

Lacquers	Enamels		Emulsions
	standard	high-viscosity	
HVLP			
XVLP			

## ADVANTAGES

- Easy to use
- Innovative nozzle technology
- Spray pattern adjustable to object
- Direct Spray Control: Settings are directly on the device
- Spraying of undiluted materials
- Quick material change through Click & Paint system (XVLP)



#### Well-equipped for daily use on construction sites:

The modular system consisting of a turbine and various spray attachments enables the application of wood stains, varnishes and lacquers through to emulsions with professional quality. Thanks to the practical Click & Paint function, the attachments can be changed with a simple movement. The XVLP devices from WAGNER are perfect when starting to use spray equipment or to add to the range of devices available on site.

#### 3. INNOVATIVE NOZZLE TECHNOLOGY:

The XVLP spray devices combine the properties of low pressure with those of a high-pressure procedure. The combination of a large air volume and innovative, Visco slot nozzle technology enables a high working speed with excellent surface quality even with highly viscous paint.

#### 4. A VARIETY OF POSSIBLE USES:

The devices are especially versatile thanks to three spray attachments – Standard-Spray, FineSpray and WallSpray – which are ideal for handling various materials. Thanks to the practical Click & Paint function, the spray attachments can be changed with a simple movement.

# FINISHCONTROL 3500 / 5000 SPRAYPACK



An all-rounder for small projects – the entry-level answer for professional coating using spray technology

- **Universally suitable:** for use with varnishes, lacquers and emulsion paints, thanks to a modular spraying attachment system for simple material changes
- **Total control:** directly on the gun
- **Extremely compact and practical**



- **Flexible:** Ideal for renovation and repair work
- **Available in two versions:** compact, hand-held unit with practical carry case or powerful with air hose and the turbine on the ground

#### The trend-setting Visco nozzle technology:

produces a particularly high-quality spray pattern. This is achieved thanks to the flat jet delivered by the slot nozzle which also ensures a high working speed

**High-performance turbine with a light weight:** Start the turbine easily on the gun by pressing the trigger into the first level. Depress the trigger completely to start the material flow

**Direct Spray Control:** FinishControl is particularly easy to use. (1) The continuously adjustable air volume and the (2) material volume control ensure a precisely tailored approach to the material. (3) The spraying level and spray pattern width can be adjusted to suit the item being coated



**Click & Paint System:** The paint-carrying spray attachment can be easily removed from the gun for easy cleaning. Additional spray attachments allow you to work with different materials and change colours rapidly



FINISHCONTROL 3500 SPRAYPACK - DPXVLP	2341501
Turbine housing with handle	-
StandardSpray spray attachment	2321879
Carrying case, for FC 3500	2341100
Air filters, 3 pieces, for FinishControl 3500	2343947
Filling hopper, 3 pieces, for FinishControl spray attachments	2324745
Carrying strap, for FC 3500	2341187
Strap holder FinishControl 3500, incl. screws	2343948
Cleaning brush	514209

FINISHCONTROL 5000 SPRAYPACK - DPXVLP	2316090
FinishControl 5000, basic unit	-
Air hose including handle, for FinishControl 5000	2314573
StandardSpray spray attachment	2321879

ACCESSORIES	
FineSpray spray attachment	2321877
StandardSpray spray attachment	2321879
WallSpray spray attachment	2321880
Frontend transportation case (Tanos Systemer)	2340218
Can Adapter	2350692

# FINECOAT 9900 PLUS SPRAYPACK



High-performance HVLP paint specialist in an easy-to-use design

- **Compact and easy to use**
- **Permits precise adaptation to the object to be painted and provides an unmistakably fine spray pattern:** even with water-based materials
- **Wide range of applications:** both indoors and outdoors



- **Not suitable for:** use in potentially explosive atmospheres

**Precise adjustment of the spray pattern:** directly on the gun. This way the pattern can be set precisely to the particular object to be coated

**In a single operation:** the air flow rate and the material flow rate can be regulated directly on the gun

**Ergonomic gun build:** The gun fits comfortably in the hand and is effort saving. In addition, the gun is very energy efficient

**Quick-release coupling with integral swivel joint:** for quick connection of the gun to the air hose

**Practical holder:** for the gun. During breaks in work and when transporting, the gun can be safely stored on the unit

**Quick cleaning of the filter:** Take out the filter without tools, just briefly knock out or blow out and refit. Dirty filter warning light indicates if the filter has to be cleaned

**Dual air filtration:** one on the cooling side and another one on the atomizing side with an automotive type air filter with pre filter

**Ultra-powerful:** thanks to the 5-stage turbine



## ACCESSORIES

FineCoat gun, 1-litre pressure cup, incl. nozzle set No. 4	279094
Gravity feed cup, for FineCoat Split Gun, 600 ml	524053
FineCoat Split Gun, suction cup, 1000 ml	524028
Nozzle set, for FineCoat, different sizes	276XXX
Nozzle set, for FineCoat Split Gun	529XXX
Air hose assy. FC-9900 Plus	277236
Hose pack, consisting of material and air hose DN10, 8.2 m	261255
Hose whip, 152 cm, for FineCoat	524405A

## FINECOAT 9900 PLUS SPRAYPACK - DPFC

276048

Air hose assy. FC 9900 Plus

277236

FineCoat gun, 1 litre pressure cup, incl. nozzle set No. 4

277035B

## NOTES

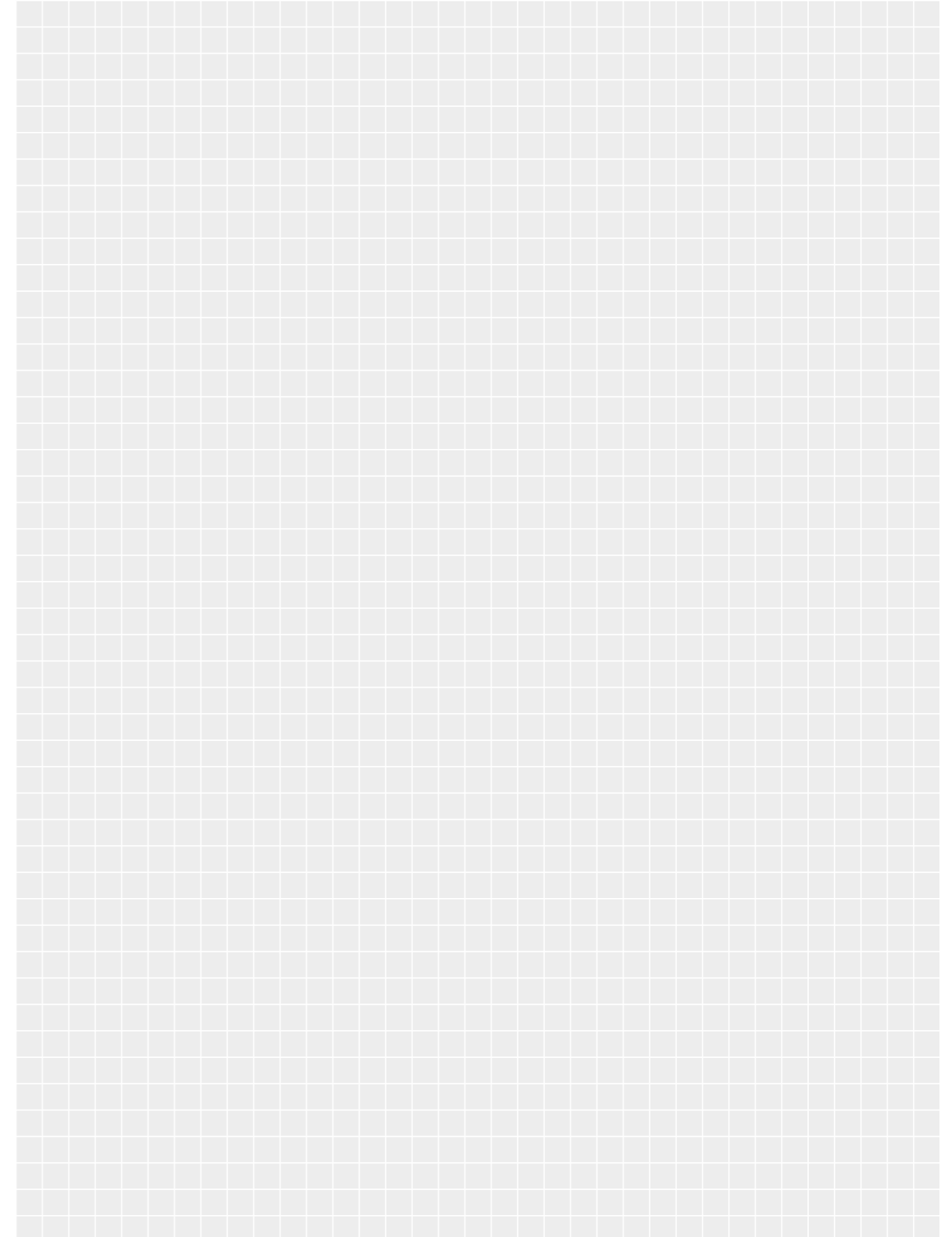



## HEA - HIGH EFFICIENCY AIRLESS

### up to 55% less overspray with maximum control

Do you already value the advantages of airless technology, such as control and comfort? Then you'll be inspired by the new HEA ProTip airless nozzle from WAGNER. It achieves perfect surface results at a much lower spray pressure. Compared to conventional airless technology, the spray edges are softer, the result more even and free from streaks on the edges.

#### More efficiency for prolonged working:

Thanks to the HEA nozzle technology, the spray pressure can be significantly lowered. This reduces the overspray by up to 55 percent. Apart from the much lower masking effort required, this also has a positive effect on the gun's recoil. Working with a WAGNER airless pump is made even easier and more convenient with the HEA technology.

#### 1. MAXIMUM CONTROL:

The gentle spray pattern ensures a more even surface when overlapping the paths and avoids hard edges. This leads to a simple and easy-to-learn technique – even for inexperienced users.

#### 2. PERFECT SURFACE QUALITY:

High Efficiency Airless ensures a uniform and even application on all surfaces and therefore offers excellent surface quality – especially when compared to conventional applications with a brush and roller.

#### Robust and durable:

The nozzle wears more slowly due to the lower spray pressure. This means that HEA nozzles can be used for considerably longer than conventional airless nozzles. Loads on the pump are also reduced due to the lower pressure, with handling of the gun also improved.

#### 3. INCREASED EQUIPMENT LIFESPAN:

Even the lifespan of the spray device itself is prolonged: the lower spraying pressure with High Efficiency Airless means that the system and its components are under less strain.



## DIAPHRAGM PUMP

### Effective material intake – broad range of materials

Do you want to process different materials, from primers to silicate paints with just one device? Then a WAGNER diaphragm pump is the ideal choice. This powerful, maintenance-friendly technology transports the material via a lifting motion of the diaphragm. Diaphragm pumps from WAGNER are robust, easy-to-use construction site and workshop units.

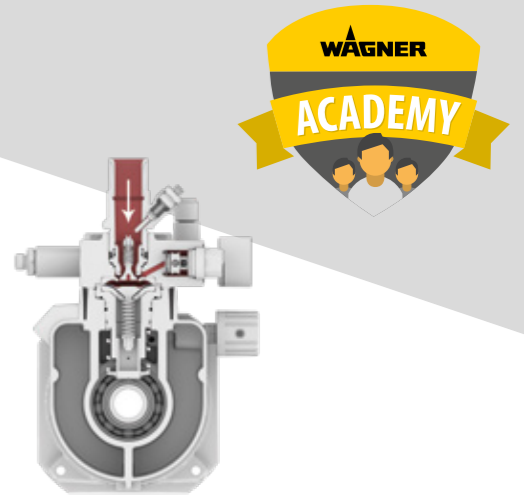

#### The perfect companion for painters and affiliated trades:

The patented Quality-Long-Stroke (QLS) technology from WAGNER, with its optimised hydraulics and special valve technology, means that the material is taken in much more effectively compared to diaphragm pumps from other manufacturers. As a result, a broad range of different materials, such as primers and release agents, primers and lacquers, emulsion and silicate paints, fabric adhesives, corrosion and flame retardants can be processed. In the domain of specially filled materials such as bitumen, fire protection and fillers, piston and spiral pumps are the specialists. Electrically operated diaphragm pumps can be used in both Airless and AirCoat processes with additional air atomization.

#### Fire retardants for joiners, metalworkers and similar trades :

Pneumatic double diaphragm pumps are ideal for the wood and metal processing industry. In this case, the material is transported via the lifting motion of two opposing diaphragm which generates a lower-pulsation material flow. This allows you to work with materials which are particularly sensitive to shearing and moisture and with premixed two-component materials. WAGNER double diaphragm pumps are explosion-proof and operated by compressed air, which means that they can be used safely in workshops and in painting booths.

#### 1. ALSO SUITABLE FOR VERY SMALL VOLUMES:

Diaphragm pumps have up to 58 per cent\* less material in their system. The device's small cross-sections means that it can also be operated with tiny amounts of material. This saves resources both when changing material and during the cleaning process.

#### 2. LOW-MAINTENANCE AND DURABLE:

The reduced lifting frequency of the diaphragm means that the already lower number of wear parts are placed under significantly less stress. This significantly reduces maintenance costs\*. However, should a repair be necessary, the corresponding components can be easily replaced directly on site and in the case of both valves for example, within minutes.

#### 3. FINE AND EVEN SPRAY PATTERN:

Diaphragm technology reduces the pulsation of the material flow, which avoids any irregularities in the spray pattern. It remains fine and even. The piston's switching point is also dispensed with in a diaphragm pump.

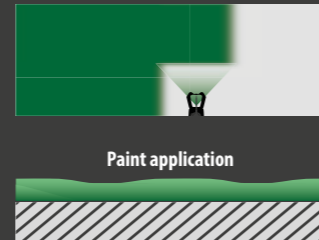

Standard airless technology

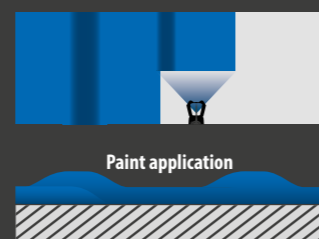
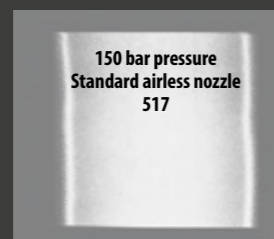

## SPRAYPATTERN AT LOW PRESSURE



irregular spray pattern from the piston pump



even spray pattern from the diaphragm pump

## BENEFITS

- Large range of material
- Flexible material intake
- Fully adjustable pressure regulation from 0 - 25 MPa
- QLS technology with longer stroke
- Low-pulsation
- Robust and very low-maintenance
- Simple maintenance
- Low noise

\*Compared to other airless nozzles on the market

\*Compared to other piston pumps on the market

# SUPERFINISH 23 PRO HEA SPRAYPACK



For perfect results with maximum control thanks to innovative airless diaphragm technology

- **Innovative HEA technology:** Up to 55 % less overspray with maximum control.
- **Flexible suction hose:** The diaphragm pump draws materials such as emulsions, latex paints or lacquers directly from the original container.
- **For small emulsion jobs**
- **Easy to move:** The SuperFinish 23 Pro, with its foldable

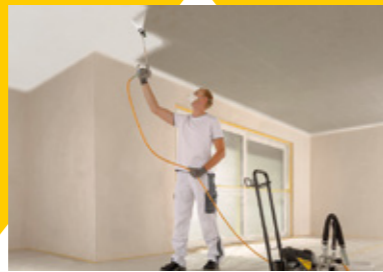

- frame, is ideal for easy and space-saving transport on the construction site.
- **SuperFinish 23 Pro is virtually maintenance-free:** works reliably and durably and can be used with even small amounts of material.

**Superb Spray Surface Quality:** with the Vector Pro Airless gun. Light in weight with a long service life

**Flexible Suction Hose for direct suction from the container:** Trouble free working thanks to the special fine mesh suction intake filter

**HEA Pressure Gauge:** allows monitoring of the spray device pressure. HEA nozzles allow work in the low-pressure range (ideally at 80 - 140 bar) that is marked with green on the pressure gauge

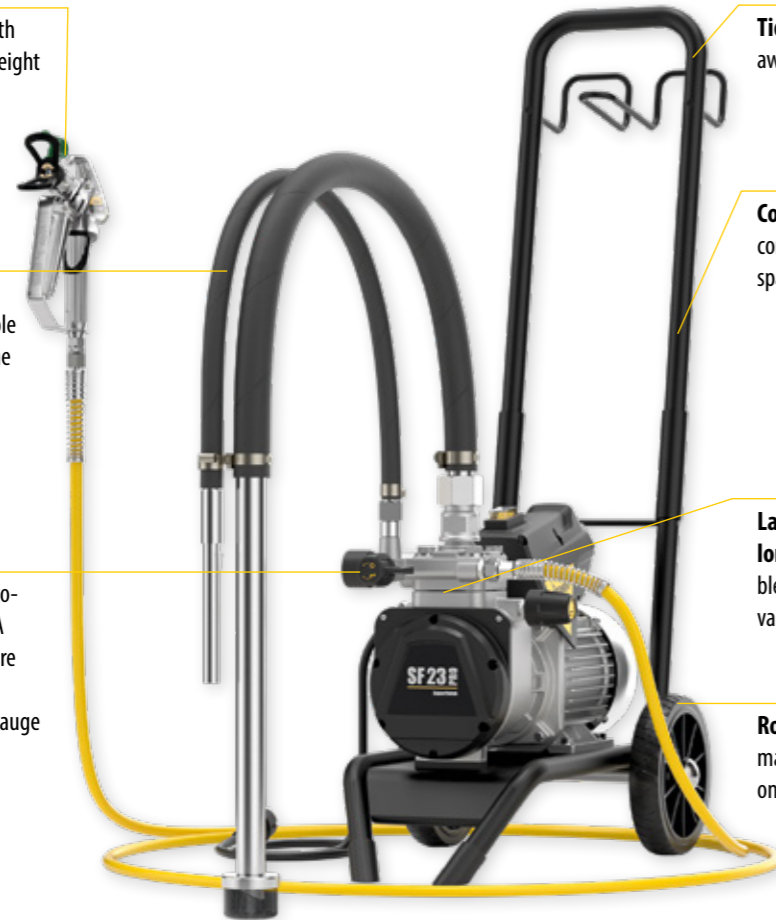

**Tidy:** Hoses can be practically stowed away thanks to the integrated rack

**Convenience:** The foldable frame allows convenient building site transport and space saving storage

**Large variety of materials with QLS long-stroke technology:** Made possible by optimised hydraulics and special valve technology

**Robust design:** with heavy duty tyres making the SF 23 Pro the perfect partner on every construction site

**HEA** HIGH EFFICIENCY AIRLESS

≤ 0.023"; 2.6 l/min

## SUPERFINISH 23 PRO HEA SPRAYPACK - DPFSF 2399198

Basic unit, SF 23 Pro, cart version	-
HP hose DN6, 25 MPa, NPSM 1/4", 15m	2390608
Suction hose assy. (return hose and filter included)	2393123
Airless Vector Pro gun, 1/4", incl. TradeTip 3 nozzle holder, with 4-finger trigger	538040
HEA ProTip, 519	554519
HEA pressure gauge set assy	252475
Tool bag, incl. wrench 41mm/22mm/19mm and screw driver	2390620

## ACCESSORIES

HEA ProTip, different sizes (e.g. tip 211 - Art.No. 517211)	554XXX
5 litre hopper, M36x2	341265
Nozzle extension, 30 cm, G-thread	556075
Nozzle extension, 60 cm, G-thread	556077
Hydraulic oil Divinol 1 litre	21061
TipClean; 200ml	2400214

## PRACTICAL ACCESSORIES SF 23 PRO

### AIRLESS GUNS

Vector Pro, 1/4", incl. TradeTip 3 nozzle holder, with 2-finger trigger	538041
Vector Pro, 1/4", incl. TradeTip 3 nozzle holder, with 4-finger trigger	538040
Vector Grip, 1/4", incl. TradeTip 3 nozzle holder, with 2- and 4-finger trigger	538043

### AIRLESS HOSE

HP hose DN3, max. 27 MPa, NPS 1/4", 7.5 m	9984583
-------------------------------------------	---------

### AIRCOAT ACCESSORIES

AirCoat gun AC 4500, incl. blue air cap and holder	2368269
HP double hose, material DN3, max. 27 MPa, air DN6, 1/4", 7.5 m	9984595
AirCoat regulator, fitting kit	340250

### OTHERS

5 litre hopper, M36x2	341265
Pressure gauge set assy. HEA(MPa)	2383995
Nozzles HEA ProTip, different sizes	554XXX
Nozzles TradeTip 3, different sizes	553XXX

## RECOMMENDED USE

### MATERIALS:

Water and solvent-based lacquers, lacquer paints, oils, separating agents	Synthetic resin lacquers, PVC lacquers, 2K lacquers
Primers, fillers	Fire protection, rust protection paints
Emulsion and latex paints, adhesives, sealants	Exterior paints, roof coatings, floor coatings, textured paint

### OBJECT SIZE:

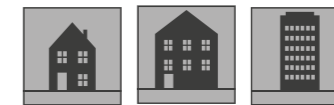

For different project sizes

## TECHNICAL DATA

Motor output	1.3 kW
Voltage	230 V / 50 Hz
Max. operating pressure	250 bar, 25 MPa
Max. delivery rate	2.6 l/min
Weight	27 kg
Max. nozzle size	0.023"
Max. viscosity	20.000 mPas

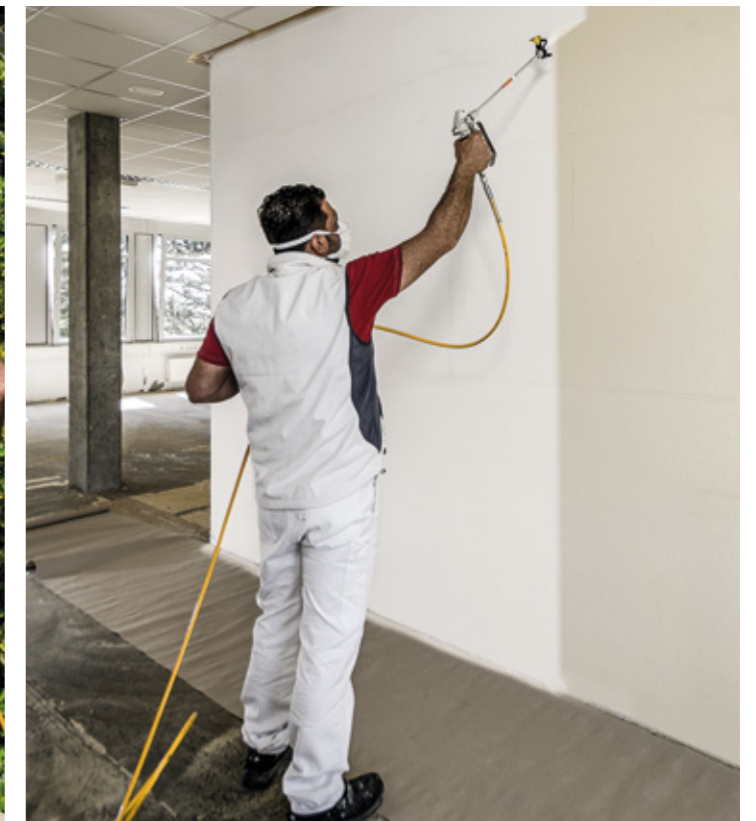

# SUPERFINISH 23 PLUS HEA SPRAYPACK



Compact – light and yet robust

- **Innovative, low-pressure airless technology:** up to 55 % less overspray
- **Compact:** Smallest in its class, mobile and light
- **For medium-sized emulsion jobs**
- **Robust:** Ideal for demanding construction site use
- **PumpRunner:** Perfect for clean, tidy transport



- **Use with 20 m hoses guaranteed with any material**

# SUPERFINISH 23 PLUS AIRLESS ENAMEL SPRAYPACK



The perfect solution for small paint jobs using diaphragm technology

- **Entry-level Airless spraypack**
- **Straightforward handling and simple operation:** Multifunction switch for greater safety - It is impossible to turn the unit on and off under pressure
- **Improved performance:** No-maintenance brushless motor



- **FineFinish painting:** with hopper and the special FineFinish nozzle

**Large variety of materials with QLS long-stroke technology:** The optimised hydraulics and special valve technology make it possible

**Multifunction switch for extra safety:** on/off as well as circulation and spray mode. This prevents accidental switching on or off while the system is under pressure



**Superb Spray Surface Quality:** with the Vector Grip Airless gun. Light in weight with a long service life

**Infinitely variable pressure regulation:** from 0 to 250 bar

**Direct suction:** straight from the container for trouble-free working. Inclusive PumpRunner for clean transport included

**HEA** HIGH EFFICIENCY AIRLESS

≤ 0.023"; 2.6 l/min

## SUPERFINISH 23 PLUS HEA SPRAYPACK - DPFSE 2384153

Basic unit, SF 23 Plus, cart version	-
Suction system complete, for SF 23 Plus, incl. PumpRunner	2342879
HP hose DN6, 27 MPa, NPSM 1/4", 15 m	9984574
Pressure gauge set assy. HEA (MPa)	2383995
Airless gun Vector Grip, 1/4", incl. TradeTip 3 nozzle holder, with 2- and 4-finger trigger	538043
HEA ProTip 519	554519
Gun filter white, 1 piece, 50 MA, 0.31 mm MW, medium	34377

### ACCESSORIES

HEA ProTip, different sizes (e.g. tip 211 - Art.No. 517211)	554XXX
5 litre hopper, M36x2	341265
Nozzle extension, 30 cm, G-thread	556075
Nozzle extension, 60 cm, G-thread	556077
Hydraulic oil Divinol 1 litre	21061
TipClean; 200ml	2400214

**Large variety of materials with QLS long-stroke technology:** The optimised hydraulics and special valve technology make it possible

**Infinitely variable pressure regulation:** from 0 to 250 bar

**Multifunction switch for extra safety:** on/off as well as circulation and spray mode. This prevents accidental switching on or off while the system is under pressure

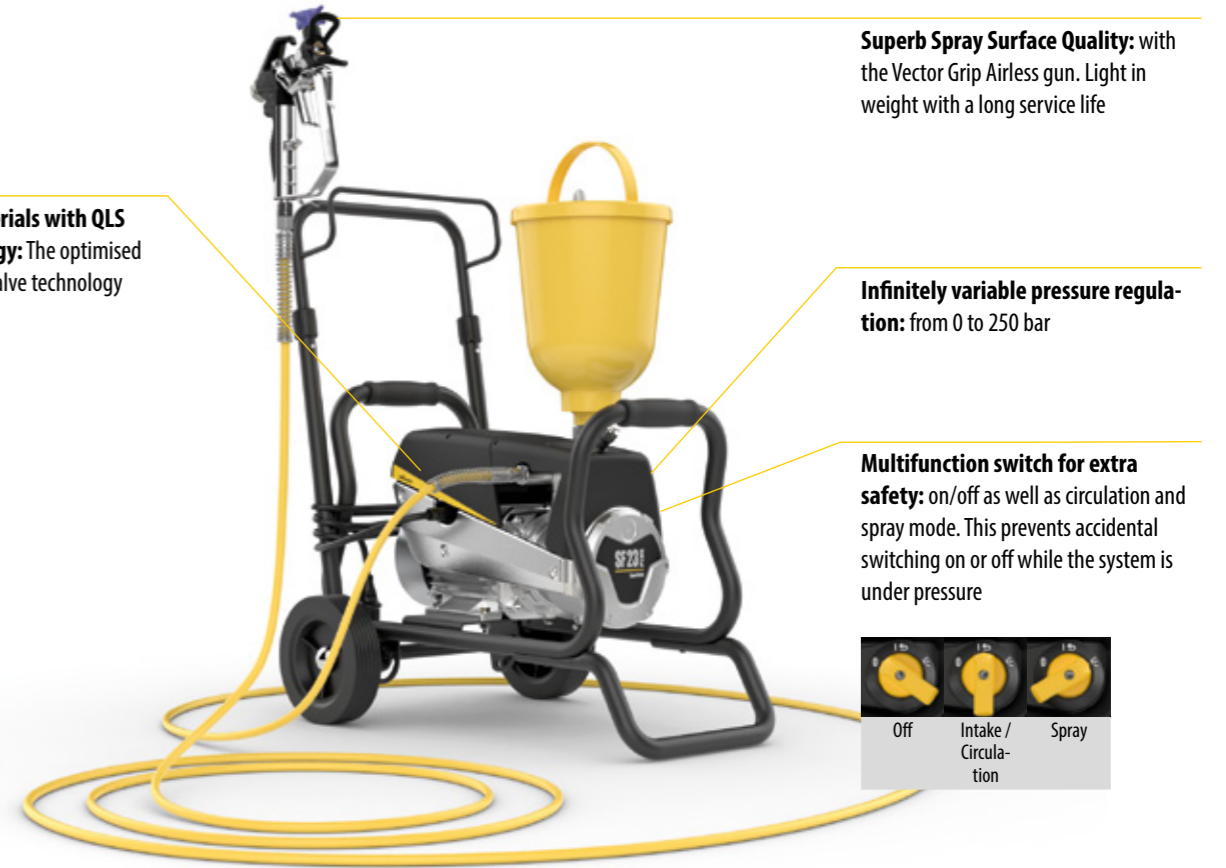

**Superb Spray Surface Quality:** with the Vector Grip Airless gun. Light in weight with a long service life

≤ 0.023"; 2.6 l/min

## SUPERFINISH 23 PLUS AIRLESS ENAMEL - CART VERSION DPFSE 2341492

Basic unit, SF 23 Plus on cart	-
5 litre hopper, M36x2	341265
HP hose DN3, 27 MPa, NPS 1/4", 7.5 m	9984583
Airless gun Vector Grip, 1/4", incl. TradeTip 3 nozzle holder, with 2-finger trigger	538042
2SpeedTip, L10, 208 / 510	271042
Gun filter red, 1 piece, 180 MA, 0.084 mm MW, extra fine	34383

### ACCESSORIES

TradeTip 3 FineFinish nozzles, different sizes (e.g. tip 210 - Art. No. 517210)	554XXX
2SpeedTip, different sizes	271XXX
5 litre hopper, M36x2	341265
Nozzle extension, 30 cm, G-thread	556075
Nozzle extension, 60 cm, G-thread	556077
Hydraulic oil Divinol 1 litre	21061
TipClean; 200ml	2400214



# SUPERFINISH 23 PLUS TEMPSPRAY SPRAYPACK



## Enamel specialist with heated hose

- **Perfect surface results:** thanks to heated hose
- **Also ideal for:** highly viscous materials such as enamels with high VOC content
- **The TempSpray system heats the material directly in the hose:** thereby ensuring perfect viscosity without the need for thinning, as well as optimum paint application



**Perfect surface quality with Temp-Spray:** Thanks to warming up the coating material a very soft spray pattern is generated. This increases the atomisation quality. Further advantages are: reduced overspray, perfect viscosity without diluting and much more

**Large variety of materials with QLS long-stroke technology:** The optimised hydraulics and special valve technology make it possible

**Superb Spray Surface Quality:** with the Vector Grip Airless gun. Light in weight with a long service life

**Infinitely variable pressure regulation:** from 0 to 250 bar

**Multifunction switch for extra safety:** on/off as well as circulation and spray mode. This prevents accidental switching on or off while the system is under pressure



**T** ≤ 0.023"; **Y** 2.6 l/min

### SUPERFINISH 23 PLUS TEMPSPRAY SPRAYPACK - DPFSF 2341496

Basic unit, SF 23 Plus on cart	-
5 litre hopper, M36x2	341265
TempSpray H 126 basic unit, 10 m	2311659
Airless gun Vector Grip, 1/4", incl. TradeTip 3 nozzle holder, with 2- and 4-finger trigger	538043
2SpeedTip, L10, 208 / 510	271042
Gun filter red, 1 piece, 180 MA, 0.084 mm MW, extra fine	34383

### ACCESSORIES

TradeTip 3 FineFinish nozzles, different sizes (e.g. tip 210 - Art. No. 517210)	554XXX
2SpeedTip, different sizes	271XXX
5 litre hopper, M36x2	341265
Nozzle extension, 30 cm, G-thread	556075
Nozzle extension, 60 cm, G-thread	556077
Hydraulic oil Divinol 1 litre	21061
TipClean; 200ml	2400214

# SUPERFINISH 23 PLUS AIRCOAT ENAMEL SPRAYPACK



## Mobile complete solution for enamel work

- **With AirCoat technology:** Particularly fine atomisation for a perfect finish
- **Perfectly matching components:** Minimal overspray and high application efficiency
- **Particularly easy handling**
- **The industry standard:** quality-crafted by WAGNER



- **Suitable for:** non EX environments

**Large variety of materials with QLS long-stroke technology:** The optimised hydraulics and special valve technology make it possible

**Ergonomic AirCoat gun AC 4600:** The low air consumption and the soft spray pattern guarantee perfect painting results

**Infinitely variable pressure regulation:** from 0 to 250 bar

**Multifunction switch for extra safety:** on/off as well as circulation and spray mode. This prevents accidental switching on or off while the system is under pressure

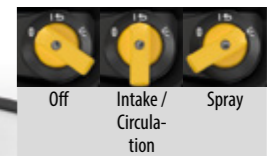

With AirBoost 100 compressor

**T** ≤ 0.023"; **Y** 2.6 l/min

### SUPERFINISH 23 PLUS AIRCOAT ENAMEL SPRAYPACK - DPFSF 2353393

Basic unit, SF 23 Plus on cart	-
5 litre hopper, M36x2	341265
HP double hose, material DN4, max. 27 MPa, air DN6, 1/4", 10 m	2302379
AirCoat gun AC4600 Professional Pro Box	394155
Nozzle ACF3000 11/40	379411
Green air cap	394912
AirBoost 100 compressor	2347935
AirCoat regulator, fitting kit	340250

### ACCESSORIES

Compressor AirBoost 100	2347935
AirCoat nozzle ACF 3000, different sizes	379XXX
Blue air cap, incl. union nut	394911
Green air cap, incl. union nut	394912
Red air cap, incl. union nut	394910
Union nut complete	394921
Gun filter, yellow, fine, set of 10 pieces,	97023
Gun filter, red, extra fine, set of 10 pieces	97022

# SUPERFINISH 23 CR



## Professional injection and crack repair

- **Powerful:** big diaphragm surface for perfect usage with high viscosity materials and a long life time
- **Variety of materials:** suitable for Epoxy and Polyurethanes (PU), SPUR foam, aqueous solutions
- **Simple:** service, cleaning and maintenance directly on the job site is no problem at all



- **Ease of use:** handy pressure regulation in low pressure areas
- **Durable:** All wetted parts out of stainless steel

# SUPERFINISH 33 PRO SPRAYPACK



## One diaphragm pump for every project – outstanding performance for indoor and outdoor application

- **Versatile applications:** The SuperFinish 33 Pro can process a diverse range of materials and service a wide variety of industries and project sizes.
- **Optimum efficiency and productivity:** With a delivery rate of 4.3 litres per minute, the SuperFinish 33 Pro is the most powerful WAGNER diaphragm pump in the professional segment.



- **Quality LongStroke Technology (QLS):** For a long service life, easy maintenance and low wear.
- **Practical multi-gun operation:** For parallel use, a distributor adapter for connecting up to three airless guns is available separately as an accessory.

**Easy to clean:** 5 liters hopper for fast material changes and small quantity processing. Hopper and various suction systems as accessories available.

**Pressure relief directly at the unit:** stainless steel ball valve - especially for injection application

**Versatile:** Easy to use with all commercially available injection packers



**Easy to transport:** Robust cart with height-adjustable handle

**Inlet pusher valve:** for a high operating reliability and easy commissioning. Just the press of a finger, and the valve is free

**Brushless motor:** maintenance free and completely reliable

**Fine adjustment:** Smooth pressure regulation from 0-250 bar for all applications.

### ACCESSORIES

Airless Pistole AG 14; G-Gewinde 1/4"; inkl. TradeTip 3 Düsenhalter	0502081A
HP hose DN6, 27 MPa, NPSM 1/4", 15m	9984574
Hose whip with mouthpiece	97057
Seal for nozzle installation	43052
5 liter hopper, M36x2	341265
Suction system flexibel	2393123
Suction system rigid	2405950



2.6 l/min

### SUPERFINISH 23 CR

Basic unit; SF 23 CR on cart	-
Pressure gauge combination HEA (MPa)	2383995

### SUPERFINISH 23 CR - DPFSF 2415601

No Spraypack



**Ergonomic work:** With the Airless gun Vector Pro. It is light and robust

**Easy to transport:** Robust cart with height-adjustable handle

**Inlet pusher valve:** for a high operating reliability and easy commissioning. Just the press of a finger, and the valve is free

**Large variety of materials with QLS long-stroke technology:** The optimised hydraulics and special valve technology make it possible

**Robust, building-site-friendly tires:** allow easy transport across even the most challenging terrain

≤ 0.033"; 4.2 l/min

### SUPERFINISH 33 PRO SPRAYPACK - DPFSF 2388 260

SuperFinish 33 Pro, basic unit	-
Suction system, flexible	34630
HP hose, DN6, PN270, NPSM 1/4", 15m	9984574
Airless gun Vector Pro, 1/4", incl. TradeTip 3 nozzle holder, with 4-finger trigger	0538040
TradeTip3 nozzle 523 incl. white filter	553523

### ACCESSORIES

TradeTip 3 FineFinish nozzles, different sizes (e.g. tip 211 - Art. No. 517211)	554XXX
TradeTip 3 FineFinish nozzles, different sizes	554XXX
Nozzles TradeTip 3, different sizes	553XXX
Nozzles 2SpeedTip, different sizes	271XXX
5 litre hopper, M36x2	341265
Nozzle extension, 30 cm, G-thread	556075
Nozzle extension, 60 cm, G-thread	556077
Hydraulic oil Divinol 1 litre	21061
TipClean; 200ml	2400214



# SUPERFINISH 33 PLUS SPRAYPACK



The extremely easy-to-use diaphragm pump for every project

- **Versatile applications:** The SuperFinish 33 Plus can process a diverse range of materials and service a wide variety of industries and project sizes.
- **Optimum efficiency and productivity:** With a delivery rate of 4.3 litres per minute, the SuperFinish 33 Plus is the most powerful WAGNER diaphragm pump in the professional segment.

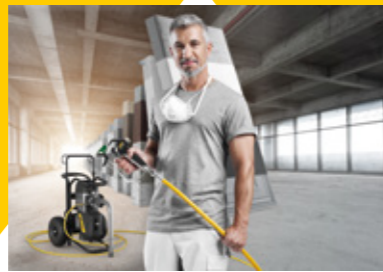

- **Practical multi-gun operation:** For parallel use, a distributor adapter for connecting up to three airless guns is available separately as an accessory.
- **Flexible use:** Switch the pump position with a single hand movement from working with the top container to the rigid suction system with fine filter meshes.

**Ergonomic working:** with the high quality Vector Grip Airless gun. It is light, robust and highly ergonomic

**Modular variants:** two-position cart for use with the top container or rigid suction system



**Includes a handy 230 V socket :** to connect additional devices, such as TempSpray

**Inlet pusher valve:** for a high operating reliability and easy commissioning. Just the press of a finger, and the valve is free

**Illuminated multifunction switch for extra safety:** on/off as well as circulation and spray mode. This prevents accidental switching on or off while the system is under pressure

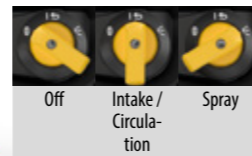

**Robust, building-site-friendly tires:** allow easy transport across even the most challenging terrain

**Integrated toolbox:** including a handy organiser to ensure the right tools and accessories are always at hand



**Direct suction:** straight from the container for trouble-free working – thanks to the special filter with ultra-fine filter mesh

≤ 0.033"; 4.2 l/min

**SUPERFINISH 33 PLUS SPRAYPACK - DPFSF 2388259**

SuperFinish 33 Plus, basic unit	-
Suction system, rigid, D38	2370310
HP hose DN6, max. 27 MPa, NPSM 1/4", 15 m	9984574
Airless gun Vector Grip, 1/4", incl. TradeTip 3 nozzle holder, with 2- and 4-finger trigger	0538043
2SpeedTip nozzle D20 115/421	0271046

## ACCESSORIES

TradeTip 3 FineFinish nozzles, different sizes (e.g. tip 211 - Art. No. 517211)	554XXX
Nozzles 2SpeedTip, different sizes	271XXX
5 litre hopper, M36x2	341265
Nozzle extension, 30 cm, G-thread	556075
Nozzle extension, 60 cm, G-thread	556077
Hydraulic oil Divinol 1 litre	21061
Adapter for multi-gun operation (up to 3 guns)	2304430

## HANDY ACCESSORIES SF 33 PLUS

### AIRLESS GUNS

Vector Pro, 1/4", incl. TradeTip 3 nozzle holder, with 4-finger trigger	538040
Vector Pro, 1/4", incl. TradeTip 3 nozzle holder, with 2-finger trigger	538041
Vector Grip, 1/4", incl. TradeTip 3 nozzle holder, with 2- and 4-finger trigger	538043
Vector Infinity, G-thread 1/4", incl. TradeTip 3 nozzle holder, with 2-finger trigger	538085
AG 14, G-thread 1/4", incl. TradeTip 3 nozzle holder	0502081A

### AIRLESS HOSES

HP hose DN3, max. 27 MPa, NPS 1/4", 7,5 m	9984583
HP hose DN6, max. 27 MPa, NPS 1/4", 15 m	9984574
HP hose DN6, max. 27 MPa, NPS 1/4", 30 m	9984575
HP hose DN10, max. 25 MPa, 3/8" NPSM, 15 m	2336583

### AIRLESS NOZZLES

2SpeedTip nozzles, different sizes	271XXX
TradeTip 3 nozzles, different sizes	553XXX
HEA ProTip nozzles, different sizes	554XXX

### GUN FILTERS

Gun filter red, 10 pieces, 180 MA, 0.084 mm MW, extra fine	97023
Gun filter yellow, 10 pieces, 100 MA, 0.14 mm MW, fine	97022
Gun filter white, 10 pieces, 50 MA, 0.31 mm MW, medium	97024

### AIRCOAT ACCESSORIES

AirCoat gun AC 4500, incl. blue air cap and holder	2368269
HP double hose, material DN3, max. 27 MPa, air DN6, 1/4", 7.5 m	9984595
AirCoat regulator, fitting kit	340250
AirCoat nozzles ACF3000 (different sizes)	379XXX

### OTHER

InlineRoller packaged in a plastic box, incl. HP hose DN4, 27 MPa, 7.5 m, extension complete 0.5 m, woven plush paint roller short pile 13 mm, and so on	345010
Adapter for multi-gun operation (up to 3 guns)	2304430
Double connector A = 1/4" x 1/4"	34038
Coupling sleeve I = 1/4" NPSM x A = 3/8" NPSM, 27 MPa	179732
Hopper set, 5 litre, M36x2	341265
PumpRunner	2306987
Nozzle extension, 15 cm, G-thread	556074
Hose reel HR30, M16x1.5 (without hose)	2392523

## RECOMMENDED USE

### MATERIALS:

Water and solvent-based lacquers, lacquer paints, oils, separating agents	Synthetic resin lacquers, PVC lacquers, 2K lacquers
Primers, fillers	Fire protection, rust protection paints
Emulsion and latex paints, adhesives, sealants	Exterior paints, roof coatings, floor coatings

### OBJECT SIZE:



For different project sizes

## TECHNICAL DATA

Motor output	2.2 kW
Voltage	230 V / 50 Hz
Max. operating pressure	250 bar, 25 MPa
Max. delivery rate	4.2 l/min
Delivery rate at 12 MPa spray pressure	3.8 l/min
Max. nozzle size	0.033"
Weight	50 kg



### CONNECTION OF UP TO THREE GUNS

This way you work even 3 times faster! The accessory is sold separately (Secound gun kit art. no. 2413598).

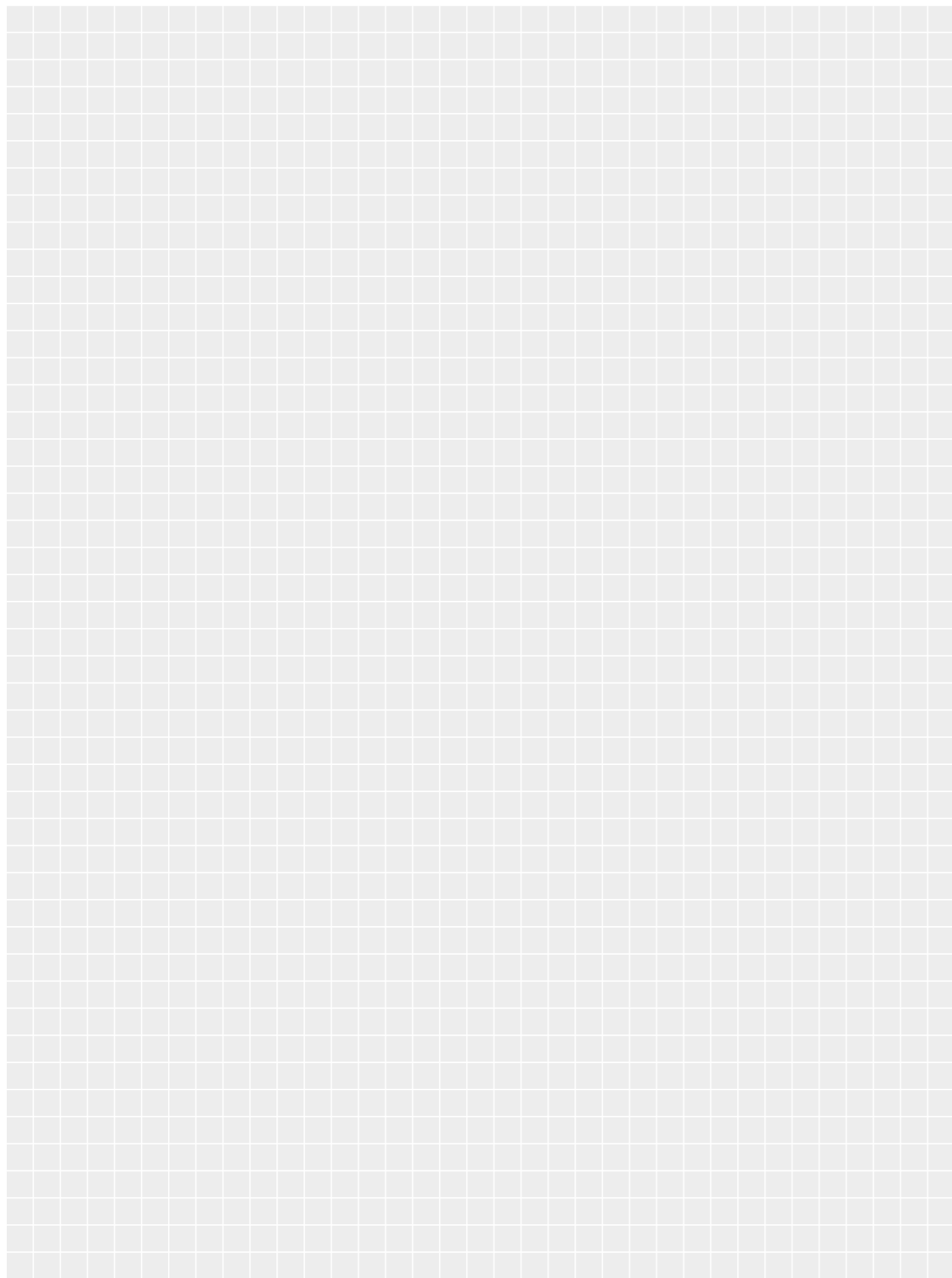

## ELECTRIC PISTON PUMP

### Especially high suction and delivery performance – across the range

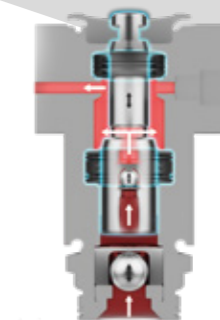

Do you mostly work with viscose or filler materials? Then an electric WAGNER piston pump is the the best support for you. The high suction power produced by the piston's lifting motion makes it ideal for this type of material.

**Various performance classes for professional and semi-professional users:**

With the third generation of piston pumps from WAGNER, you have a choice of machines for large or small sites. They cover a broad range of paints and emulsions - right through to high-viscosity and filler materials for interior and exterior use.

**A powerful companion - inside and out:**

WAGNER piston pumps are available with three different drive systems. Electric piston pumps cover a wide range of performance classes and have a compact design. The hydraulic piston pumps offer even better performance and are available with a choice of either petrol or electric motors which can be switched in a few minutes. Pneumatically driven piston pumps from WAGNER are explosion-proof and therefore are suitable for use in workshops.

**1. BRUSHLESS MOTOR:**

Brushless motors are a real benefit for this device, especially in terms of its long service life. Alongside its efficient mode of working, its key advantages include a constantly high torque with low power consumption and reduced heat generation.

**2. NO CONTINUOUS RUNNING:**

Piston pumps only operate when you have to build up pressure. The rest of the time, the drive is on 'standby'. This protects wear parts and has a positive impact on site noise levels.

### CROSS-SECTION OF THE PISTON

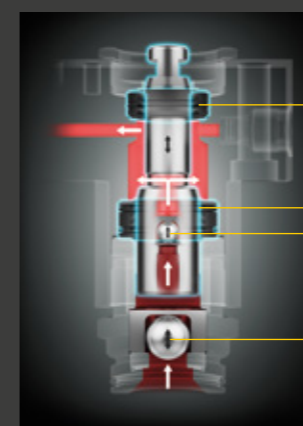

upper packing  
lower packing inlet-valve  
outlet-valve

### ADVANTAGES

- Powerful suction
- Better delivery capacity with high viscosity materials
- Less sensitive to filled materials
- Large nozzle sizes can be used
- Extra-durable packing

# POWERPAINTER 90 EXTRA SPRAYPACK



Fast, clean, perfect – the airless paint spraying system for small projects

- **Innovative, high-efficiency airless technology (HEA):** The HEA ProTip nozzle ensures up to 55 % less overspray, as well as a longer service life thanks to reduced spray pressure.
- **Easy painting:** Noticeably easier paint application thanks to a soft spraying pattern with maximum control.

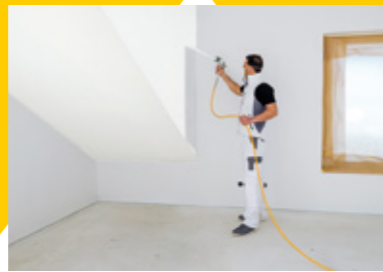

- **Direct suction from the original container:** The airless paint spraying system extracts materials directly out of the paint bucket or varnish container.

**Comfortable:** The variably adjustable telescopic handle allows a convenient transport on the construction site and a space-saving storage of the device

**Pressure gauge:** Allows the perfect control of pressure in coordination with the material being processed

**DN 6, 15 m high-pressure hose:** for a large radius of action.

**Integrated storage box:** Ideal for storing tools and accessories



**Innovative HEA nozzle technology:** two nozzle orifices, one directly in front of the other, guarantee a perfect spray pattern with high material throughput even in low pressure ranges

**Lightweight airless gun with four-finger trigger:** for fatigue-free and safe work

**Double-Acting-piston pump:** for consistent material feed

**Inlet pusher valve:** for a high operating reliability and easy commissioning. Just the press of a finger, and the valve is free

Also available as skid-version



**HEA** HIGH EFFICIENCY AIRLESS

≤ 0.019"; 1.6 l/min

## POWERPAINTER 90 EXTRA SPRAYPACK

Basic unit, PowerPainter 90 Extra	-
Airless gun Vector Pro, 1/4", incl. TradeTip 3 nozzle holder, with 4-finger trigger	538040
HP hose DN6, 15 m	523699
Pressure gauge (HEA)	2383995
HEA ProTip 517	554517
EasyGlide, special oil, 118 ml	508619

**PP 90 EXTRA SPRAYPACK - CART VERSION - DPPPE** 2401275

**PP 90 EXTRA SPRAYPACK - SKID VERSION - DPPPE** 2414079

## ACCESSORIES

Airless Vector Grip gun, 1/4", incl. TradeTip 3 nozzle holder, with 2- and 4-finger trigger	538043
TradeTip 3 FineFinish nozzles, different sizes	554XXX
Nozzle extension, 15 cm, G-thread	556074
Nozzle extension, 30 cm, G-thread	556075
EasyGlide, special oil, 118 ml	508619
TipClean; 200ml	2400214

# PROSPRAY 3.20 HEA SPRAYPACK



The compatible piston pump for Airless beginners

- **Robust and simple:** perfect for use on the construction locations, reliable, easily accessible high quality packings
- **Good performance at an attractive price:** for medium-sized projects, ideal for interior emulsion paints
- **Innovative, low-pressure airless technology:** up to 55 % less overspray due to HEA technology



- **With flexible suction system:** for simple intake directly from the original container
- **Well-proven piston pump:** ideal for comfortable transport and space-saving storage



**Included:** tool bag with two open-end spanners

**HEA pressure gauge:** a longer service life thanks to innovative HEA low-pressure airless technology

**Inlet pusher valve:** for a high operating reliability and easy commissioning. Just the press of a finger, and the valve is free

**User-friendly:** easy to operate and a reduced number of settings options makes starting up the sprayer easier.

**HEA 517 nozzle:** for a soft spray pattern and up to 55 % less spray mist



**Hose rewind:** for optimised storage of the hose

**Double-Acting-piston pump:** for consistent material feed

**HEA** HIGH EFFICIENCY AIRLESS

≤ 0.021"; 1.6 l/min

## PROSPRAY 3.20 HEA SPRAYPACK

ProSpray 3.20 basic unit	-
HP hose DN6, 27 MPa, NPSM 1/4", 15 m	9984574
Flexible suction system	0558672
Pressure gauge set assy. HEA(MPa)	2383995
Airless Vector Pro gun; 1/4"; incl. TradeTip 3 nozzle holder; with 4-finger trigger	538040
HEA ProTip 517	554517

**PROSPRAY 3.20 HEA SPRAYPACK - DPPS** 2412438

## ACCESSORIES

Nozzle extension, 15 cm, G-thread	556074
Nozzle extension, 30 cm, G-thread	556075
5 litre hopper	704-453
HEA ProTip various sizes (e.g. 211 – Art-No 554211)	554XXX
TradeTip3 Fine Finish various sizes	554XXX
TipClean 200 ml	2400214
HP hose DN4, 27 MPa, NPS 1/4", 7.5 m	9984573
Lack Kit (DN 4) for ProSpray pumps	2406206

# PROSPRAY 20 HEA SPRAYPACK



The robust piston pump for Airless beginners

- **Built tough:** for a long service life on the construction site
- **Compact and simple design**
- **Easy handling:** thanks to HEA technology
- **Optimised lifetime and performance**



- **Innovative ProSpray product features:** for example new packings

# PROSPRAY 3.21 HEA SPRAYPACK



Small and compact – for small object sizes

- **Innovative, low-pressure airless technology:** up to 55 % less overspray
- **Optimum value-for-money:** Ideal for all users who mostly spray-coat small surfaces on a daily basis
- **For trouble-free operation:** Integrated high-pressure filter



- **Compact design with outstanding performance data:** 0.023" nozzle size, 2.0 l/min max., delivery rate: 16 kg weight
- **With flexible suction system:** for simple intake directly from the original container

**Compact:** for easy transportation and space-saving storage

**HEA Pressure Gauge:** longer life thanks to innovative HEA low-pressure airless technology

**Practical cable wrap:** for tidy storage of the electric cable

**HEA 517 nozzle:** soft spray pattern and up to 55% less overspray

**DN6, 15 m high-pressure hose:** for a large radius of action

**Drip cup:** possible residues in the suction hose can be captured during transport

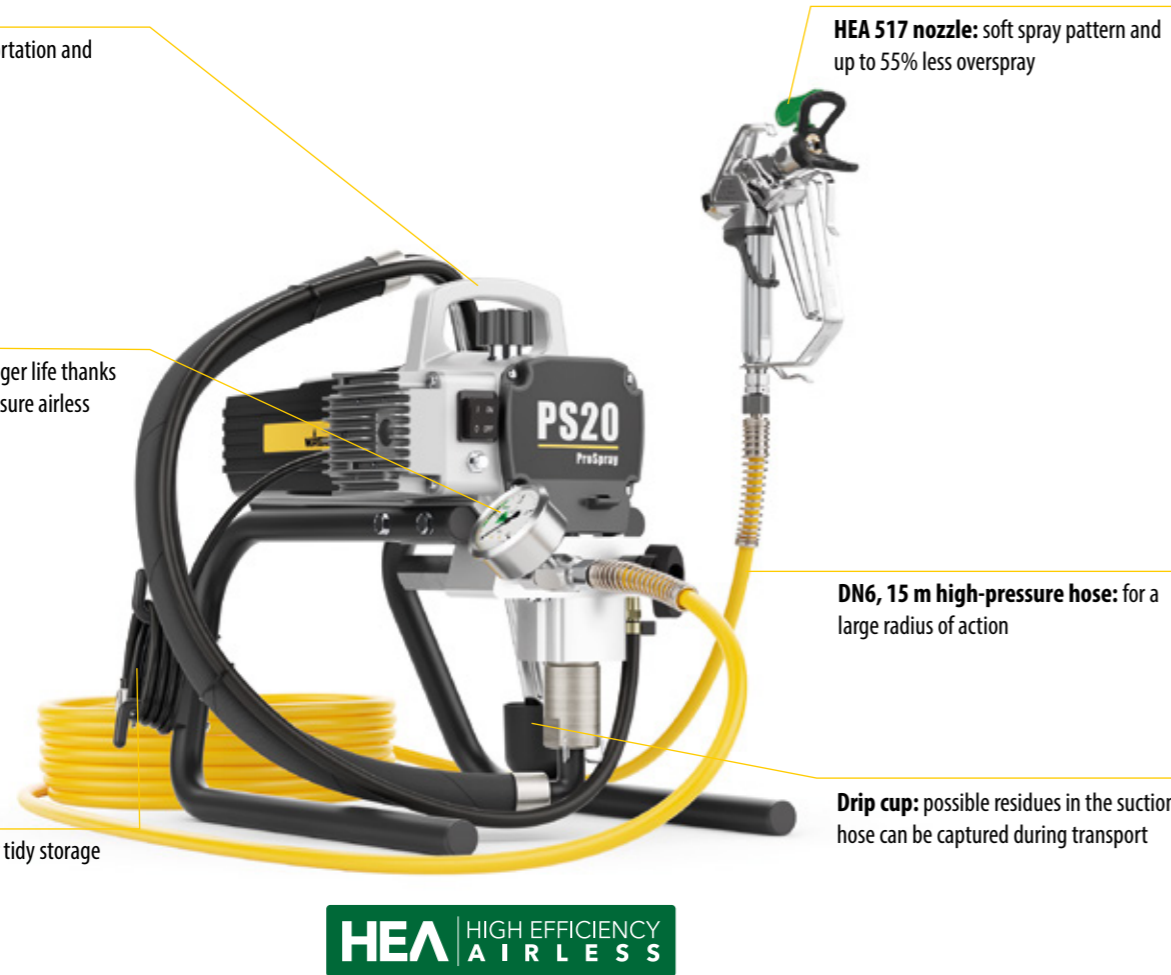

**HEA** HIGH EFFICIENCY AIRLESS

**Compact:** for easy transportation and space-saving storage

**Maintenance made easy:** With the push of a button the piston is oiled and thus the packings are conserved.

**HEA Pressure Gauge:** longer life thanks to innovative HEA low-pressure airless technology

**HEA 517 Tip:** soft spray pattern and up to 55% less overspray

**DN6, 15 m high-pressure hose:** for a large radius of action

**Inlet pusher valve:** for a high operating reliability and easy commissioning. Just the press of a finger, and the valve is free.



**HEA** HIGH EFFICIENCY AIRLESS

**T** ≤ 0.021"; **Y** 1.6 l/min

## PROSPRAY 20 HEA SPRAYPACK - DPPS 2403616

ProSpray 20, basic unit	-
HP hose DN6, 27 MPa, NPSM 1/4", 15 m	9984574
Flexible suction system	0558672A
Pressure gauge set assy. HEA(MPa)	2383995
Airless Vector Pro gun, 1/4", incl. TradeTip 3 nozzle holder, with 4-finger trigger	538040
HEA ProTip 517	554517

### ACCESSORIES

HEA ProTip, different sizes (e.g. tip 211 - Art.No. 517211)	554XXX
TradeTip 3 FineFinish nozzles, different sizes	554XXX
5 litre hopper	704-453
HP hose DN4, 27 MPa, NPS 1/4", 7.5 m	9984573
Nozzle extension, 15 cm, G-thread	556074

**T** ≤ 0.023"; **Y** 2 l/min

## PROSPRAY 3.21 HEA SPRAYPACK - DPPS 532089

Basic unit, PS 3.21	-
HP hose DN6, 27 MPa, NPSM 1/4", 15 m	9984574
Pressure gauge set assy. HEA(MPa)	2383995
Airless Vector Grip gun, 1/4", incl. TradeTip 3 nozzle holder, with 2- and 4-finger trigger	538043
HEA ProTip 517	554517

### ACCESSORIES

TradeTip 3 FineFinish nozzles, different sizes (e.g. tip 211 - Art. No. 517211)	554XXX
Nozzles TradeTip 3, different sizes	553XXX
Nozzle extension, 15 cm, G-thread	556074
Nozzle extension, 60 cm, G-thread	556077
TipClean; 200ml	2400215
EasyGlide, special oil, 118 ml	508619

# PROSPRAY 3.25 SPRAYPACK



A compact emulsion unit for medium-sized objects

- **Innovative ProSpray product features:** Digital information readout and unit control directly on the device - piston oiled at the touch of a button - inlet valve depressor for high operating reliability - and more
- **Easy to handle:** Compact design for ease of transport and space-saving storage



- **Lightweight:** Just 17.9 kg (skid version) or 27.4 kg (cart version)
- **Two versions:** Available on trolley or as a compact Skid version

### Clearly arranged - DESC-Control:

With the digital display you can read out and handle machine data, consumption figures, runtimes and much more. The intelligent deadband control, SlowMotion function and FrequentClean guarantee trouble-free work and quick cleaning

### Maintenance-free, brushless direct current motor:

Due to the improved performance, the motor works even more efficiently at low and also at high speeds. The continuous paint pressure measurement controls the motor speed automatically, thus ensuring a constant material pressure

**Superb Spray Surface Quality:** with the Vector Grip Airless gun. Light in weight with a long service life

**Maintenance made easy:** With the push of a button the piston is oiled and thus the packings are conserved

**Inlet pusher valve:** for a high operating reliability and easy commissioning. Just the press of a finger, and the valve is free

Also available as skid version



**T** ≤ 0.027"; **Y** 2.6 l/min

### PROSPRAY 3.25 SPRAYPACK - DPPS

Basic unit, PS 3.25 on cart	-
HP hose DN6, 27 MPa, NPSM 1/4", 15 m	9984574
Airless Vector Grip gun, 1/4", incl. TradeTip 3 nozzle holder, with 2- and 4-finger trigger	538043
2SpeedTip, D10, 111 / 419	271045

**PROSPRAY 3.25 SPRAYPACK - SKID VERSION** 2308259

**PROSPRAY 3.25 SPRAYPACK - CART VERSION** 2308260

### ACCESSORIES

TradeTip 3 FineFinish nozzles, different sizes (e.g. tip 211 - Art. No. 517211)	554XXX
Nozzles TradeTip 3, different sizes	553XXX
Nozzle extension, 15 cm, G-thread	556074
Nozzle extension, 60 cm, G-thread	556077
TipClean; 200ml	2400215
EasyGlide, special oil, 118 ml	508619

# PROSPRAY 3.31 SPRAYPACK



A reliable unit for large-area emulsion work

- **Electronic control, information and management directly on the device:** displays the current pressure, pressure settings can be set and displayed, and much more
- **No-maintenance brushless motor**



- **High coverage performance together with easy operation**
- **Innovative ProSpray product features:** Digital information readout and unit control directly on the device - tilting carriage - integrated high-pressure filter - and more

**Superb Spray Surface Quality:** with the Vector Grip Airless gun. Light in weight with a long service life

**No nozzle blockages:** The high pressure filter is easily accessible and quick to clean. Three different filter inserts (fine, medium, coarse) ensure an optimal match with the material

**Tilting cart:** Fast change of the container. Site-optimised tyres allow convenient pump transport

**Clearly arranged - DESC-Control:** With the digital display you can read out and handle machine data, consumption figures, runtimes and much more. The intelligent deadband control, SlowMotion function and FrequentClean guarantee trouble-free work

**Maintenance-free, brushless direct current motor:** Due to the improved performance, the motor works even more efficiently at low and also at high speeds. The continuous paint pressure measurement controls the motor speed automatically, thus ensuring a constant material pressure

**T** ≤ 0.032"; **Y** 3.8 l/min

### PROSPRAY 3.31 SPRAYPACK - DPPS

Basic unit, ProSpray 3.31	-
HP hose DN6, 27 MPa, NPSM 1/4", 15 m	9984574
Airless Vector Grip gun, 1/4", incl. TradeTip 3 nozzle holder, with 2- and 4-finger trigger	538043
2SpeedTip, D20, 115/421	271046

### ACCESSORIES

TradeTip 3 FineFinish nozzles, different sizes (e.g. tip 211 - Art. No. 517211)	554XXX
Nozzles TradeTip 3, different sizes	553XXX
Nozzle extension, 15 cm, G-thread	556074
Nozzle extension, 60 cm, G-thread	556077
TipClean; 200ml	2400215
EasyGlide, special oil, 118 ml	508619

# PROSPRAY 3.34 SPRAYPACK



A technology masterpiece for high-viscosity materials such as flame retardants and corrosion-proofing products

- **This high-performance piston pump:** is ideally suited for large building sites where it is also able to handle high-viscosity materials
- **No-maintenance brushless motor**
- **For large building sites:** Powerful and robust



- **Faster than ever:** Quick-change fluid section for ease of servicing and shorter reaction times
- **Innovative ProSpray product features:** Digital information readout and unit control directly on the device - tilting cart - integrated high-pressure filter - and more.

**Superb Spray Surface Quality:** with the Vector Grip Airless gun. Light in weight with a long service life

**No nozzle blockages:** The high pressure filter is easily accessible and quick to clean. Three different filter inserts (fine, medium, coarse) ensure an optimal match with the material

**Tilting cart:** Fast change of the container. Site-optimised tyres allow convenient pump transport

**Clearly arranged - DESC-Control:** With the digital display you can read out and handle machine data, consumption figures, runtimes and much more. The intelligent deadband control, SlowMotion function and FrequentClean guarantee trouble-free work and quick cleaning

**Maintenance-free, brushless direct current motor:** Due to the improved performance, the motor works even more efficiently at low and also at high speeds. The continuous paint pressure measurement controls the motor speed automatically, thus ensuring a constant material pressure

**Low maintenance costs:** The practical, self-adjusting packings lead to less wear and are easy to change. They have a service life up to 50% longer than comparable packings

**Simple and quick:** Change of the suction system without tools



≤ 0.034"; 4.5 l/min

## PROSPRAY 3.34 SPRAYPACK - DPPS 2308263

Basic unit, PS 3.34	-
HP hose DN6, 27 MPa, NPSM 1/4", 15 m	9984574
Airless Vector Grip gun, 1/4", incl. TradeTip 3 nozzle holder, with 2- and 4-finger trigger	538043
2SpeedTip, D20, 115/421	271046

## ACCESSORIES

TradeTip 3 FineFinish nozzles, different sizes (e.g. tip 211 - Art. No. 517211)	554XXX
Nozzles TradeTip 3, different sizes	553XXX
Nozzle extension, 15 cm, G-thread	556074
Nozzle extension, 60 cm, G-thread	556077
TipClean; 200ml	2400215
EasyGlide, special oil, 118 ml	508619

# PROSPRAY 3.39 SPRAYPACK



Powerful emulsion unit for large areas

- **More power:** Greater suction performance thanks to the low position of the suction valve
- **Twice as fast with emulsion:** Parallel two-gun operation possible
- **The most powerful pump in the ProSpray family:** Even able to cope with Airless spraying fillers



- **Innovative ProSpray product features:** Tilting cart - change paints without using tools

**Superb Spray Surface Quality:** with the Vector Grip Airless gun. Light in weight with a long service life

**No nozzle blockages:** The high pressure filter is easily accessible and quick to clean. Three different filter inserts (fine, medium, coarse) ensure an optimal match with the material

**Tilting cart:** Fast change of the container. Site-optimised tyres allow convenient pump transport

**Clearly arranged - DESC-Control:** With the digital display you can read out and handle machine data, consumption figures, runtimes and much more. The intelligent deadband control, SlowMotion function and FrequentClean guarantee trouble-free work and quick cleaning

**Maintenance-free, brushless direct current motor:** Due to the improved performance, the motor works even more efficiently at low and also at high speeds. The continuous paint pressure measurement controls the motor speed automatically, thus ensuring a constant material pressure

**Low maintenance costs:** The practical, self-adjusting packings lead to less wear and are easy to change. They have a service life up to 50% longer than comparable packings



**Also available as filler version with Airless gun AG 19**



≤ 0.039"; 5 l/min

## PROSPRAY 3.39 EMULSION SPRAYPACK - DPPS 2351261

Basic unit, PS 3.39	-
HP hose DN6, 27 MPa, NPSM 1/4", 15 m	9984574
Airless Vector Grip gun, 1/4", incl. TradeTip 3 nozzle holder, with 2- and 4-finger trigger	538043
2SpeedTip, D40, 117/427	271048
Double connector A = 1/4" NPS x 3/8" NPT	812-003
Double connector A = 3/8" NPT x A = 1/2" NPS	815-005

## PROSPRAY 3.39 FILLER SPRAYPACK - DPPS 2308264

Basic unit, PS 3.39	-
HP hose DN13, max. 25 MPa, 3/8", NPSM 1/2", 15 m	2336585
Hose whip DN10, max. 25 MPa, NPSM 3/8", 2.5 m	2336582
Airless gun AG 19, 25 MPa, G-thread 3/8", incl. TradeTip 3 nozzle holder	2341127
2SpeedTip, S10, 235/527	271049
Coupling sleeve I = 1/4"NPSM x A = 3/8"NPSM, 27 MPa	179732
Connector 3/8" x 1/2"	814-005



## HYDRAULIC PISTON PUMP

### Even more suction and delivery power - with denser materials

Do you mostly work with particularly high-viscosity or very dense materials? Then a WAGNER piston pump is the perfect, reliable site companion for you. The exceptionally high suction and transport power is produced by the piston's stroke movement. This is amplified even further by the hydraulic drive and is particularly ideal for this type of material.

#### Various performance classes for every professional:

the especially reliable hydraulic pump technology from WAGNER is most suited to large construction sites, with a broad spectrum of applications from building protection and emulsion through to especially high-viscosity and very dense materials for use inside and out.

#### 1. WITH EVEN MORE POWER ON THE CONSTRUCTION SITE:

The patented SSP (Special Spray Power) system from WAGNER is a technology that is unique on the market for the application of high viscosity materials. The special design of the system ensures that the pump is continually filled with sufficient material by the shovel piston. SSP is available for all HeavyCoat models.

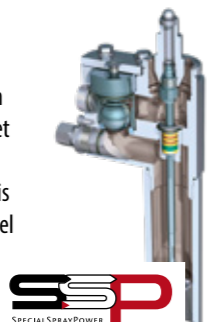

Additional power "Special-Spray-Power" for high viscosity materials

#### A powerful companion - inside and out:

WAGNER piston pumps are available with three different drive systems. Electric piston pumps cover a wide range of performance classes and have a compact design. The hydraulic piston pumps offer even better performance and are available with a choice of either petrol or electric motors which can be switched in a few minutes. Pneumatically driven piston pumps from WAGNER are explosion-proof and therefore are suitable for use in workshops.

#### 2. NO CONTINUOUS RUNNING:

Piston pumps only operate when you have to build up pressure. The rest of the time, the drive is on 'standby'. This protects wear parts and has a positive impact on site noise levels.



## CROSS-SECTION OF THE PISTON



Hydraulic

upper packing

outlet-valve

lower packing

inlet-valve

## ADVANTAGES

- Better delivery capacity with extreme high viscosity materials
- Less sensitive to heavily filled materials
- High material pressure / material volume allow long hose lengths
- Large nozzle sizes can be used
- Extra-durable packing
- Powerful suction
- Für zusätzliche Leistung umrüstbar auf SSP

## HEAVYCOAT 750 SPRAYPACK

### Compact power pack for heavy material



- **Long service and reliability:** thanks to Hydra-stroke technology, the operating temperature is significantly reduced, thereby increasing the service life.
- **New hydraulic design:** inspired by mining and aviation for the toughest demands in terms of the piston pump's working and delivery performance.
- **Powerful:** constant performance for the application of



heavy, filled and high-viscosity materials such as bitumen and textured plaster over large areas.

- **Superb performance and perfect surface results:** even with long hoses.
- **Maximum user-friendliness:** thanks to simple operation.

**High pressure filter:** for high reliability and minimal downtime

**It is a quick and easy task:** to depressurise the unit

**Hydrastroke technology:** the operating temperature is reduced by up to 14 °C in comparison to previous hydraulic systems

**Bucket holder:** easy transport of the material bucket

**Ease of maintenance:** Pump and motor are easily accessible and the lower pump can be removed by loosening just 4 screws. This makes the HC 750 particularly maintenance-friendly

**Ideal cooling:** The robust design of the housing cover with integrated ventilation slots conducts air over all device components that convey hydraulic fluid



**Quality spraying:** with the high-performance gun AG 14. When used in combination with the 2SpeedTip nozzle for fillers, it is possible to handle even high-viscosity materials without difficulty

**Available as an electrically driven or petrol-driven model:** The basic model without SSP is also available with a petrol motor. This means that it can also be used on construction sites without an electrical connection

**Large pneumatic tyres:** mean that the unit is easy and comfortable to transport, even on difficult terrain

**Low valve or optionally selectable SSP shovel piston:** enable processing of extremely high-viscosity materials

≤ 0.043"; 6 l/min (E) / 7,6 l/min (G)

#### HEAVYCOAT 750 E SPRAYPACK - DPHC 2371027

Basic unit, HC 750 E	-
HP hose DN13, max. 25 MPa, 3/8", NPSM 1/2", 15 m	2336585
Hose whip DN10, max. 25 MPa, NPSM 3/8", 2.5 m	2336582
Connector 3/8" x 1/2"	814-005
Airless gun AG 14, G-thread 1/4", incl. TradeTip 3 nozzle holder	0502081A
2SpeedTip, S10, 235/527	271049
Übergangsstutzen I = 1/4"NPSM x A = 3/8"NPSM; 27 MPa	179732

#### HEAVYCOAT 750 E SPRAYPACK - DPHC 2371027

#### HEAVYCOAT 750 G SPRAYPACK - DPHC 2371029

≤ 0.043"; 6 l/min (E) / 7,6 l/min (G)

#### HEAVYCOAT 750 E SSP SPRAYPACK

Basic unit; HeavyCoat 750 E SSP	-
HP hose DN13, max. 25 MPa, 3/8", NPSM 1/2", 15 m	2336585
Hose whip DN10, max. 25 MPa, NPSM 3/8", 2.5 m	2336582
Connector 3/8" x 1/2"	814-005
Airless gun AG 14, G-thread 1/4"; incl. TradeTip 3 nozzle holder	0502081A
2SpeedTip, S10, 235 / 527	271049

#### HEAVYCOAT 750 E SSP SPRAYPACK - DPHC 2371028

# HEAVYCOAT 950 SPRAYPACK



## Power pack for the heaviest material

- **Versatile in use:** Thanks to high delivery capacity.
- **Powerful but light:** Compact for ease of transport.
- **Innovative HeavyCoat product features:** fast container changeovers, easy to clean and transport thanks to the swivelling SwingCart pump unit
- **SSP version:** with shovel piston for extra performance with high viscosity materials.



**Quality spraying:** with the high-performance gun AG 14. When used in combination with the 2SpeedTip nozzle for fillers, it is possible to handle even high-viscosity materials without difficulty

**Swing-Cart:** makes it possible to swing up the pump. Practical when working from a bucket or a container but also for transport

**Tidied up:** With the integral support hoses up to a length of 60 m can be practically stowed away

**High pressure filter:** for high reliability and minimal downtime

**Convenience:** The adjustable height telescopic handle makes for convenient transport on the building site or in the in a vehicle

**In a single action:** the unit can be safely depressurised and quickly cleaned

**HeavyCoat special hose:** with a 3/8", 1/2" or 3/4" cross section for a better spraying performance

**You have the choice:** with or without SSP shovel piston for processing of very high-viscosity materials



**T** ≤ 0.052"; **W** 6.6 l/min (E) / 8 l/min (G)

### HEAVYCOAT 950 SPRAYPACK - DPHC

Basic unit, HC 950 E	-
HP hose DN10, max. 25 MPa, NPSM 3/8", 15 m	2336583
Coupling sleeve I = 1/4"NPSM x A = 3/8"NPSM, 27 MPa	179732
Airless gun AG 14, G-thread 1/4", incl. TradeTip 3 nozzle holder	0502081A
2SpeedTip, D40, 117/427	271048

**HEAVYCOAT 950 E SPRAYPACK - DPHC** 2332184

**HEAVYCOAT 950 G SPRAYPACK - DPHC** 2332186

**T** ≤ 0.052"; **W** 6.6 l/min (E) / 8 l/min (G)

### HEAVYCOAT 950 E SSP SPRAYPACK

Basic unit; HeavyCoat 950 E SSP	-
HP hose DN13, max. 25 MPa, 3/8", NPSM 1/2", 15 m	2336585
Hose whip DN10, max. 25 MPa, NPSM 3/8", 2.5 m	2336582
Connector 3/8" x 1/2"	814-005
Airless gun AG 19, 25 MPa, G-thread 3/8", incl. TradeTip 3 nozzle holder	2341127
2SpeedTip, S20, 243 / 539	271050

**HEAVYCOAT 950 E SSP SPRAYPACK - DPHC** 2332187

# HEAVYCOAT 970 SPRAYPACK



## All-round Xtra speed for XL projects

- **WAGNERs most powerful hydraulic piston pump**
- **The perfect choice:** For large areas and intensive usage
- **Maximised capacity:** With a delivery volume of 10-12 l/min
- **Innovative HeavyCoat product features:** with a choice of either a petrol or electric motor which can be interchanged in a few minutes – or optionally even more

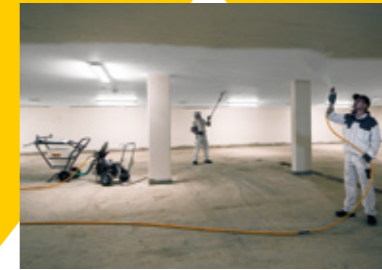

- power with SSP
- **Fast container changeovers, easy to clean and transport:** thanks to the swivelling SwingCart pump unit
- **SSP version:** with shovel piston for extra performance with high viscosity materials.

**Quality spraying:** in the high performance range too – with the AG 19 professional gun from WAGNER. In combination with the 2SpeedTip nozzle system even high viscosity materials can be sprayed without problems

**Swing-Cart:** makes it possible to swing up the pump. Practical when working from a bucket or a container but also for transport

**Tidy:** with the integral support hoses up to a length of 60 m can be practically stowed away

**High pressure filter:** for high reliability and minimal downtime

**Convenience:** The adjustable height telescopic handle makes for convenient transport on the building site or in the vehicle

**With a choice of electric drive or independent of mains electricity with the Honda petrol engine:** The units can be converted from electric to petrol drive (or vice versa). This makes them able to be used on building sites with no power supply. Both motors are extremely reliable and longlasting



**T** ≤ 0.056"; **W** 10,3 l/min (E) / 12 l/min (G)

### HEAVYCOAT 970 SPRAYPACK - DPHC

Basic unit, HC 970 E / 970 G	-
HP hose DN13, max. 25 MPa, 3/8", NPSM 1/2", 15 m	2336585
Hose whip DN10, max. 25 MPa, NPSM 3/8", 2.5 m	2336582
Connector 3/8" x 1/2"	814-005
Coupling sleeve I = 1/4"NPSM x A = 3/8"NPSM, 27 MPa	179732
Airless gun AG 14, G-thread 1/4", incl. TradeTip 3 nozzle holder	0502081A
2SpeedTip, S20, 243/539	271050

**HEAVYCOAT 970 E SPRAYPACK - DPHC** 2332191

**HEAVYCOAT 970 G SPRAYPACK - DPHC** 2332192

**T** ≤ 0.056"; **W** 10,3 l/min (E) / 12 l/min (G)

### HEAVYCOAT 970 E SSP SPRAYPACK

Basic unit; HeavyCoat 970 E SSP	-
HP hose DN13, max. 25 MPa, 3/8", NPSM 1/2", 15 m	2336585
Hose whip DN10, max. 25 MPa, NPSM 3/8", 2.5 m	2336582
Connector 3/8" x 1/2"	814-005
Airless gun AG 19, 25 MPa, G-thread 3/8", incl. TradeTip 3 nozzle holder	2341127
2SpeedTip, S20, 243 / 539	271050

**HEAVYCOAT 970 E SSP SPRAYPACK - DPHC** 2332193

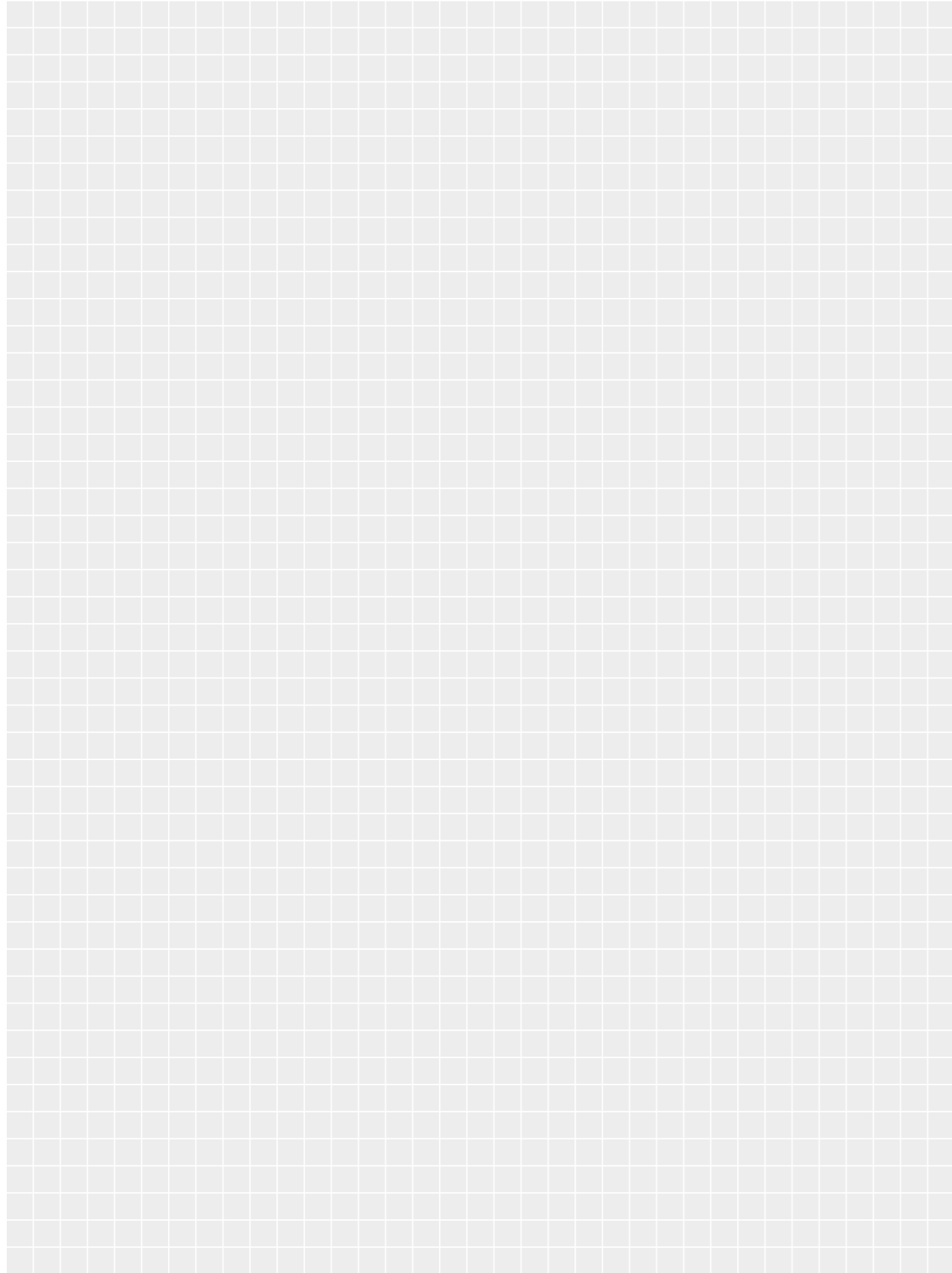

# SPIRAL PUMP

## Simple operation – powerful and versatile



Do you appreciate the machine-based application of material, especially for harder tasks? Then a spiral pump from WAGNER is exactly the strong power packet you need for your construction sites. The robust, powerful performance of a spiral pump is delivered by a really simple rotor-stator function that WAGNER has been successfully using on the market for decades.

### Robust, faithful reliable power packet for those difficult tasks:

Spiral pumps, also called eccentric spiral pumps, use displacement mechanisms to deliver the material. Two components, the rotor and the stator, are used for this. The rotor rotates and in doing so transports the material gently through the cavities of the stator. This simple function enables extremely heavy materials with different granulation and even fibres, such as render and other materials containing fillers, to be processed extremely efficiently.

### The solution for heavy, textured material:

WAGNER spiral pumps can be used to achieve high-quality surfaces at a high working speed, for example with machine-assisted plaster application. Here the heavy, highly viscous material is moved with the help of the spiral pump through the hose to the spray gun, where it is atomized and applied smoothly. Comfortable and controlled, just like you're used to with WAGNER airless spray devices.

### 1. EASY TO OPERATE:

The simple, user-friendly operating concept for controlling the rotor and stator guarantees problem-free use, even for beginners.

### 2. FAST CLEANING:

WAGNER spiral pumps can be quickly disassembled for cleaning and maintenance and reassembled again thanks to the simple stator design, including directly on the construction site. This is made especially easy on the WAGNER PlastCoat 1030 by the automatic stator withdrawal. The material-carrying parts are also made from special materials which are easy to clean.

### 3. LONG SERVICE LIFE:

WAGNER spiral pumps are robust and easy to use. They are especially low-wear and low-maintenance, and are considerably quieter in operation than conventional piston pumps.

## CROSS-SECTION OF THE SPIRAL PUMP

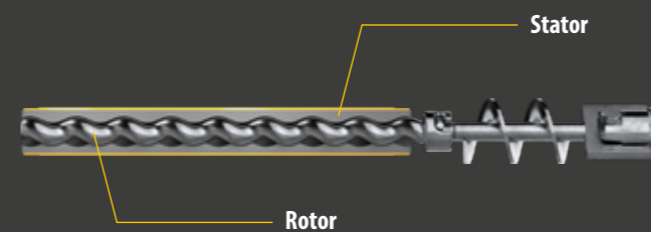

## ADVANTAGES

- Simple and sturdy technology
- Gentle material transport
- Powerful processing of highly viscous materials
- Fully adjustable control of spray pressure
- Long lifespans
- Low maintenance

# PLASTCOAT HP 30



## Uniting the best – robust high-pressure spiral pump with airless technology for high-viscosity fillers

- **Simplest handling:** The user-friendly operating concept enables error-free application – even for beginners.
- **The ergonomic airless gun and the high pressure hose:** guarantee a high level of operating comfort during material application.
- **Maximum performance:** The PlastCoat HP 30 provides a convincing delivery capacity of >10kg/min.



The spraying pressure can also be freely adjusted (40-120 bar).

- **Exceptionally reliable:** The low-wear and low-maintenance spiral pump is characterised by its robust and proven technology.

**High-performance guns:** With the airless gun AG 19, even high-viscosity materials can be processed without any problems



**Colour-coordinated pressure gauge:** Allows perfect control of the pressure in coordination with the material being processed

**Plastic material hopper:** Easy to clean and with a capacity of 50 litres. Cover for the material hopper available separately as an accessory (Art. No. 2400 030)

**Compact dimensions:** With a height of 62 cm, the device can easily be filled with material



**Easy control:** Thanks to the user friendly control panel

**Perfect for every construction site:** The large, pneumatic tyres ensure mobility on any construction site

**Quiet and comfortable airless spraying:** without additional compressor with up to 120 bar working pressure

**Also available as emulsion version**



**Can easily be converted for emulsion work:** With the emulsion kit comprising a 15 m hose (DN 10) and the Vector Pro gun with HEA nozzle 517 (2400684)

≤ 0.055" ; > 10 kg/min

### PLASTCOAT HP 30 SPRAYPACK - DPPC 2388301

Basic unit, PC HP 30	-
HP hose Ø19, 10m	2390763
HP whip hose, DN10, 2.5 m	2390762
Airless gun AG 19, 25 MPa, G-thread 3/8", incl. TradeTip 3 nozzle holder	2341127
TradeTip 3 nozzle 443	553443
PlastGuard longlasting pump protector	2399960

### EMULSION SET PLASTCOAT HP 30 2400684

Airless gun Vector Pro, 1/4", incl. TradeTip 3 nozzle holder, with 4-finger trigger	538040
HP hose DN10, max. 25 MPa, NPSM 3/8", 15 m	2336583
HEA ProTip nozzle 517	554517
Adapter FM 1/2BSPP-3/8NPSM	2332623
Adapter FM 1/4 NPSM-3/8NPSM	179732

## PRACTICAL ACCESSORIES HP 30

HOSES	
HP hose Ø19, 10m	2390763
HP whip hose, DN10, 2.5m	2390762
HP hose DN10, max. 25 MPa, NPSM 3/8", 15 m	2336583

SPRAY GUNS AND NOZZLES	
Airless gun AG 19, 25 MPa, G-thread 3/8", incl. TradeTip 3 nozzle holder	2341127
Airless gun Vector Pro, 1/4", incl. TradeTip 3 nozzle holder, with 4-finger trigger	538040
TradeTip 3 nozzles, different sizes	0553XXX
HEA ProTip nozzles, different sizes	0554XXX
Nozzle holder, G-thread 7/8", for TradeTip 3 nozzles	0289390

OTHER	
Nozzle extension, 30 cm, G-thread	556075
Nozzle extension, 60 cm, G-thread	556077
Cleaning ball DN16	2402355
Cleaning ball DN19	342330
Rotor and stator, complete, for PlastCoat HP 30	2395996
Cover for material hopper	2400030
Press table	2389048
PlastGuard pump protector	2399959
PlastGuard longlasting pump protector	2399960

## RECOMMENDED USE

MATERIALS:	
Emulsion and latex paints, adhesives, sealants	Structural waterproofing, bituminous coatings

Exterior paints, roof coatings, floor coatings, textured paint	Filler
----------------------------------------------------------------	--------

### OBJECT SIZE:



## TECHNICAL DATA

Weight	72 kg
Motor power	2.3 kW
Voltage	230 V / 50 Hz
Max. operating pressure	120 bar, 12 MPa
Max. delivery rate (airless emulsion spray filler)	> 10 kg / min
Max. feed height	20 m
Max. delivery radius	22.5 m
Max. grain size *	0.3 mm

\*Airless fillers, emulsion fillers

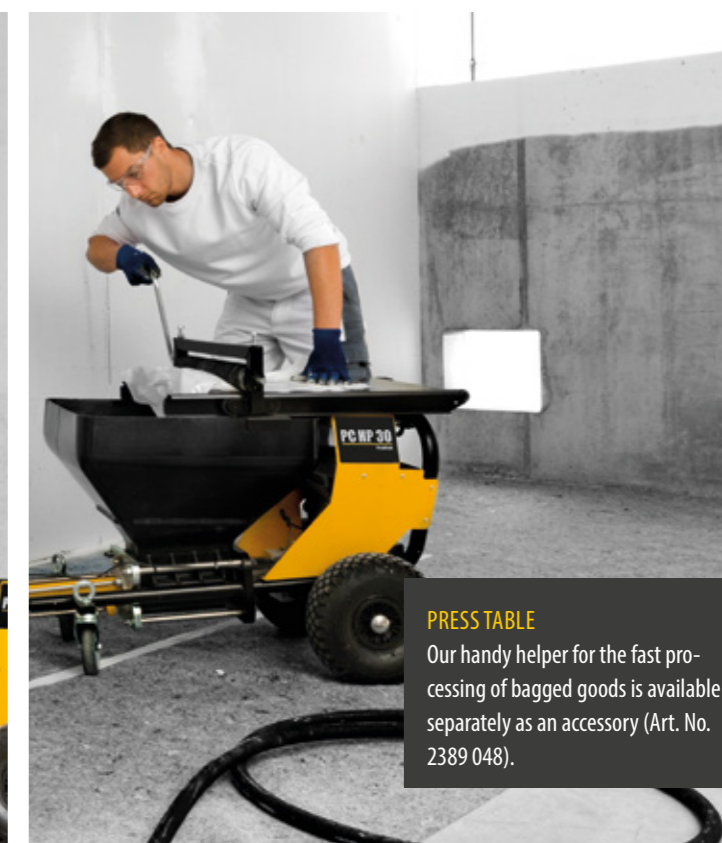

**PRESS TABLE**  
Our handy helper for the fast processing of bagged goods is available separately as an accessory (Art. No. 2389 048).

# PLASTCOAT 1030 E SPRAYPACK



The power to handle large volumes – compact and versatile

- **Compact and lightweight:** 58 kg of weight with a delivery height of 20 m and delivery radius of 40 m, materials up to a grain size of 6 mm supported
- **Easy cleaning for use on building sites:** automatic stator extraction and automatic pressure release
- **For large surfaces and easy transport:** integrated 50-litre plastic container, four wheels



- and a low overall height
- **Maintenance-free and robust:** brushless DC motor for a high torque
- **Closing the gun turns off the pump (electrically)**

**Plastic materialhopper:** for an easy cleaning with a capacity of up to 50 litre

**Included in scope of delivery:** PC 1030 comes complete ready to spray incl. mortar hose (DN 25, 10 m), automatic spraying lance with nozzle and toolbox

**Perfectly equipped for all construction sites:** Big, pneumatic tires ensures mobility on all construction sites

**Compact dimensions:** With a height of 62 cm the unit can be easily filled using buckets or combined with a flow mixer

**Automatic stator extraction:** Fast separation of pump and suction system, also great for quick assembly. Ideal for easy cleaning and transport

**Ergonomic spraying lance:** Due to its modular construction and accessories (e.g. the lance extension) the spraying lance can adapt quickly to any project

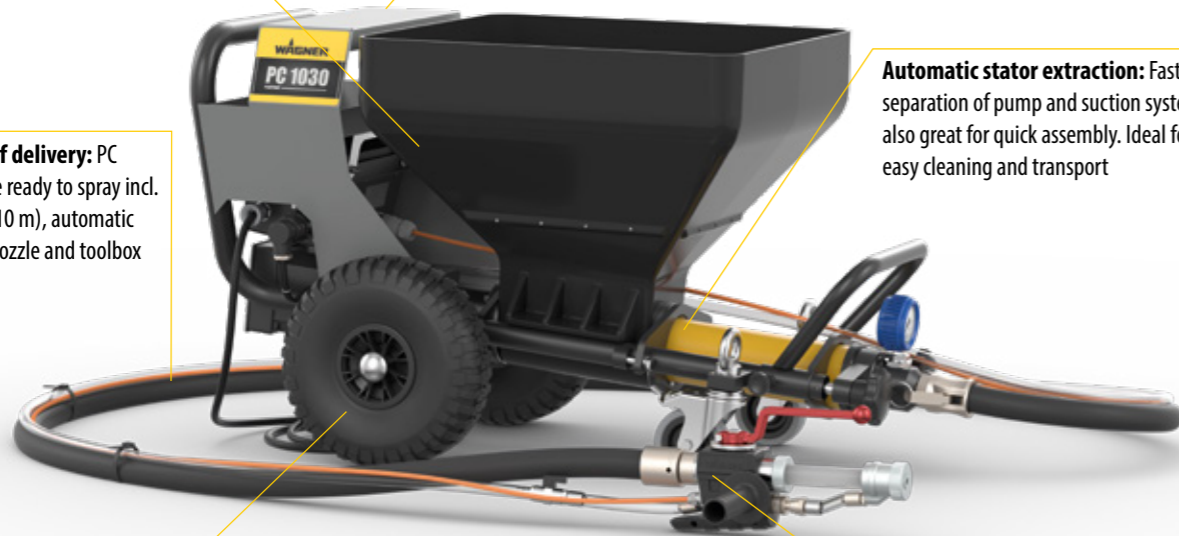

15 l/min

## PLASTCOAT 1030 E SPRAYPACK - DPPC 2361588

Basic unit, PlastCoat 1030 E	-
Mortar hose DN25, M/V35, 10 m, including air hose and control cable	2325197
Spraying lance, automatic, incl. 6 mm nozzle	2334115
Pump lubricant 500 ml	9992824
Tool box, premium, without content	348450

### ACCESSORIES

Pump worm W10/3, Ø = 40 mm, L = 320 mm, yellow	348316
Pump worm W15/2, Ø = 40 mm, L = 320 mm, brown	348926
Pump casing W10/3, 270x89, yellow	348315
Pump casing W15/2, 270x89, brown	348925



# PLASTMAX SPRAYPACK



Versatile mixing pump for the economical application of mineral and viscous materials

- **Complete solution:** Mixing, pumping and spraying with a single unit
- **User-friendly and powerful:** clearly arranged control panel including speed inverter and material flow rate
- **Easy transport and quick cleaning:** the tiltable mixing chamber and the quick stator changing allow an easy cleaning. For transport the unit can be disassembled into



- four modules
- **Easy to maintain and durable:** self-priming water pump with stainless steel case and brass impeller
- **Integrated compressor:** dirt resistant and oil-free compressed air for low maintenance

**Bag opener:** allows quick filling of the material container.

**Easy to handle:** thanks to clearly laid-out control panel.

**Durable compressor:** unaffected by dirt thanks to oil-free compressed air.

**Maximum safety at work:** the integrated safety grille and comfortable filling height ensure safe and ergonomic working.

**Large material funnel:** avoids interruption of work as material only requires refilling infrequently.

**Easy cleaning and assembly:** the angle of inclination can be adjusted with a lever.



15 l/min

## PLASTMAX SPRAYPACK - DPPC 2361587

Base unit, PlastMax	-
Mortar hose DN25, M/V25, 10 m incl. air hose	2325182
In-wall lance, pneumatic	2334122
Accessory box, complete, for PlastMax	2362233

### ACCESSORIES

PlastMax Mixing shaft, light materials	2366915
Rotor PlastMax D5-2,5	2363614
Stator PlastMax D5 - 2,5	2363615
Stator PlastMax D4-1/2	2366948
Rotor PlastMax D4-1/2	2366947
Rotor PlastMax D4 -1/4	2366951



## TEMPSPRAY AIRLESS HEATED HOSE

### Optimised for spraying highly viscous materials without dilution

Would you always like to ensure the ideal processing temperature and best viscosity of the material you are spraying, regardless of any seasonal fluctuations in temperature? The TempSpray heated hose from WAGNER is your guarantee for the best possible surface quality. The electric heating element, located directly in the flow of paint inside the hose system, heats the material evenly over the entire length of the hose to the pre-set temperature.



#### Heat up instead of diluting:

The ideal viscosity, along with the right working technique and equipment, are crucial for impressive results when spraying. If material is too thick, the result is an irregular spray pattern and a poor paint application. To make coating materials sprayable they usually have to be diluted. Heating the material with a TempSpray heated hose system from WAGNER has the same effect: viscosity is reduced, improving the application of the material. The result is a soft spray pattern and optimised atomisation quality.

#### 1. LESS SOLVENT, VOC-COMPLIANT:

Heating the material reduces the amount of solvent needed since the material no longer needs to be diluted to achieve the required spray viscosity.

#### 2. LOWER SPRAY PRESSURE:

Heating reduces the material's viscosity, allowing a lower spray pressure to be used. This reduces the overspray, protects the device being used and also protects the operator.

#### Perfectly equipped for every area of application:

Heating the material in the heated hose improves the spraying properties of numerous coating materials - from stains and lacquers through to adhesives. The TempSpray systems can be fully controlled from 20° to 60°C. They can be used with all WAGNER airless devices, offering a broad range of applications.

## CHANGE IN VISCOSITY

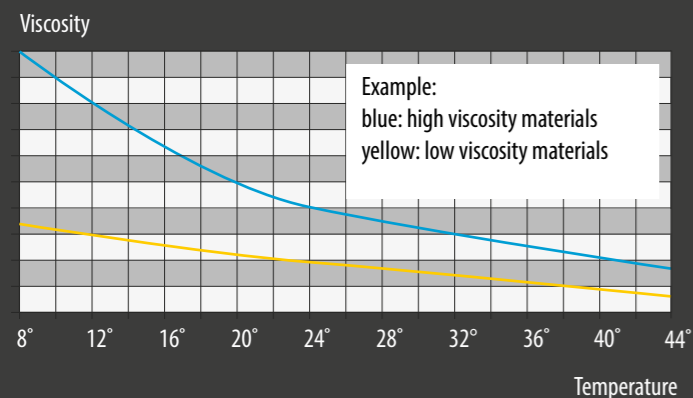

## ADVANTAGES

- Easy to use
- Reduction of overspray
- Paint savings thanks to less overspray
- Increase in the thickness of the layers applied
- Less wear and tear on the device
- Constant paint temperature, even when outdoor temperatures are low
- Excellent edge coverage

## TEMPSPRAY H 126 SPRAYPACK



The system that simplifies your work – perfect surface finishes through reduced viscosity with material heating

- **Easy to use:** specially designed for paint jobs, easily adapted for use with all Airless devices
- **Effortless operation:** flexible, steel-reinforced DN6 hose
- **Flexible:** continuous temperature regulation from 20° C - 60° C
- **Lightweight:** weighs only 3.5 kg



- **Suitable for the following materials:** wood preservative, oils, stains, primers, undercoats, fillers, lacquers, 2K materials (Check the pot life)

**Spray with excellent surface quality:** the Vector Grip Airless gun is lightweight and has a long service life

#### Perfect surface finish with TempSpray:

heating of the coating material produces a soft spray pattern and therefore perfect atomisation. Other advantages include less overspray, perfect viscosity without dilution and much more

**Also available as a base unit for combining with existing Airless guns**



**Also ideal in combination with AirCoat for very fine atomisation**



**Clearly laid-out control unit:** the required temperature can be fully adjusted from 20°C to 60°C as needed by pressing the arrow buttons

**Compact unit:** thanks to integrated heating element

**Flexible and robust:** 10-metre-long DN6 stainless steel hose

#### TEMPSPRAY H 126 SPRAYPACK - DPTS 2311852

TempSpray H 126 Basic Unit, 10 m	2311659
Airless Vector Grip gun, 1/4", incl. TradeTip 3 nozzle holder, with 2- and 4-finger trigger	538043
2SpeedTip, L10, 208 / 510	271042

#### BASIC UNIT

TempSpray H 126 Basic Unit, 10 m	2311659
----------------------------------	---------

#### TEMPSPRAY H 126 AIRCOAT

TempSpray H 126 Basic Unit, 10 m	2311659
AirCoat gun AC 4600 Professional, incl. blue air cap and holder	394156
Air hose DN6, 10 cm, for AirCoat applications	344905
AirCoat ACF 3000 nozzles	379xxx
AirCoat ACF 3000 Plus nozzles	321xxx

# TEMPSPRAY H 226 SPRAYPACK



Practical material heating system – for emulsions and latex paints

- **Specially designed for emulsions, latex paints**
- **Practical:** trolley-mounted hose reel for simple transportation on building sites
- **Flexible:** for indoor and outdoor use, easily adapted to all Airless units

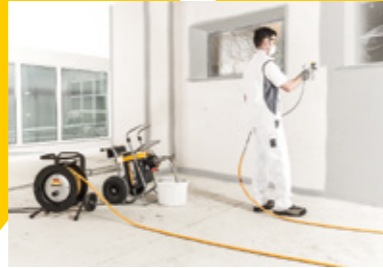

- **Suitable for the following materials:** thick materials, high solids, emulsion paints, latex paints, exterior protection, roof coatings

# TEMPSPRAY H 326 SPRAYPACK



The longest TempSpray of all time – for extended versatility and working radius

- **Ideal for emulsions, masonry, facade paints**
- **Twice the working radius for indoor and outdoor work:** 30 m heated hose
- **Practical:** large trolley-mounted hose reel for simple transportation on building sites
- **Suitable for the following materials:** thick materials, high solids, emulsion paints, latex paints, exterior



- protection, roof coatings, corrosion proofing, bitumen, adhesives

**Spray with excellent surface quality:** The Airless Gun AG 14 is robust and has a long service life

**Mobile:** thanks to construction site-compatible reel drum

**Also available as a base unit for combining with existing Airless guns**



**Clearly laid-out control unit:** the required temperature can be fully adjusted from 20°C to 60°C as needed by pressing the arrow buttons

**Perfect surface finish with TempSpray:** heating of the coating material produces a soft spray pattern and therefore perfect atomisation. Other advantages include less overspray, perfect viscosity without dilution and much more

**Superb Spray Surface Quality:** with the AG 14 Airless gun. Robust with a long service life

**Mobile:** thanks to construction site-compatible reel drum and extra-long hose (30 m)

**Also available as a basic unit for use with existing airless guns**



**Clear control unit:** By pressing the arrow buttons, the desired temperature can be continuously adjusted from 20°C - 60°C as required

**Perfect finish with TempSpray:** Thanks to warming up the coating material a very soft spray pattern is generated. This increases the atomisation quality. Further advantages are less overspray, a perfect viscosity without thinning and much more

## BASIC UNIT

TempSpray H 226 Basic Unit, 15 m	2311660
----------------------------------	---------

## TEMPSPRAY H 226 SPRAYPACK - DPTS 2311853

TempSpray H 226 Basic Unit, 15 m	2311660
Airless gun AG 14, G-thread 1/4", incl. TradeTip 3 nozzle holder	0502081A
2SpeedTip, D10, 111 / 419	271045

## BASIC UNIT

TempSpray H 326 Basic Unit, 30 m	2311661
----------------------------------	---------

## TEMPSPRAY H 326 SPRAYPACK - DPTS 2311854

TempSpray H 326 Basic Unit, 30 m	2311661
Airless gun AG 14, G-thread 1/4", incl. TradeTip 3 nozzle holder	0502081A
2SpeedTip, D20, 115 / 421	271046

	FINISHCONTROL 3500	FINISHCONTROL 5000	FINECOAT 9900 PLUS	SUPERFINISH 23 PRO HEA	SUPERFINISH 23 PLUS HEA
Product image (may differ)					
Spraying method					
Technology					
Drive					
Voltage	230 V / 50 Hz	230 V / 50 Hz	230 V / 50 Hz	230 V / 50 Hz	230 V / 50 Hz
Motor output	0.7 kW	1.4 kW	1.5 kW	1.3 kW	1.3 kW
Max. operating pressure	0.2 bar, 0.02 MPa	0.275 bar, 0.0275 MPa	0.72 bar, 0.072 MPa	250 bar, 25 MPa	250 bar, 25 MPa
Max. delivery rate	-	-	-	2.6 l/min	2.6 l/min
Max. nozzle size	-	-	-	0.023"	0.023"
Recommended max. hose length	-	-	-	30 m	30 m
Max. viscosity	-	-	-	20.000 mPas	20.000 mPas
Weight	2.3 kg	8 kg	10 kg	27 kg	29 kg
Art. No.	2341501	2316090	276048	2399198	2384153
Categorie	DPXVLP	DPXVLP	DPFC	DPSF	DPFSF
Material					
Recommended intensity					

	SUPERFINISH 23 PLUS AIRLESS ENAMEL	SUPERFINISH 23 PLUS TEMPSPRAY	SUPERFINISH 23 PLUS AIRCOAT ENAMEL COMPRESSOR	SUPERFINISH 23 CR	SUPERFINISH 33 PRO
Product image (may differ)					
Spraying method				Injection	
Technology					
Drive					
Voltage	230 V / 50 Hz	230 V / 50 Hz	230 V / 50 Hz	230 V / 50 Hz	230 V / 50 Hz
Motor output	1.3 kW	1.3 kW	1.3 kW	1.3 kW	2.2 kW
Max. operating pressure	250 bar, 25 MPa	250 bar, 25 MPa	250 bar, 25 MPa	250 bar, 25 MPa	250 bar, 25 MPa
Max. delivery rate	2.6 l/min	2.6 l/min	2.6 l/min	2.6 l/min	4.2 l/min
Max. nozzle size	0.023"	0.023"	0.023"	-	0.033"
Recommended max. hose length	30 m	10 m	7,5 m	15 m	60 m
Max. viscosity	20.000 mPas	20.000 mPas	20.000 mPas	20.000 mPas	20.000 mPas
Weight	29 kg	29 kg	29 kg	29 kg	43 kg
Art. No.	2341492	2341496	2353393	2415601	2388260
Categorie	DPFSF	DPFSF	DPFSF	DPFSF	DPFSF
Material					
Recommended intensity					

Water and solvent-based lacquers, lacquer paints, oils, separating agents

Synthetic resin varnishes, PVC lacquers, 2K lacquers

Primers, fillers

Fire protection, rust protection paints

Emulsion and latex paints, adhesives, sealants

Exterior paints, roof coatings, floor coatings, textured paint

Structural waterproofing, bituminous coatings

Filler































Plaster













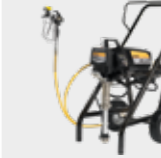















Residential

Large residential

Commercial



	SUPERFINISH 33 PLUS	POWERPAINTER 90 EXTRA - SKID VERSION	POWERPAINTER 90 EXTRA - CARD VERSION	PROSPRAY 3.20 HEA	PROSPRAY 20 HEA
Product image (may differ)					
Spraying method					
Technology					
Drive					
Voltage	230 V / 50 Hz	230 V / 50 Hz	230 V / 50 Hz	230 V / 50 Hz	230 V / 50 Hz
Motor output	2.2 kW	0.8 kW	0.8 kW	1.0 kW	0.9 kW
Max. operating pressure	250 bar, 25 MPa	200 bar, 20 MPa	207 bar, 20.7 MPa	207 bar, 20.7 MPa	214 bar, 21.4 MPa
Max. delivery rate	4.2 l/min	1.6 l/min	1.6 l/min	1.6 l/min	1.6 l/min
Max. nozzle size	0.033"	0.019"	0.019"	0.021"	0.021"
Recommended max. hose length	60 m	30 m	15 m	30 m	30 m
Max. viscosity	20.000 mPas	-	-	20.000 mPas	20.000 mPas
Weight	50 kg	10,2 kg	23 kg	13.6 kg	15.2 kg
Art. No.	2388259	2414079	2401275	2412438	2403616
Categorie	DPSF	DPPPE	DPPPE	DPPS	DPPS
Material					
Recommended intensity					

	PROSPRAY 3.21 HEA	PROSPRAY 3.25 - SKID VERSION	PROSPRAY 3.25 - CART VERSION	PROSPRAY 3.31	PROSPRAY 3.34
Product image (may differ)					
Spraying method					
Technology					
Drive					
Voltage	230 V / 50 Hz	230 V / 50 Hz	230 V / 50 Hz	230 V / 50 Hz	230 V / 50 Hz
Motor output	1.03 kW	1.1 kW	1.1 kW	1.84 kW	1.95 kW
Max. operating pressure	221 bar, 22.1 MPa	221 bar, 22.1 MPa	221 bar, 22.1 MPa	221 bar, 22.1 MPa	221 bar, 22.1 MPa
Max. delivery rate	2 l/min	2.6 l/min	2.6 l/min	3.8 l/min	4.5 l/min
Max. nozzle size	0.023"	0.027"	0.027"	0.032"	0.034"
Recommended max. hose length	30 m	30 m	30 m	60 m	60 m
Max. viscosity	20.000 mPas	25.000 mPas	25.000 mPas	25.000 mPas	25.000 mPas
Weight	17.9 kg	17.9 kg	27.4 kg	43.5 kg	47.6 kg
Art. No.	532089	2308259	2308260	2308262	2308263
Categorie	DPPS	DPPS	DPPS	DPPS	DPPS
Material					
Recommended intensity					

 Water and solvent-based lacquers, lacquer paints, oils, separating agents

 Synthetic resin varnishes, PVC lacquers, 2K lacquers

 Primers, fillers

 Fire protection, rust protection paints

 Emulsion and latex paints, adhesives, sealants

 Exterior paints, roof coatings, floor coatings, textured paint

 Structural waterproofing, bituminous coatings

 Filler

 Plaster

 Residential

 Large residential

 Commercial

	PROSPRAY 3.39 EMULSION	PROSPRAY 3.39 FILLER	HEAVYCOAT 750 E / E SSP	HEAVYCOAT 750 G	HEAVYCOAT 950 E / E SSP
Product image (may differ)					
Spraying method					
Technology					
Drive					
Voltage	230 V / 50 Hz	230 V / 50 Hz	230 V / 50 Hz	230 V / 50 Hz	230 V / 50 Hz
Motor output	2.19 kW	2.19 kW	3.1 kW	4.1 kW	3.6 kW
Max. operating pressure	221 bar, 22.1 MPa	221 bar, 22.1 MPa	250 bar, 25 MPa	250 bar, 25 MPa	250 bar, 25 MPa
Max. delivery rate	5 l/min	5 l/min	6 l/min	7.6 l/min	6.6 l/min
Max. nozzle size	0.039"	0.039"	0.043"	0.041"	0.052"
Recommended max. hose length	60 m	60 m	100 m	100 m	100 m
Max. viscosity	30.000 mPas	30.000 mPas	50.000 mPas	65.000 mPas	50.000 mPas
Weight	50 kg	50 kg	85 kg	81 kg	83 kg
Art. No.	2351261	2308264	2371027 / 2371028	2371029	2332184 / 2332187
Categorie	DPPS	DPFSF	DPHC	DPHC	DPHC
Material					
Recommended intensity					

	HEAVYCOAT 950 G	HEAVYCOAT 970 E / E SSP	HEAVYCOAT 970 G / G SSP	PLASTCOAT HP 30
Product image (may differ)				
Spraying method				
Technology				
Drive				
Voltage	230 V / 50 Hz	400 V / 50 Hz	400 V / 50 Hz	230 V / 50 Hz
Motor output	4.1 kW	5.5 kW	6 kW	2.3 kW
Max. operating pressure	250 bar, 25 MPa	250 bar, 25 MPa	250 bar, 25 MPa	120 bar, 12 MPa
Max. delivery rate	8 l/min	10,3 l/min	12 l/min	> 10 kg/min
Max. nozzle size	0.052"	0.056"	0.056"	0.055"
Recommended max. hose length	100 m	100 m	100 m	22,5 m
Max. viscosity	50.000 mPas	65.000 mPas	65.000 mPas	-
Weight	76 kg	100 kg	88 kg	72 kg
Art. No.	2332186	2332191 / 2332193	2332192 / 2332194	2388301
Categorie	DPHC	DPHC	DPHC	DPPC
Material				
Recommended intensity				

Water and solvent-based lacquers, lacquer paints, oils, separating agents

Synthetic resin varnishes, PVC lacquers, 2K lacquers

Primers, fillers

Fire protection, rust protection paints

Emulsion and latex paints, adhesives, sealants

Exterior paints, roof coatings, floor coatings, textured paint

Structural waterproofing, bituminous coatings













Filler

Plaster

Residential

Large residential

Commercial

	PLASTCOAT 1030 E	PLASTMAX
Product image (may differ)		
Spraying method		
Technology		
Drive		
Voltage	230 V / 50 Hz	230 V / 50 Hz
Motor output	2.2 kW	3.2 kW
Max. operating pressure	40 bar, 4 MPa	40 bar, 4 MPa
Max. delivery rate	15 l/min	15 l/min
Max. nozzle size	-	-
Recommended max. hose length	40 m	30 m
Max. viscosity	-	-
Weight	59 kg	178 kg
Art. No.	2361588	2361587
Categorie	DPPC	DPPC
Max. grain size	K6 mm	K6 mm
Material		
Recommended intensity		

 Water and solvent-based lacquers, lacquer paints, oils, separating agents

 Fire protection, rust protection paints

 Structural waterproofing, bituminous coatings

 Residential

 Synthetic resin varnishes, PVC lacquers, 2K lacquers

 Emulsion and latex paints, adhesives, sealants

 Filler







 Large residential















 Primers, fillers

 Exterior paints, roof coatings, floor coatings, textured paint

 Plaster

 Commercial

	TEMPSPRAY H 126 BASIC UNIT	TEMPSPRAY H 126 SPRAYPACK
Product image (may differ)		
Spraying method	-	
Technology		
Drive		
Voltage	230 V / 50 Hz	230 V / 50 Hz
Heater power	0.6 kW	0.6 kW
Max. operating pressure	250 bar, 25 MPa	250 bar, 25 MPa
Temperature control	20 – 60 °C	20 – 60 °C
Recommended max. hose length	10 m	10 m
Max. Viscosity	5.000 mPas	5.000 mPas
Weight	3.2 kg	-
Power connection cable	4 m	4 m
Art. No.	2311659	2311852
Categorie	DPTS	DPTS









	TEMPSPRAY H 226 BASIC UNIT	TEMPSPRAY H 226 SPRAYPACK	TEMPSPRAY H 326 BASIC UNIT	TEMPSPRAY H 326 SPRAYPACK
Product image (may differ)				
Spraying method	-		-	
Technology				
Drive				
Voltage	230 V / 50 Hz	230 V / 50 Hz	230 V / 50 Hz	230 V / 50 Hz
Heater power	1.3 kW	1.3 kW	1.1 kW	1.1 kW
Max. operating pressure	250 bar, 25 MPa	250 bar, 25 MPa	250 bar, 25 MPa	250 bar, 25 MPa
Temperature control	20 – 60 °C	20 – 60 °C	20 – 60 °C	20 – 60 °C
Recommended max. hose length	15 m	15 m	30 m	30 m
Max. Viscosity	25.000 mPas	25.000 mPas	25.000 mPas	25.000 mPas
Weight	18 kg	-	23 kg	-
Power connection cable	6 m	6 m	6 m	6 m
Art. No.	2311660	2311853	2311661	2311854
Categorie	DPTS	DPTS	DPTS	DPTS

# NOZZLES

## The heart of the spraying process

Across all technologies – Airless, AirCoat, plaster spraying with worm pumps, HVLP or XVL P – nozzles and air caps play a decisive role in surface quality. In addition to the actual pump, they are the true heart of the spraying process. This is where the material is atomised and where the fineness of the droplet formation in the spray pattern is determined. The nozzle size also determines the quantity of material forced through the bore. Top-quality nozzles are a prerequisite for premium surface finishes in line with your professional standards.



	Water and solvent-based lacquers, lacquer paints, oils, separating agents		Synthetic resin lacquers, PVC lacquers, 2K lacquers		Primers, fillers
	Fire protection, rust protection paints		Emulsion and latex paints, adhesives, sealants		Exterior paints, roof coatings, floor coatings
	Structural waterproofing, bituminous coatings		Filler		Plaster



## AIRLESS TRADETIP 3 NOZZLES – PERFECT AND DURABLE

Art. no. 553xxx The yellow standard nozzle covers a wide spectrum of applications using primers, enamels and lacquers.

Jet width (mm)*	Orifice size (inch)																									
	0,007	0,009	0,011	0,013	0,015	0,017	0,019	0,021	0,023	0,025	0,027	0,029	0,031	0,033	0,035	0,039	0,043	0,045	0,051	0,052	0,055	0,061	0,063	0,065	0,067	
100	107	109	111	113	115	117																				
120	207	209	211	213	215	217	219	221	223	225	227	229	231	233	235		243			252		261	263		267	
150	307	309	311	313	315	317	319	321	323	325	327	329	331	333	335											
190	407	409	411	413	415	417	419	421	423	425	427	429	431	433	435	439	443	445	451		455	461	463		467	
225		509	511	513	515	517	519	521	523	525	527	529	531	533	535	539	543	545	551		555	561		565		
270		609	611	613	615	617	619	621	623	625	627	629	631	633	635	639	643		651		655	661		665		
300					715	717	719	721	723	725			731		735											
330				813	815	817	819	821	823	825	827		831													
385							919																			
Flow rate (l/min)**	0,19	0,34	0,45	0,68	0,91	1,17	1,47	1,78	2,15	2,53	2,95	3,44	3,89	4,42	4,99	6,20	7,52	8,24	10,58							
Filter	red			yellow			white						green													



## HEA PROTIP NOZZLES – UP TO 55 % LESS OVERSPRAY

Art. no. 554xxx The new WAGNER HEA ProTip airless nozzle provides a perfect surface finish at reduced spraying pressure. Compared to standard airless technology the spray pattern is gently feathered and free from edge strips.

Jet width (mm)*	Orifice size (inch)						Spray angle in °
	0,011	0,013	0,015	0,017	0,019	0,021	
120	211	213					20
150	311	313					30
190	411	413	415	417		421	40
225			515	517	519	521	50
270			615	617	619	621	60
Flow rate (l/min)**	0,45	0,68	0,91	1,17	1,47	1,78	
Filter	red		yellow		white		



## AIRLESS TRADETIP 3 FINEFINISH

Art. no. 554xxx Top paint nozzle with optimised third-generation properties. With double special core for ultra-fine droplet formation and exceptionally high-quality surfaces, even in low pressure ranges. FineFinish nozzles are coloured purple.

Jet width (mm)*	Orifice size (inch)				Spray angle in °
	0,008	0,010	0,012	0,014	
120	208	210	212	214	20
150	308	310	312	314	30
190	408	410	412	414	40
225		510	512	514	50
Flow rate (l/min)**	0,26	0,42	0,6	0,79	
Filter	red				

\* Spray width (mm) at approx. 30 cm distance from the object and 100 bar pressure, with synthetic resin paint, 20 DIN seconds  
 \*\* Measured with water at 120 bar pressure

## 2SPEEDTIP 2 nozzles in one

WAGNER's innovative reversible nozzle combines two nozzle cores in a single nozzle. Simply rotate to select the appropriate nozzle size. This allows optimal adjustment to the surface to be coated and brings an additional timesaving benefit. The colour identification on the nozzle also indicates the matching gun filter insert.

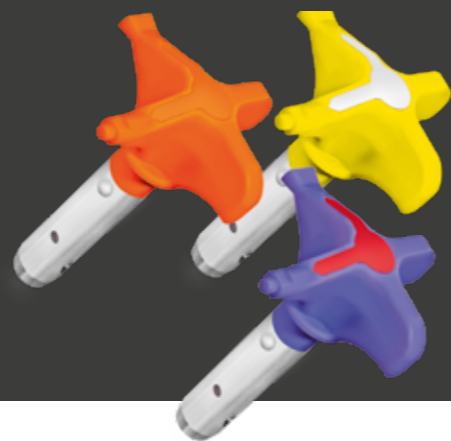

Art. no. 271xxx

## AIRLESS 2SPEEDTIP NOZZLES – TWO NOZZLES IN ONE

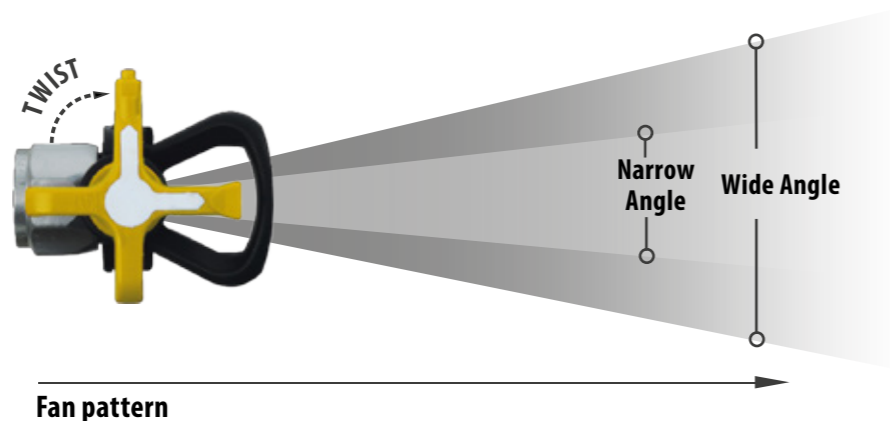

Spray pattern (mm)*	Orifice size (inch)												Spray angle in °
	0.008; 0.010	0.010; 0.012	0.012; 0.014	0.011; 0.015	0.011; 0.019	0.015; 0.021	0.015; 0.023	0.017; 0.027	0.025; 0.029	0.027; 0.035	0.039; 0.043	0.043; 0.052	
100; 190				062	045	046	047	048					10; 40
120; 225	042	043	044										20; 50
120; 225									049	050	051		20; 60
120; 270									064				
Filter	red			white									

Suggestion: 2SpeedTip nozzle have to be used with tip holder (289390 (G)) in combination with 2SpeedTip tip holder (271065).

Water and solvent-based lacquers, lacquer paints, oils, separating agents

Structural waterproofing, bituminous coatings

Synthetic resin varnishes, PVC lacquers, 2K lacquers

Filler

Primers, fillers

Plaster



Art. no. 1009xxx

## AIRLESS TWINTIP NOZZLES – EONE NOZZLE, TWO NOZZLE ORAFICES

For fog-free spraying: NESPRI TwinTip nozzles have two nozzle orafices one directly above the other – For a perfect spray pattern with high material throughput even in low pressure ranges. Guaranteed mist-free thanks to the use of the NESPRI spray device in combination with the NESPRI TwinTip and NESPRI paints from Caparol. Different sizes are available to adapt ideally to the relevant environment.

Spray pattern (mm)*	Orifice size (inch)				Spray angle in °
	0.013	0.021	0.023	0.027	
100		215			20
110	213 ***				20
130		316	317	319	30
Filter	white				

\*\*\* Mono nozzle for trimming jobs



Art. no. 90xxx

## AIRLESS STANDARD FAN NOZZLES

Airless standard flat jet nozzle are especially suitable for painting applications, but can be used also for high viscosity materials. They are ideal for the fast processing of large quantities of material. The high-quality nozzles are robust and suitable for all common Airless guns.

Suggestion: Airless standard flat jet nozzles have to be equipped with touch protection (97294) and seal (43052) for flat jet nozzles.

Spray pattern (mm)*	Orifice size (inch)																
	0.007	0.009	0.011	0.013	0.015	0.017	0.019	0.021	0.023	0.025	0.027	0.030	0.031	0.035	0.039	0.043	0.051
90			111		115												
100			211	113	215												
120			311	213		217			223	225			231	235			
150		209		313		317	219	221			227					243	
160	407	309			315		319										
190	507	409				417	419	421	423	425							
215		509	411	413	415								431				
225		609	511			517					427		531	435			
250					515			521	523	525	527						
270			611	513	615		519			625	627		631	535		543	552
300				613	715	617	619		623			629		635			
330						717	719	621	723		827						
385				813	815			821	823	825							
400							819										
480																839	
Flow rate (l/min)**	0.19	0.34	0.49	0.68	0.91	1.17	1.47	1.78	2.15	2.53	2.95	3.44	3.89	4.99	6.2	7.52	11.0
Filter	red		red / yellow		yellow		yellow / white		white			green					

Fire protection, rust protection paints

\* Spray width (mm) at approx. 30 cm distance from the object and 10 MPa (100 bar) pressure, with synthetic resin paint, 20 DIN seconds

\*\* Measured with water at 12 MPa (120 bar) pressure

Emulsion and latex paints, adhesives, sealants

Exterior paints, roof coatings, floor coatings, textured paint

# ACCESSORIES – AIRLESS

## AIRLESS GUN VECTOR INFINITY

Vector Infinity with G-thread 1/4", incl. TradeTip 3 nozzle holder, 34.5 MPa (345 bar) with 2-finger trigger and adaptable hand grip 0538085

Small grip, for customization to any hand, for Vector Infinity 0538264

Medium grip, for customization to any hand, for Vector Infinity 0538265

Large grip, for customization to any hand, for Vector Infinity 0538266



Vector Infinity is the PREMIUM gun

## FILLER AIRLESS GUN AG 19 WITH 4-FINGER TRIGGER

AG 19 with G-thread 3/8", 25 MPa (250 bar) 2341127

## HIGH-PRESSURE AIRLESS GUN AG 19 WITH 4-FINGER TRIGGER

AG 19 with G-thread 1/4", 53 MPa (530 bar) 2343778

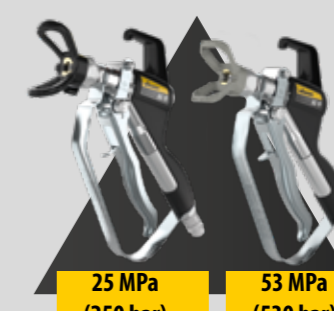

25 MPa  
(250 bar)

53 MPa  
(530 bar)

AG 19 is particularly suitable for highly viscous materials



Vector Grip fits perfectly in the hand and is suitable for heated applications

## AIRLESS PISTOLE VECTOR GRIP

Vector Grip with G-thread 1/4", incl. TradeTip 3 nozzle holder, 25 MPa (250 bar) with 2- and 4-finger trigger and medium-sized grip 0538043

Small grip, for customization to any hand, for Vector Grip 0538228

Medium grip, for customization to any hand, for Vector Grip 0538229

Large grip, for customization to any hand, for Vector Grip 0538230



5 liter hopper - perfect for small volumes with lacquer

## HOPPERS

5 litre hopper, M36x2 341265

5 litre hopper, with TopClean 341268

20 litre hopper, M36x2 341266

Hopper, 5 litre, for ProSpray 3.20, 20, 3.21, 3.25 skid version 704-453

## AIRLESS GUN VECTOR PRO

Vector Pro with G-thread 1/4", incl. TradeTip 3 nozzle holder, 25 MPa (250 bar) with 4-finger trigger 0538040

Vector Pro with G-thread 1/4", incl. TradeTip 3 nozzle holder, 25 MPa (250 bar) with 2-finger trigger 0538041

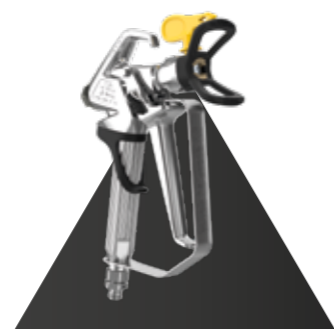

Vector Pro - the entry level spray gun

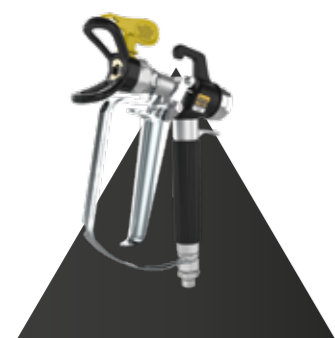

AG 14 is the all-rounder among Airless guns and also sprays high viscosity materials

## AIRLESS GUN AG 14 WITH 4-FINGER TRIGGER

AG 14 with G-thread 1/4", 27 MPa (270 bar), incl. TradeTip 3 nozzle holder 0502081A

## SUCTION SYSTEMS

Container suction system, incl. C-coupling adaptor 0349907

Reduction adaptor B- to C-coupling 9991651

Blanking plug for C coupling 0097305

Container Connector, for HeavyCoat, for direct suction of the material out of the large volume container 2383128

Container Connector, for SF 27/31/33 2371930

Large volume containers (100 l) 2309956

Large volume container, incl. sack support and roller press 2309960

PumpRunner (only for rigid suction system) 2306987



PumpRunner - for clean and easy transportation of the pump

## OTHER ACCESSORIES

Hose reel HR30; M16x1.5; for 30m HD-hose; usable for SF23 Plus / SF 27 / SF 31 341910

Hose reel HR30, 1/4" NPS; for 30m HD-hose, usable for SF 33 2392523

Hose reel HR45, incl. 30 m HP hose DN6, for all diaphragm and piston pumps 341912

Hose reel - perfect hose management for optimum handling



## SPEEDSHIELD

SpeedShield

0538905

No ladders or scaffolding - The Pole-gun extends your workingradius

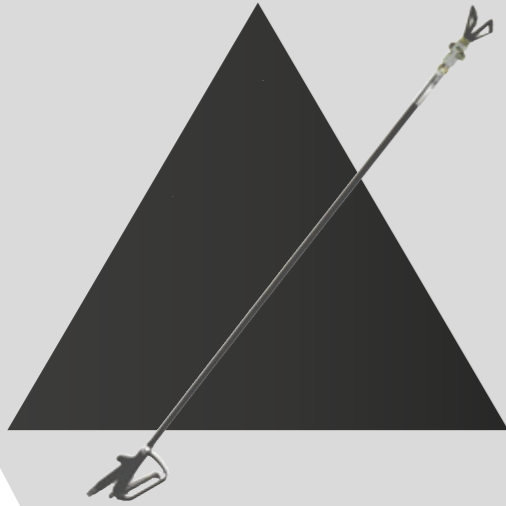

SpeedShield - trimming without masking; delivered without Tip and extension



## POLE GUNS

Pole gun 120 cm, 1/4" nozzle holder, G-thread 7/8" 0296441

Pole gun 200 cm, 1/4" nozzle holder, G-thread 7/8" 0296442

## PAINT ROLLERS

Inline Roller IR 100 incl. HP hose DN4, max. 27 MPa, 7.5m, extension 0.5m, woven plush paint roller, short pile 13 mm and much more 0345010

Innerfeed Roller incl extension (0.9 m) 2420499

SprayRoller Cage incl. extension (0.9 m) 2420496

SprayRoller Frame incl. extension (0.9 m) 2420497

Gun extension incl. extension (0.9 m) 2420538

Airless paint roller - rational coating with paint roller

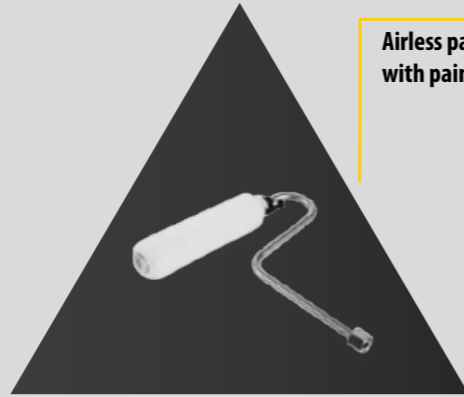

Nozzle extension - for more comfortable working and a wider reach

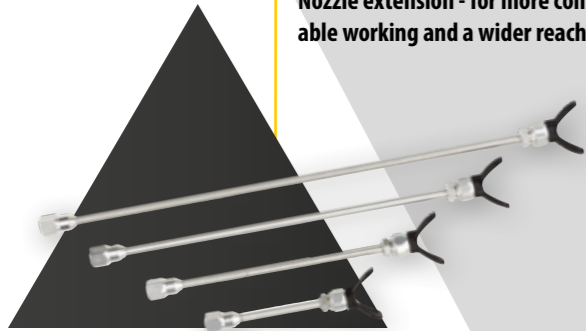

## NOZZLE EXTENSIONS

Nozzle extension, 15 cm, G-thread 0556074

Nozzle extension, 30 cm, G-thread 0556075

Nozzle extension, 45 cm, G-thread 0556076

Nozzle extension, 60 cm, G-thread 0556077

## CLEANING AND STORAGE

TipClean, container incl. special cleaner; 200 ml 2400214

EasyClean Cleaning and corrosion protection 1 L 2412656

EasyGlide, special oil, 118 ml 508619

TipClean - easy cleaning and storage of your airless nozzles



## NOTES

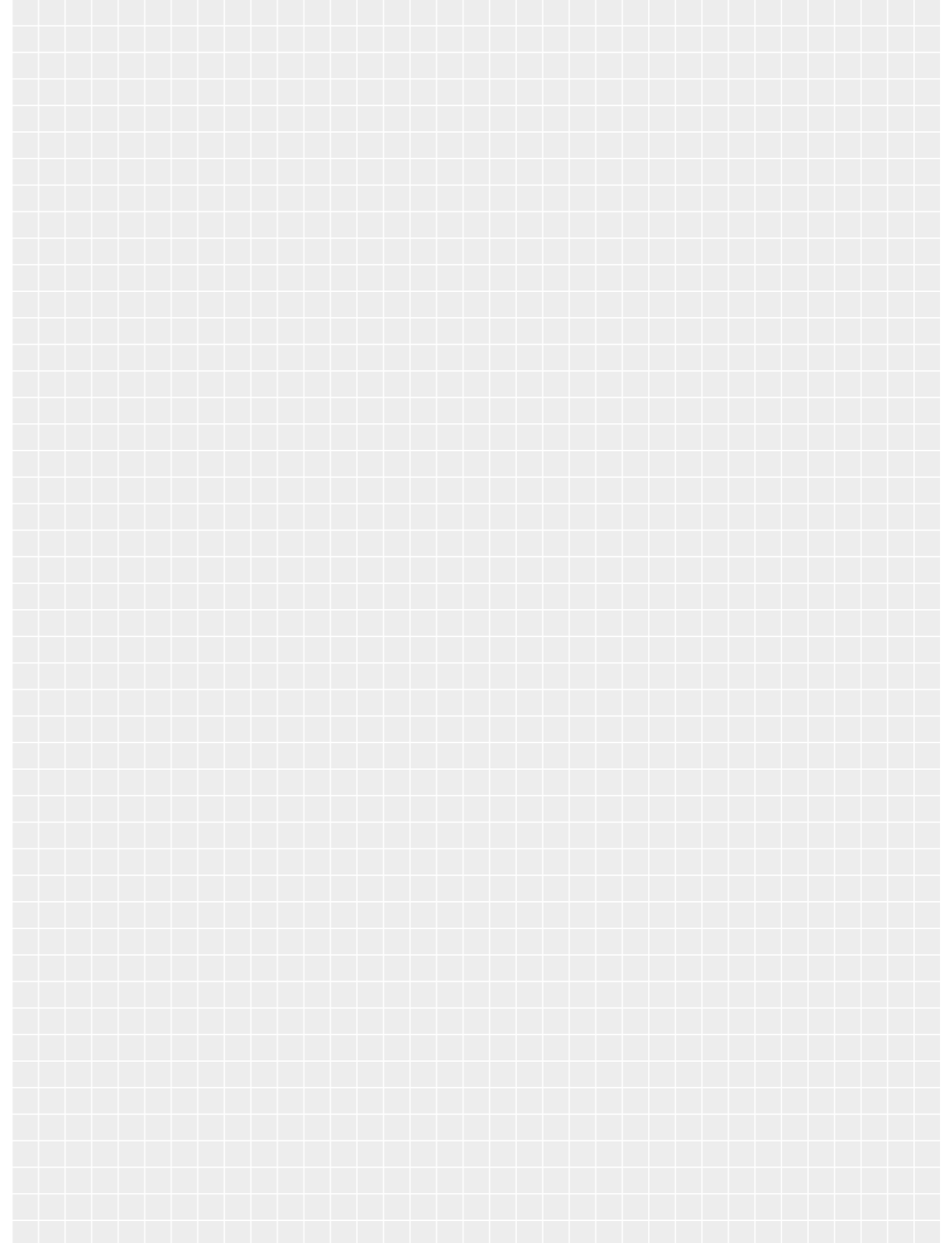

# AIRCOAT for wood and metal craft

Brilliant surfaces with AirCoat: The soft atomization guarantees brilliant surfaces and thus ensures perfect painting results.



Art. no. 379xxx

## AIRCOAT NOZZLES ACF 3000

The dome-shaped geometry and high-tech honing methods during manufacture ensure extremely fine atomisation with low energy consumption (material pressure). For a long service life and low wear and tear, the nozzle is made from resistant hard metal. The WAGNER AirCoat nozzle ensures brilliant surface finishes: An even spray pattern and extremely gentle graduated borders are guaranteed. This applies to both small and large quantities of atomised air.

		Orifice size (inch)									
		0.007	0.009	0.011	0.013	0.015	0.017	0.019	0.021	0.023	
Spray pattern (mm)*	55	107		111	113	115					10
	100	207	209	211	213	215	217	219	221		20
	145	407	309	311	313	315	317	319			30
	195		409	411	413	415	417	419	421	423	40
	250		509	511	513	515	517	519	521		50
	300		609	611	613	615	617	619	621	623	60
	400			811	813	815	817	819	821	823	80
Filter		red		red / yellow	yellow	yellow / white	white				

Spray anglein °

## AIRCOAT PRE-ATOMISATION NOZZLES ACF 3000 PLUS



Art. no. 321xxx

AirCoat pre-atomisation nozzles provide extra fine atomisation even with low inlet air pressure. This is especially important for processing water- or solvent-based paints. Using a pre-atomisation nozzle allows you to work with less material and air quantity. There is significantly less overspray and material consumption decreases. Compared to the standard AirCoat nozzle the material is pre-atomised directly at the outer edge of the nozzle. The result: an especially even and soft spray pattern.

		Orifice size (inch)								
		0.008	0.010	0.012	0.014	0.016	0.018	0.020	0.022	
Spray pattern (mm)*	100	208	210	212	214	216	218			20
	145	308	310	312	314	316	318	320		30
	195	408	410	412	414	416	418	420	422	40
	250	508	510	512	514	516	518			50
	300		610	612	614	616	618	620	622	60
Filter		red	red / yellow		yellow	yellow / white	white			







Spray anglein °

\* Spray width (mm) at approx. 30 cm distance from the object and 10 MPa (100 bar) pressure, with synthetic resin paint, 20 DIN seconds

\*\* Measured with water at 12 MPa (120 bar) pressure

## AIRCOAT MATERIALS

Only for Aircoat Tips,  
ACF 3000 & ACF 3000 Plus

	Water and solvent-based lacquers, lacquer paints, oils, separating agents		Synthetic resin varnishes, PVC lacquers, 2K lacquers		Primers, fillers
	Fillers, anti-corrosive paints		Fire protection, rust protection paints		Corrosion protection

### AIRCOAT GUN AC 4500

AC 4500 Professional, incl. blue air cap and nozzle holder	2368269
AC 4500 Professional, incl. green air cap and nozzle holder	2368270
AC 4500 Professional, incl. red air cap and nozzle holder	2368271

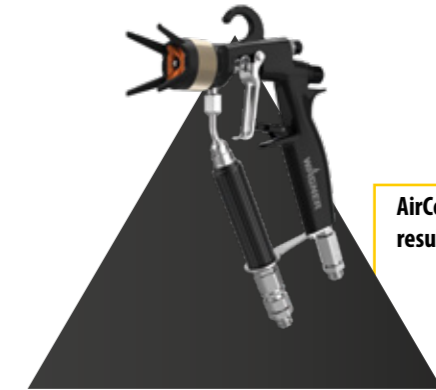

AirCoat AC 4500 for perfect surface results.

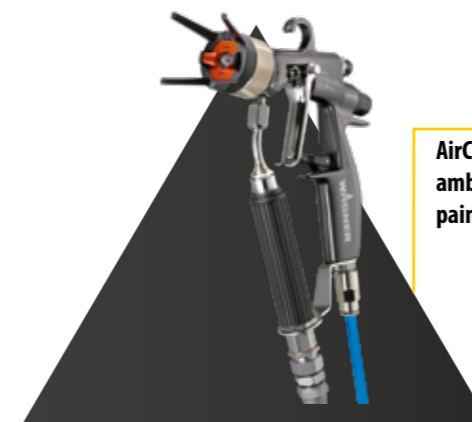

AirCoat AC 4600 for ambitious, comfortable painting work.

### AIRCOAT GUN AC 4600

AC 4600 Professional, incl. blue air cap and holder	394156
AC 4600 Professional, incl. green air cap and holder	394158
AC 4600 Professional, incl. red air cap and holder	394157

### AIRCOAT GUN ACCESSORIES

Air cap blue, for water-based materials (01)	394911
Air cap red, for solvent-based materials (02)	394910
Air cap green, for water-based materials and solvent-based materials (03)	394912
Union nut, complete (04)	394921

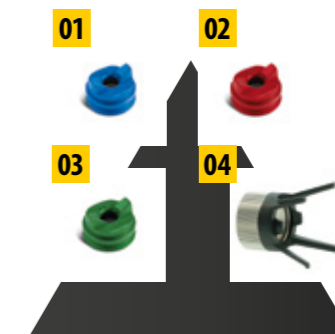

Various air caps for different applications



## ACCESSORIES – PLASTCOAT

### CONTINUOUS MIXER

PlastMix 15	2348669
-------------	---------

PlastGuard longlasting - to protect the device and for optimum storage



Continuous mixer for dry materials

### ACCESSORIES FOR PLASTCOAT HP 30

Pump protection PlastGuard 1 L	2399959
PlastGuard longlasting pump protector	2399960
PlastCoat HP 30 emulsion set	2400684



### CLEANING AND STORAGE

Brush with handle and cap	9100095
Bottle brush for cleaning interior of outlet unit and spraying lance	0342329
Cleaning adapter M27GK	0342241
Cleaning brush, 280 to 420 mm long	0348959
Cleaning ball DN16	2402355
Cleaning ball DN19	342330



Cleaning balls - for cleaning out hoses and avoiding nozzle blockages

### SUPPORT TABLE INCL. ROLLER PRESS

Support table cpl. for PC 830	2318389
Support table cpl. for PC HP 30	2389048

Bag squeezing table - for the convenient processing of bagged goods



## ACCESSORIES – HVLP / XVLP

### XVLP FINISHCONTROL SPRAY ATTACHMENT

FineSpray spray attachment	2321877
StandardSpray spray attachment	2321879
WallSpray spray attachment	2321880



FineSpray spray attachment XVLP - for glazes and lacquers

HVLP Split gun - 600 ml flow cup - for wood & metal paints



### HVLP GUNS

Gravity feed cup, for FineCoat Split Gun, 600 ml	0524053
FineCoat Split Gun; suction cup; 1000 ml	0524028
FineCoat Pistole, Pressure cup 1 L, incl. nozzle kit no.4	0524045

### NOZZLE SET FOR FINECOAT GUN

	Art. Nr.
Nozzle set, for FineCoat gun, 1, Ø 0.5 mm	276155
Nozzle set, for FineCoat gun, 2; Ø 0,8 mm	276254
Nozzle set, for FineCoat gun, 3; Ø 1,3 mm	276227
Nozzle set, for FineCoat gun, 4; Ø 1,8 mm	276228
Nozzle set, for FineCoat gun, 5; Ø 2,2 mm	276229
Nozzle set, for FineCoat gun, 6; Ø 2,5 mm	276245
Nozzle set, for FineCoat gun, 7; Ø 2,7 mm	524211

Nozzle set - for different materials

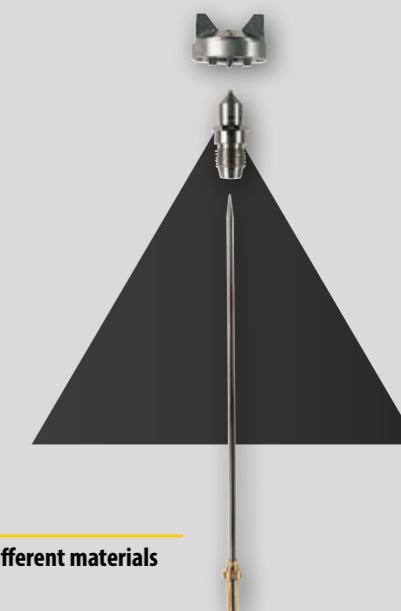

### NOZZLE SET FOR FINECOAT SPLIT GUN

Nozzle set, for FineCoat Split Gun, no. 2, Ø 0.8 mm	0529209
Nozzle set, for FineCoat Split Gun, no. 3, Ø 1.3 mm	0529210
Nozzle set, for FineCoat Split Gun, no. 4, Ø 1.8 mm	0529211
Nozzle set, for FineCoat Split Gun, no. 5, Ø 2.2 mm	0529212
Nozzle set, for FineCoat Split Gun, no. 6, Ø 2.4 mm	0529213
Nozzle set, for FineCoat Split Gun, no. 7, Ø 2.6 mm	0529214

NOTES

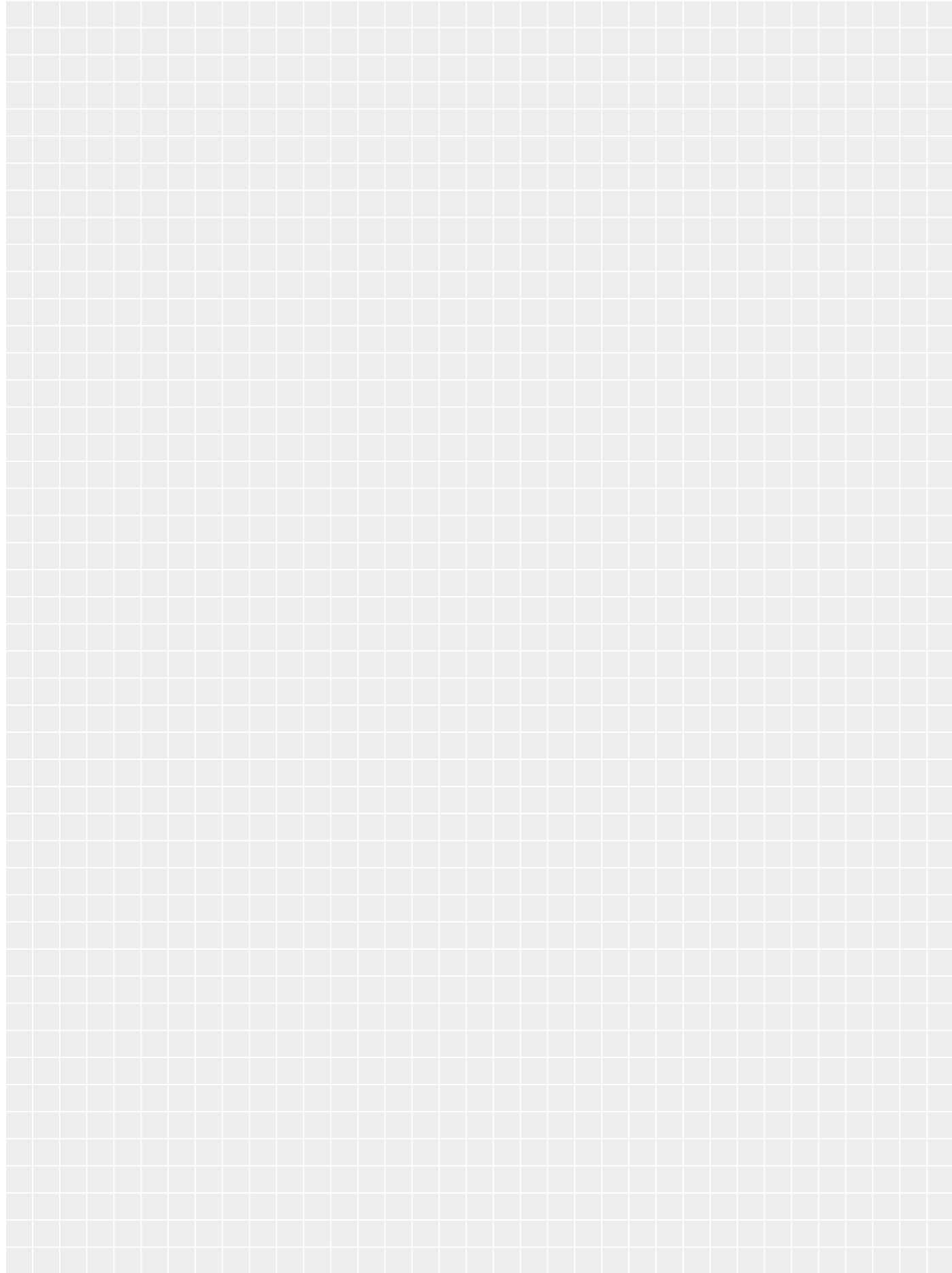

**BE UNSTOPPABLE!**



# BE UNSTOPPABLE!

**VISIT US AT**

