

CETOP SERİSİ BAĞLANTI ELEMANLARI
CETOP SERIES MOUNTING ELEMENTS

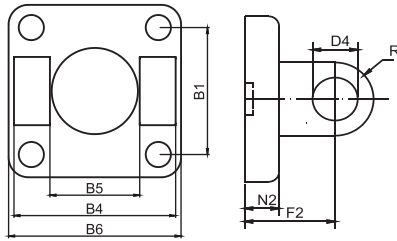

EB:EKLEM BAĞLANTI SWIVEL FLANGE

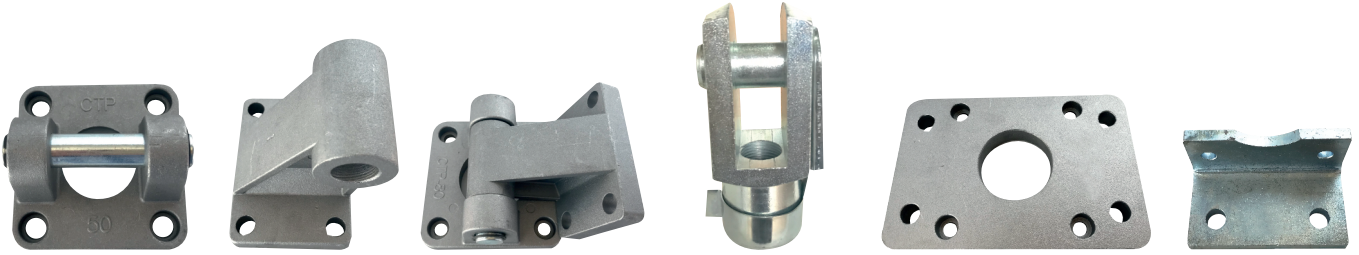
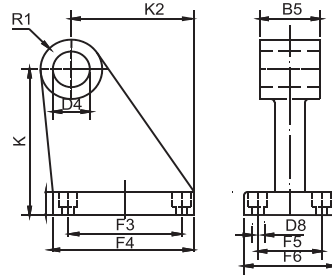

YB:YER BAĞLANTI / CLEVIS FOOT MOUNTING

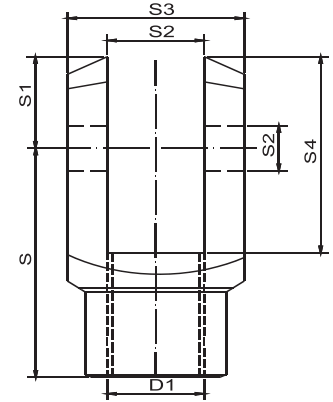

ÇB:ÇATAL BAĞLANTI / ROD CLEVIS

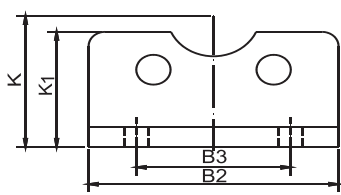

AB:AYAK BAĞLANTI / AB:FOOT MOUNTING

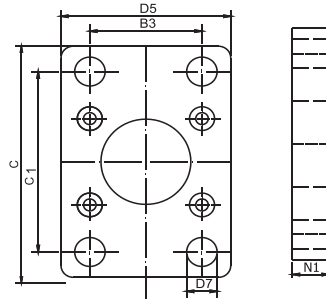
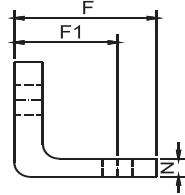

FB:FLANŞ BAĞLANTI / FLANGE MOUNTING

Silindir Ölçüsü	B1	B2	B3	B4	B5	B6	C	C1	D4	D8	F	F1	F2	F3	F4	F5	F6	K	K1
Ø32	32.5	45	32	45	25	53	90	75	10	6	32	26	22	38	31	18	51	32	26
Ø40	39.6	55	36	50	28	58	115	94	12	6	35	25	25	41	35	22	56	40	31
Ø50	48	65	45	60	30	70	125	106	12	8	43	32	27	50	45	30	65	45	32
Ø63	59.3	80	50	70	40	80	145	122	16	8	46	33	35	52	50	35	66	49	35
Ø80	70.7	96	63	90	50	100	173	145	16	10	60	42	38	66	60	40	85	69	53
Ø100	93.4	125	75	110	60	125	210	175	20	10	60	47	43	76	70	50	96	74	57
Ø125	106	140	90	130	70	140	220	180	25	11	70	50	50	94	90	60	124	90	80

CETOP SERİSİ BAĞLANTI ELEMANLARI
CETOP SERIES MOUNTING ELEMENTS

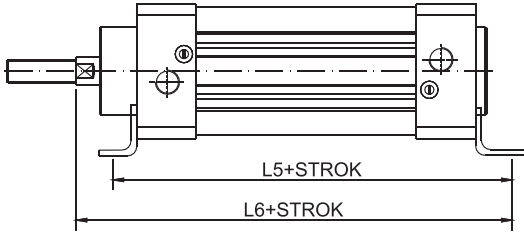
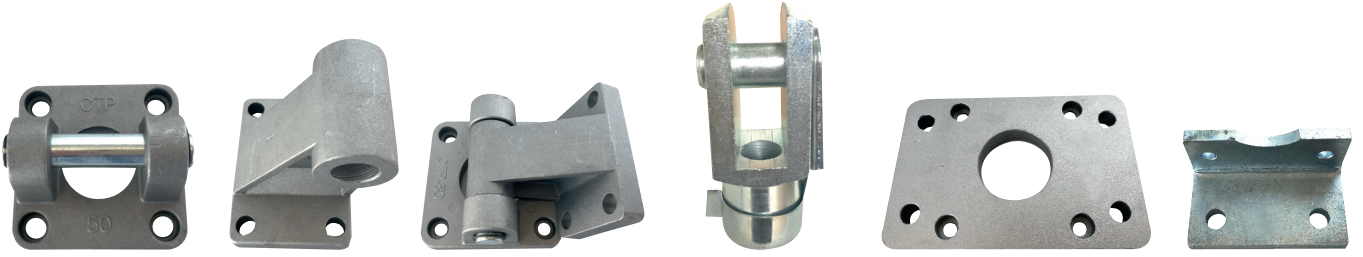

AYAK BAĞLANTI / FOOT MOUNTING

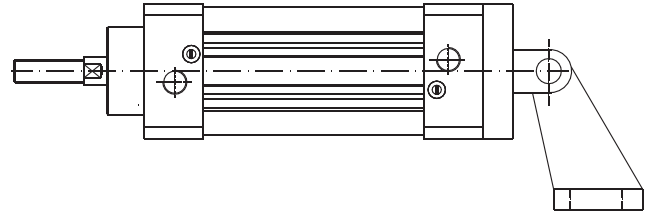

EKLEM YER BAĞLANTI / SWIVEL FLANGE with FOOT MOUNTING

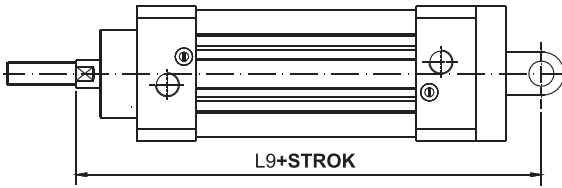

EKLEM BAĞLANTI / SWIVEL FLANGE

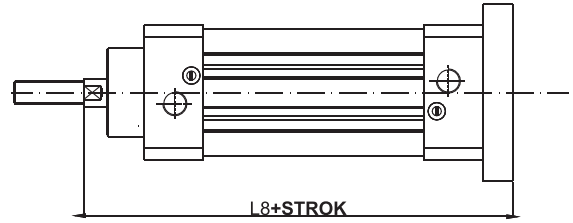

ARKA FLANŞ BAĞLANTI / REAR FLANGE MOUNTING

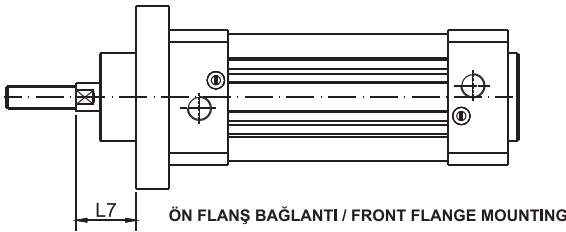

ÖN FLANŞ BAĞLANTI / FRONT FLANGE MOUNTING

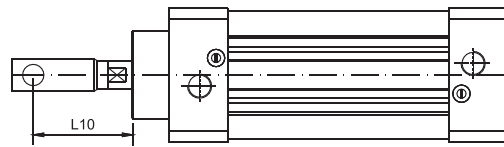

ÇATAL BAĞLANTI / ROD CLEVIS

Silindir Ölçüsü	K2	L5	L6	L7	L8	L9	L10	N	N1	N2	R	R1	S	S1	S2	S3	S4
Ø32	27	144	145	14,5	132	142	55	4	12	8	10	10	40	12	10	20	32
Ø40	30	155	160	18	147	160	65	5	12	9	13	11	47	14	12	24	37
Ø50	40	170	175	22	158	170	85	6	15	10	16	13	65	19	16	32	52
Ø63	44	181	188	25	170	190	85	6	15	12	18	15	65	19	16	32	52
Ø80	50	208	214	30	190	210	103	8	18	14	18	15	81	24	20	40	65
Ø100	60	223	231	33	206	230	103	8	20	16	23	19	81	24	20	40	65
Ø125	80	250	271	46	246	271	135	10	25	20	25	22	100	30	25	50	80