

SS2/LN-0E

cylindrical photosensors



Micro Detectors

Italian Sensors Technology



Indicative image

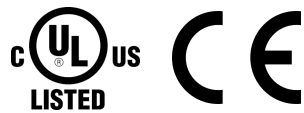
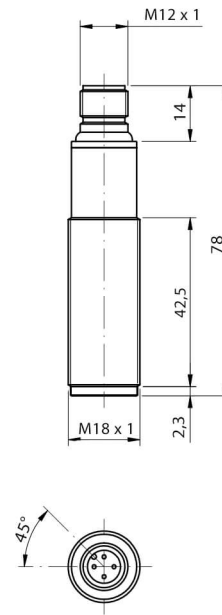

Detection properties

Nominal sensing distance	100mm
Thermal drift of Sr	≤10% Sr
Repeat Accuracy	5%
Sensitivity adjustment	No

Application

Function Principle	Diffuse reflection (short distance, ≤200mm)
Notes	white target 90% Kodak 100x100mm
Optic position	Axial

Outputs

Output type	NPN
Output Function	LO

Switching frequency	250Hz
---------------------	-------

Electrical data

Operating Voltage	10...30Vdc
-------------------	------------

No-Load supply current	≤30mA
------------------------	-------

Load current	≤100mA
--------------	--------

Leakage current	≤10μA
-----------------	-------

Output voltage drop	1,2V max. IL =100 mA
---------------------	----------------------

Max ripple content	10%
--------------------	-----

LED indicators	Yellow (output state)
----------------	-----------------------

Time delay before availability	≤200ms
--------------------------------	--------

Short-circuit protection	Yes
--------------------------	-----

Reverse Polarity Protection	Yes
-----------------------------	-----

Emission	Infrared (880 nm)
----------	-------------------

Interference to external light	3000lux (incandescent lamp), 10000lux (sunlight)
--------------------------------	--

Impulsive Overvoltage Protection	Yes
----------------------------------	-----

Mechanical data

Dimensions	M18 x 1 / L =78mm
------------	-------------------

Weight	30g
--------	-----

Housing Material	PBT / PC plug
------------------	---------------

Connections	M12 plug
-------------	----------

Active Head Material	PMMA
----------------------	------

Tightening torque	1Nm
-------------------	-----

Operating temperature	- 25°C...+ 70° C (Without freeze)
-----------------------	-----------------------------------

Diameter/Dimension	M18
--------------------	-----

Test/Approvals

Approvals	CE, cULus
-----------	-----------

EMC compatibility	EN 60947-5-2
-------------------	--------------

Shocks and vibrations	Vibration IEC 60068-2-6 / Shock IEC 60068-2-27
-----------------------	--

Degree of protection	IP67
----------------------	------

Accessories

Supplied Accessories	nuts M18 x 1
----------------------	--------------

ELECTRICAL DIAGRAMS OF THE CONNECTIONS

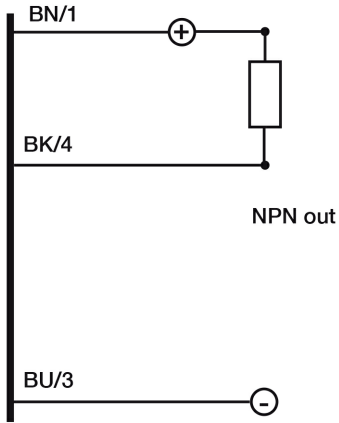

CONNECTOR

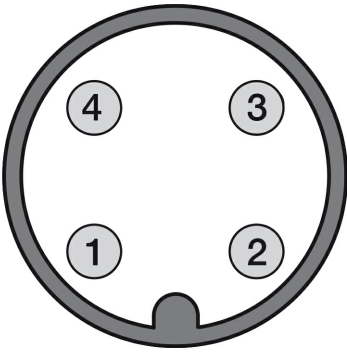

RESPONSE CURVES

Dimensione Spot

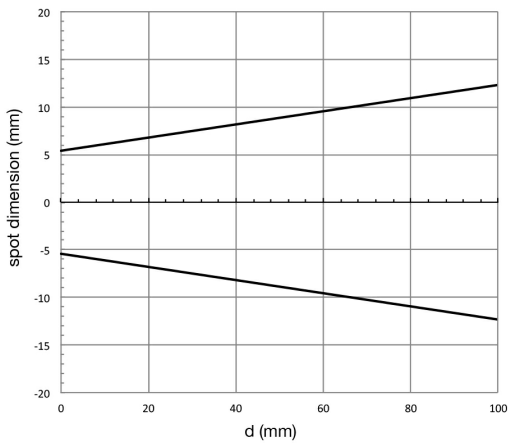

Disassamento Parallelo

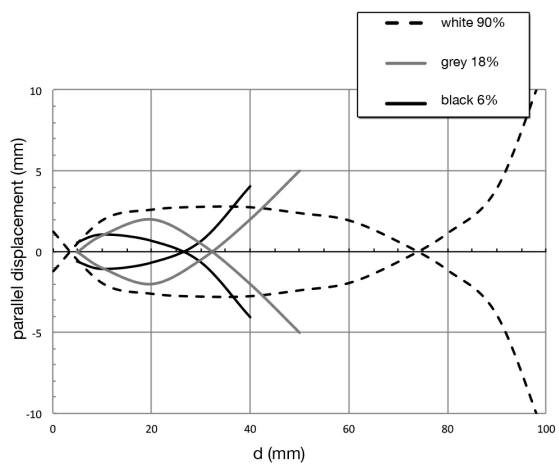

Eccesso di Guadagno

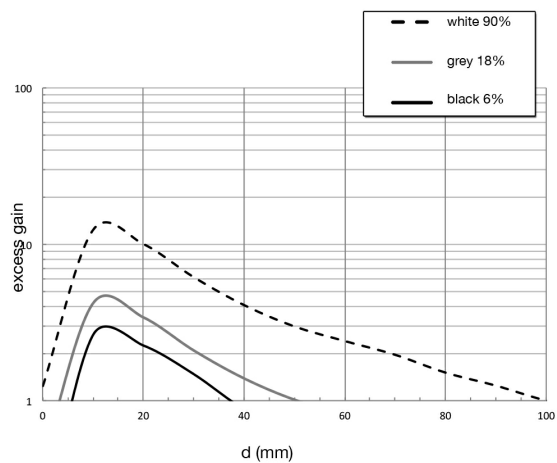

M.D.Micro Detectors S.p.A.

Strada S.Caterina, 235

41122 Modena (MO)

Tel. 059 420411

Fax 059 253973

E-mail info@microdetectors.com

date of printing

20/11/2020 14:17:31