

# AM1/CP-1H

cylindrical inductive



Micro Detectors

Italian Sensors Technology



Indicative image

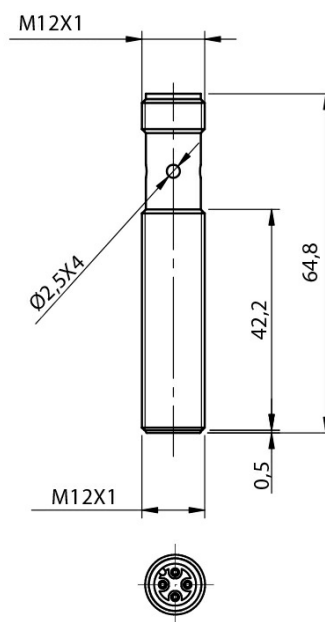

## Detection properties

Nominal sensing distance	2mm
Operanting distance	0...1,6mm
Standard target	12x12mm FE360
Correction Factor	copper: 0,22 / aluminium: 0,31 / brass: 0,41 / stainless steel: 0,77
Thermal drift of Sr	< 10%
Repeat Accuracy	5% (UB 24V Ta=23°C ±5°C)
Hysteresis	1 ... 20%

## Outputs

Output type	PNP
Output Function	NC
Switching frequency	2kHz

## Electrical data

Operating Voltage	10...30Vdc
No-Load supply current	≤ 10mA
Load current	≤ 200mA
Leakage current	≤ 10µA
Output voltage drop	≤ 1,8V @200mA

Max ripple content	≤10%
LED indicators	Yellow LED output state
Time delay before availability	≤ 50ms
Short-circuit protection	Yes (auto-reset)
Reverse Polarity Protection	Yes
Protection against inductive loads	Yes

## Mechanical data

Mounting	Shielded
Dimensions	M12 x 1 / L = 64,8mm
Weight	30g
Housing Material	Nickel-plated brass
Connections	M12 Plug
Active Head Material	PBT
Tightening torque	10Nm
Operating temperature	-25°C...+70°C
Diameter/Dimension	M12

## Test/Approvals

Approvals	CE UR
EMC compatibility	IEC 60947-5-2
Shocks and vibrations	Vibration IEC 60068-2-6 / Shock IEC 60068-2-27
Degree of protection	IP67

## Accessories

Supplied Accessories	2 nuts M12x1
----------------------	--------------

---

# ELECTRICAL DIAGRAMS OF THE CONNECTIONS

---

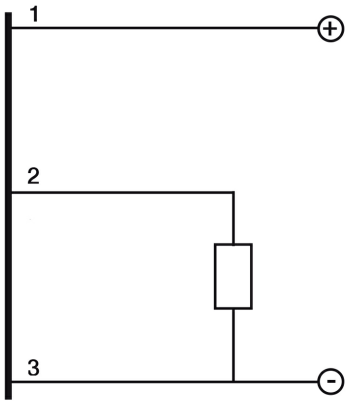

## CONNECTOR

---



## INSTALLATION

---

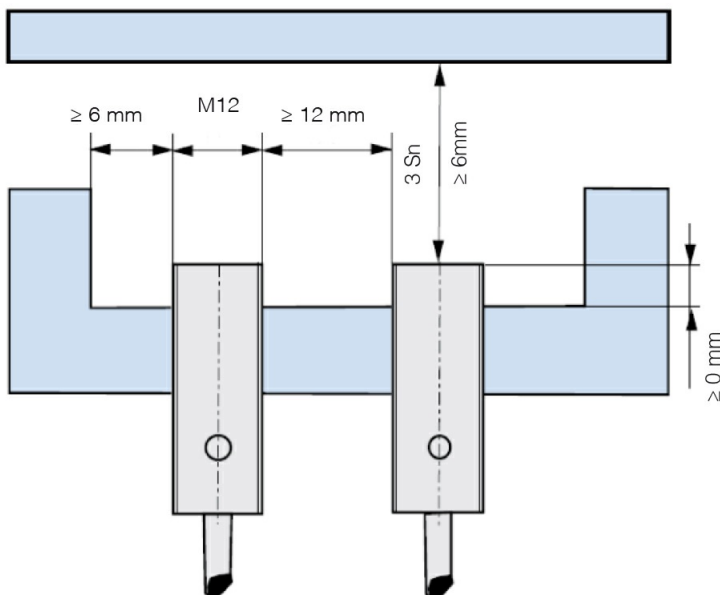

# RESPONSE CURVES

---

## Disassamento Parallelo

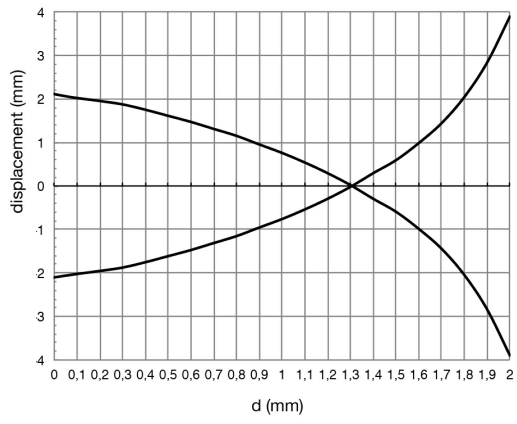

---

**M.D. Micro Detectors S.p.A.**

Strada S. Caterina, 235  
41122 Modena (MO)  
Tel. 059 420411  
Fax 059 253973  
E-mail [info@microdetectors.com](mailto:info@microdetectors.com)

**date of printing**

19/11/2020 15:09:50