

## INDOOR UNIT

No. OBH750

# SERVICE MANUAL

### Models

**MSZ-DM25VA** - E1, ER1

**MSZ-DM35VA** - E1, ER1

Outdoor unit service manual  
MUZ-DM·VA Series (OBH751)  
MXZ-DM·VA Series (OBH739)

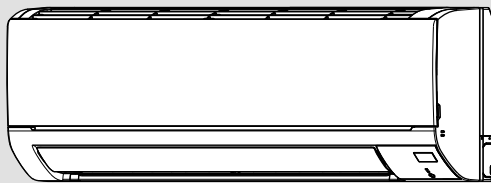

**MSZ-DM25VA  
MSZ-DM35VA**



### CONTENTS

1. TECHNICAL CHANGES .....	3
2. PART NAMES AND FUNCTIONS .....	4
3. SPECIFICATION .....	5
4. NOISE CRITERIA CURVES .....	6
5. OUTLINES AND DIMENSIONS .....	7
6. WIRING DIAGRAM .....	8
7. REFRIGERANT SYSTEM DIAGRAM .....	9
8. SERVICE FUNCTIONS .....	10
9. MICROPROCESSOR CONTROL .....	12
10. TROUBLESHOOTING .....	16
11. DISASSEMBLY INSTRUCTIONS .....	28

**PARTS CATALOG (OBB750)**

**NOTE:**

RoHS compliant products have  
<G> mark on the spec name plate.

## **Use the specified refrigerant only**

### **Never use any refrigerant other than that specified.**

Doing so may cause a burst, an explosion, or fire when the unit is being used, serviced, or disposed of.

Correct refrigerant is specified in the manuals and on the spec labels provided with our products.

We will not be held responsible for mechanical failure, system malfunction, unit breakdown or accidents caused by failure to follow the instructions.

### **<Preparation before the repair service>**

- Prepare the proper tools.
- Prepare the proper protectors.
- Provide adequate ventilation.
- After stopping the operation of the air conditioner, turn off the power-supply breaker and remove the power plug.
- Discharge the capacitor before the work involving the electric parts.

### **<Precautions during the repair service>**

- Do not perform the work involving the electric parts with wet hands.
- Do not pour water into the electric parts.
- Do not touch the refrigerant.
- Do not touch the hot or cold areas in the refrigeration cycle.
- When the repair or the inspection of the circuit needs to be done without turning off the power, exercise great caution not to touch the live parts.

**MSZ-DM25VA** -<sup>E1</sup>, <sup>ER1</sup>

**MSZ-DM35VA** -<sup>E1</sup>, <sup>ER1</sup>

1. New model

## 2

# PART NAMES AND FUNCTIONS

MSZ-DM25VA MSZ-DM35VA

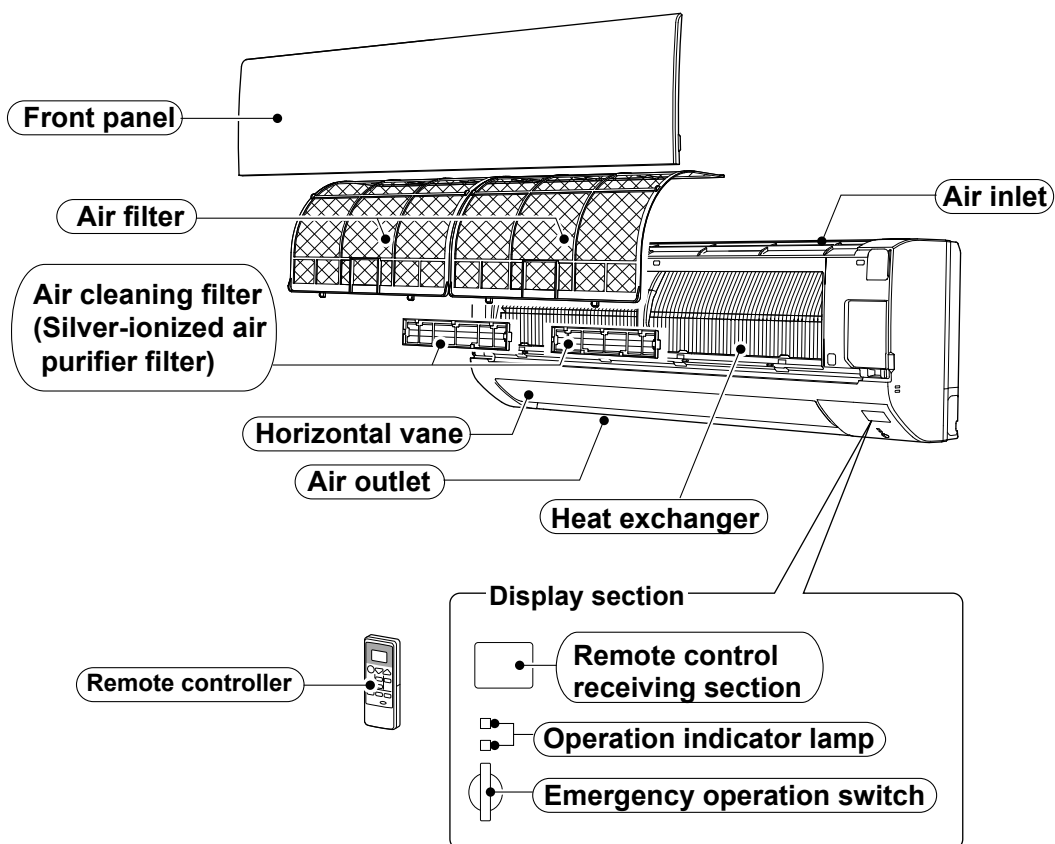

## ACCESSORIES

①	Installation plate	1
②	Installation plate fixing screw 4 × 25 mm	5
③	Wireless remote controller	1
④	Felt tape (For left or left-rear piping)	1
⑤	Battery (AAA) for remote controller	2
⑥	Air cleaning filter (Silver-ionized air purifier filter)	1

## 3

## SPECIFICATION

Indoor model			MSZ-DM25VA	MSZ-DM35VA	
Power supply			Single phase 230 V, 50 Hz		
Breaker Capacity		A	10		
Electrical data	Power input *1 (Total)	Cooling	710	1,020	
		Heating	850	975	
	Running current *1 (Total)	Cooling	3.6	4.8	
		Heating	4.1	4.7	
	Power factor *1 (Total)	Cooling	85	92	
		Heating	90		
Starting current *1 (Total)		A	4.1	4.8	
Fan motor	Model		RC0J40-EF		
	Current *1	Cooling	0.19	0.24	
Heating		0.20	0.22		
Dimensions W × H × D		mm	799 × 290 × 232		
Weight		kg	9		
Special remarks	Air direction		5		
	Air flow	Cooling	Super High	570	654
			High	438	468
			Med.	330	342
			Low	228	
		Heating	Super High	600	618
			High	450	
			Med.	330	
			Low	210	
	Sound level	Cooling	Super High	43	45
			High	37	38
			Med.	30	31
			Low	22	
		Heating	Super High	43	44
			High	37	
			Med.	30	
			Low	23	
	Fan speed	Cooling	Super High	1,080	1,200
High			880	930	
Med.			710	730	
Low			550		
Heating		Super High	1,120	1,150	
		High	900		
		Med.	710		
		Low	520		
Fan speed regulator			4		
Remote controller model			RH16A		

**NOTE:** Test conditions are based on ISO 5151.

Cooling : Indoor Dry-bulb temperature 27°C  
Outdoor Dry-bulb temperature 35°C

Wet-bulb temperature 19°C

Heating : Indoor Dry-bulb temperature 20°C  
Outdoor Dry-bulb temperature 7°C

Wet-bulb temperature 6°C

\*1 Measured under rated operating frequency.

#### Specifications and rated conditions of main electric parts

Fuse	(F11)	T3.15AL250V
Horizontal vane motor	(MV)	12 VDC
Varistor	(NR11)	S10K300E2K1 (ERZV10D471)
Terminal block	(TB)	5P

## MSZ-DM25VA

FAN SPEED	FUNCTION	SPL(dB(A))	LINE
Super High	COOLING	43	●—●
	HEATING	43	○—○

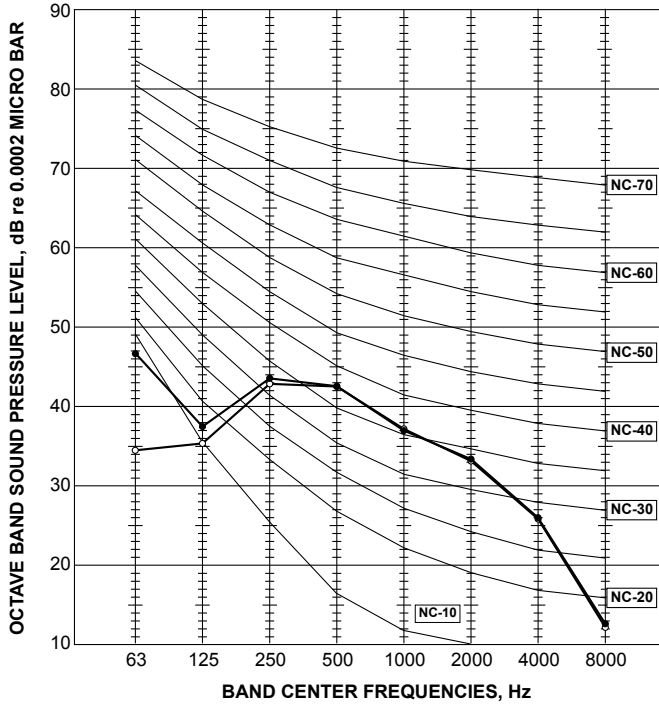

## MSZ-DM35VA

FAN SPEED	FUNCTION	SPL(dB(A))	LINE
Super High	COOLING	45	●—●
	HEATING	44	○—○

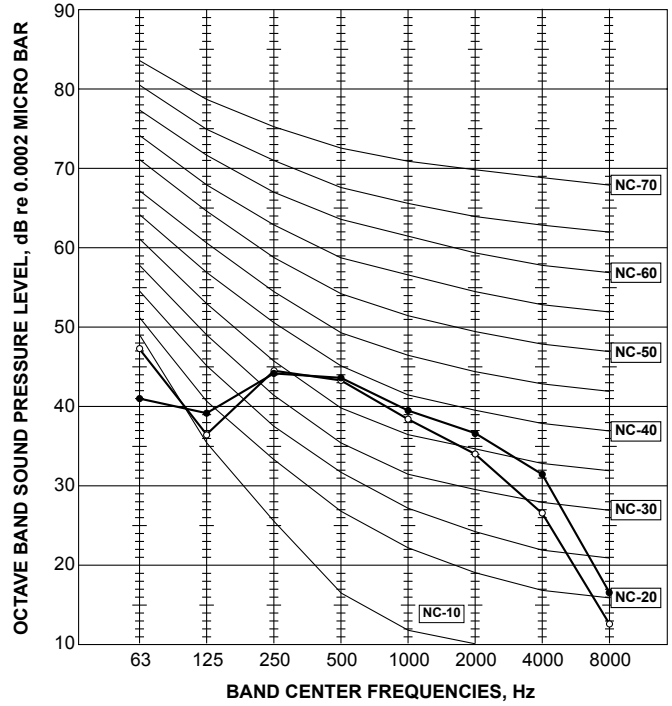

**Test conditions**

Cooling : Dry-bulb temperature 27°C Wet-bulb temperature 19°C  
 Heating : Dry-bulb temperature 20°C

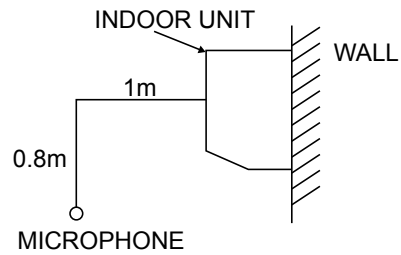

# 5

# OUTLINES AND DIMENSIONS

MSZ-DM25VA MSZ-DM35VA

Unit: mm

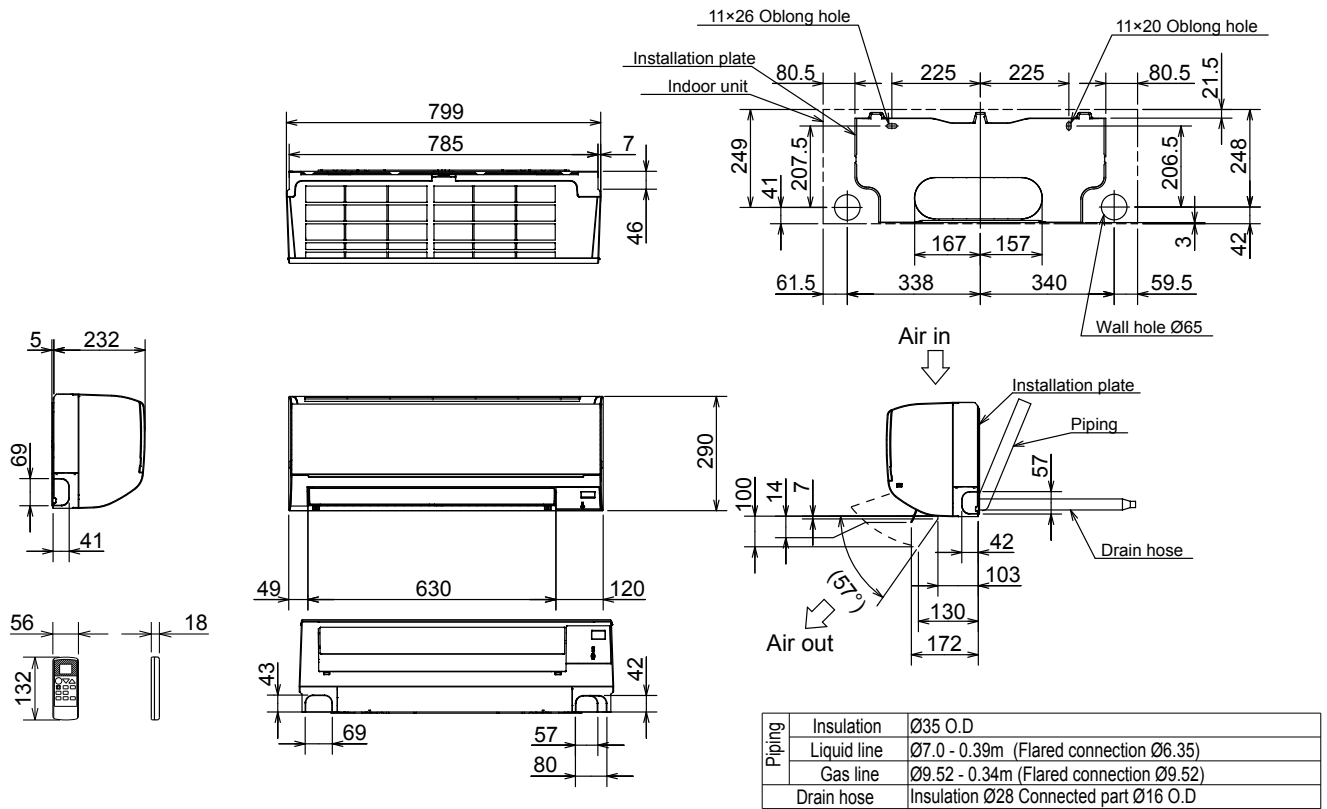

# 6

# WIRING DIAGRAM

MSZ-DM25VA -[E1], [ER1] MSZ-DM35VA -[E1], [ER1]

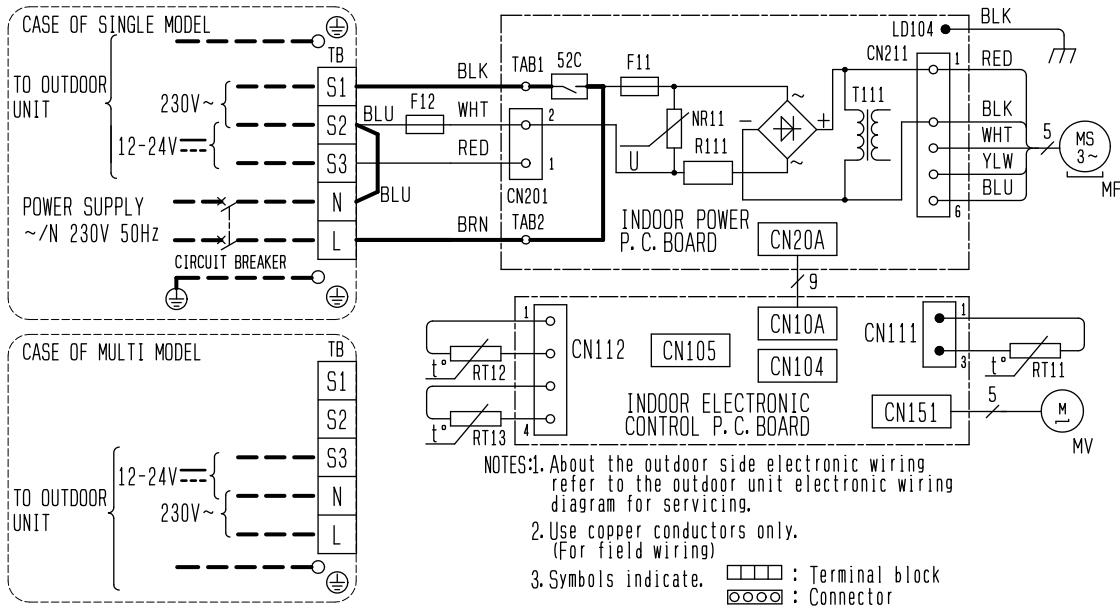

SYMBOL	NAME
F11	FUSE (T3. 15AL250V)
F12	THERMAL FUSE (102°C 5A)
MF	FAN MOTOR
MV	VANE MOTOR (HORIZONTAL)
NR11	VARISTOR
R111	RESISTOR
RT11	ROOM TEMP. THERMISTOR
RT12	COIL TEMP. THERMISTOR (MAIN)
RT13	COIL TEMP. THERMISTOR (SUB)
T111	TRANSFORMER
TB	TERMINAL BLOCK
52C	CONTACTOR
TAB1, TAB2	TAB



MSZ-DM25VA MSZ-DM35VA

Unit: mm

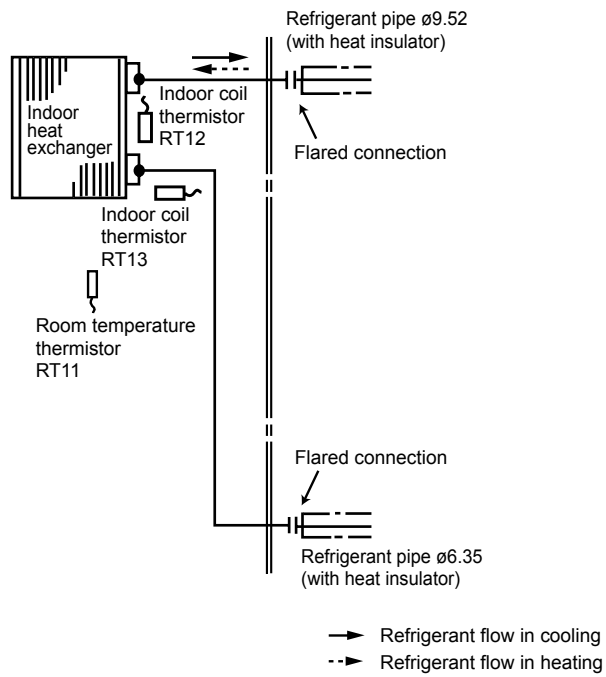

## MSZ-DM25VA MSZ-DM35VA

### 8-1. TIMER SHORT MODE

For service, the following set time can be shortened by bridging the timer short mode point on the electronic control P.C. board. (Refer to 10-7.)

Set time : 3-minute → 3-second (It takes 3 minutes for the compressor to start operation. However, the starting time is shortened by bridging the timer short mode point.)

**NOTE:** While the relay 52C is ON, the compressor starting time cannot be shortened.

### 8-2. P.C. BOARD MODIFICATION FOR INDIVIDUAL OPERATION

A maximum of 4 indoor units with wireless remote controllers can be used in a room.

In this case, to operate each indoor unit individually by each remote controller, P.C. boards of remote controller must be modified according to the number of the indoor unit.

#### How to modify the remote controller P.C. board

Remove batteries before modification.

The board has a print as shown below :

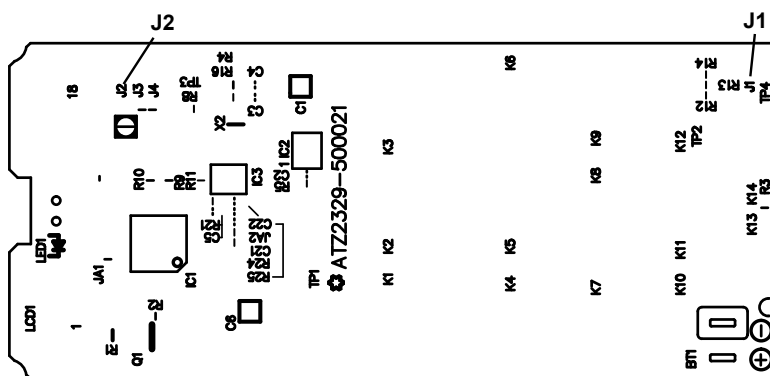

**NOTE :** For modification, take out the batteries and press the STOP/OPERATE/ (OFF/ ON) button 2 or 3 times at first. After finish modification, put back the batteries then press the RESET button.

The P.C. board has the print “J1” and “J2”. Cut “J1” and “J2” according to the number of indoor unit as shown in Table 1. After modification, press the RESET button.

**Table 1**

	1 unit operation	2 units operation	3 units operation	4 units operation
No. 1 unit	No modification	Same as at left	Same as at left	Same as at left
No. 2 unit	—	Cut J1	Same as at left	Same as at left
No. 3 unit	—	—	Solder J2	Same as at left
No. 4 unit	—	—	—	Cut J1 and solder J2

#### How to set the remote controller exclusively for particular indoor unit

After you turn the breaker ON, the first remote controller that sends the signal to the indoor unit will be regarded as the remote controller for the indoor unit.

The indoor unit will only accept the signal from the remote controller that has been assigned to the indoor unit once they are set.

The setting will be cancelled if the breaker is turned OFF, or the power supply is shut down.

Please conduct the above setting once again after the power has been restored.

### 8-3. AUTO RESTART FUNCTION

When the indoor unit is controlled with the remote controller, the operation mode, the set temperature, and the fan speed are memorized by the indoor electronic control P.C. board. "AUTO RESTART FUNCTION" automatically starts operation in the same mode just before the shutoff of the main power.

#### Operation

- ① If the main power has been cut, the operation settings remain.
- ② After the power is restored, the unit restarts automatically according to the memory.  
(However, it takes at least 3 minutes for the compressor to start running.)

#### How to disable "AUTO RESTART FUNCTION"

- ① Turn off the main power for the unit.
- ② Cut the Jumper wire to JR77 on the indoor electronic control P.C. board. (Refer to 10-7.)

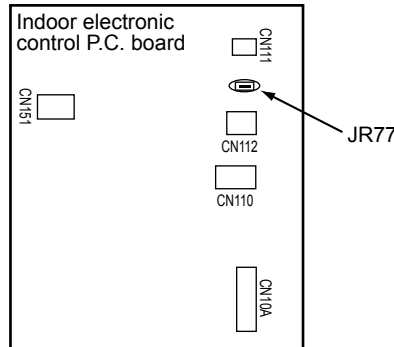

#### NOTE:

- The operation settings are memorized when 10 seconds have passed after the indoor unit was operated with the remote controller.
- If main power is turned OFF or a power failure occurs while AUTO START/STOP timer is active, the timer setting is cancelled.
- If the unit has been turned OFF with the remote controller before power failure, the auto restart function does not work as the power button of the remote controller is off.
- To prevent the breaker from tripping OFF due to the rush of starting current, systematize other home appliance not to turn ON at the same time.
- When some air conditioners are connected to the same supply system, if they are operated before power failure, the starting current of all the compressors may flow simultaneously at restart. Therefore, the special countermeasures are required to prevent the main voltage-drop or the rush of the starting current by adding to the system that allows the units to start one by one.

## MSZ-DM25VA MSZ-DM35VA

## WIRELESS REMOTE CONTROLLER

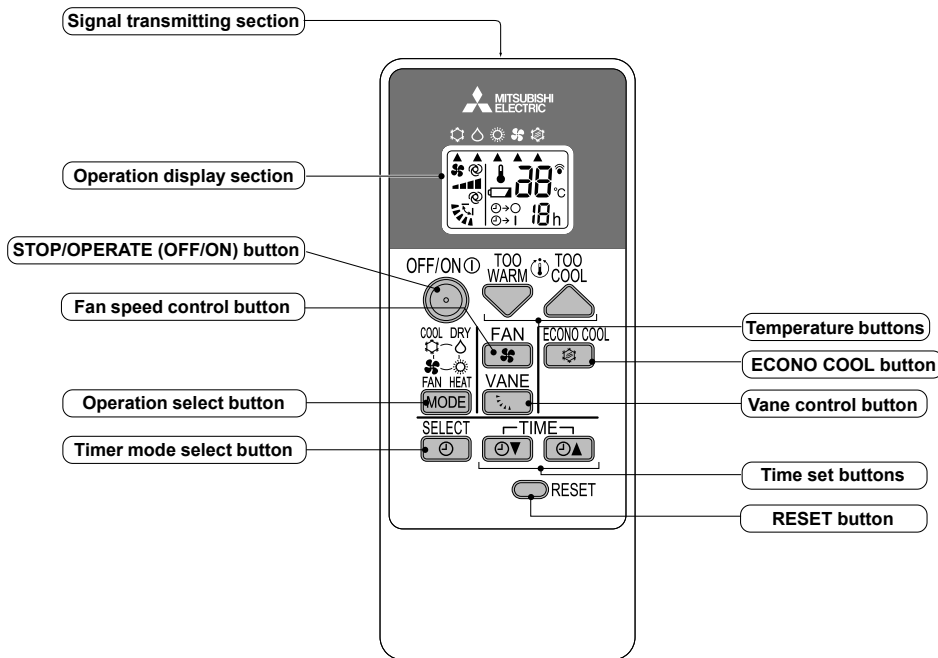

**NOTE :** Last setting will be stored after the unit is turned OFF with the remote controller. Indoor unit receives the signal of the remote controller with beeps.

## INDOOR UNIT DISPLAY SECTION

## Operation Indicator lamp

The operation indicator at the right side of the indoor unit indicates the operation state.

•The following indication applies regardless of shape of the indication.

Indication	Operation state	Room temperature	
●	The unit is operating to reach the set temperature	About 2°C or more away from set temperature	● Lighted
○			○ Not lighted
●	The room temperature is approaching the set temperature	About 1 to 2°C from set temperature	● Lighted
○			○ Not lighted
●	Standby mode (Only during multi system operation)	—	● Lighted
○			○ Not lighted

## 9-1. COOL (❄️) OPERATION

(1) Press STOP/OPERATE/ (OFF/ON) button.

OPERATION INDICATOR lamp of the indoor unit turns on with a beep tone.

(2) Select COOL mode with OPERATION SELECT button.

(3) Press TEMPERATURE buttons (TOO WARM or TOO COOL button) to select the desired temperature.  
The setting range is 16 ~ 31°C.

## 1. Coil frost prevention

The compressor operational frequency is controlled by the temperature of the indoor heat exchanger to prevent the coil from frosting.

When the temperature of indoor heat exchanger becomes too low, the coil frost prevention mode works. The indoor fan operates at the set speed and the compressor stops. This mode continues until the temperature of indoor heat exchanger rises.

## 9-2. DRY (△) OPERATION

- (1) Press STOP/OPERATE/ (OFF/ON) button.  
OPERATION INDICATOR lamp of the indoor unit turns on with a beep tone.
- (2) Select DRY mode with OPERATION SELECT button.
- (3) The set temperature is determined from the initial room temperature.

### 1. Coil frost prevention

Coil frost prevention works the same way as that in COOL mode. (9-1.1.)

## 9-3. HEAT (☀) OPERATION

- (1) Press STOP/OPERATE/ (OFF/ON) button.  
OPERATION INDICATOR lamp of the indoor unit turns on with a beep tone.
- (2) Select HEAT mode with OPERATION SELECT button.
- (3) Press TEMPERATURE buttons (TOO WARM or TOO COOL button) to select the desired temperature.  
The setting range is 16 ~ 31°C.

### 1. Cold air prevention control

When the compressor is not operating or is starting, and the temperature of indoor heat exchanger and/or the room temperature is low or when defrosting is being done, the indoor fan will stop or rotate in Very Low speed.

### 2. High pressure protection

The compressor operational frequency is controlled by the temperature of the indoor heat exchanger to prevent the condensing pressure from increasing excessively.

When the temperature of indoor heat exchanger becomes too high, the high pressure protection works.

The indoor fan operates following the cold air prevention control. This mode continues until the temperature of indoor heat exchanger falls.

### 3. Defrosting

Defrosting starts when the temperature of outdoor heat exchanger becomes too low.

The compressor stops once, the indoor/outdoor fans stop, the 4-way valve reverses, and the compressor re-starts.

This mode continues until the temperature of outdoor heat exchanger rises or the fixed time passes.

## 9-4. AUTO VANE OPERATION

### 1. Horizontal vane

- (1) Vane motor drive  
These models are equipped with a stepping motor for the horizontal vane. The rotating direction, speed, and angle of the motor are controlled by pulse signals (approximately 12 V) transmitted from indoor microprocessor.
- (2) The horizontal vane angle and mode change as follows by pressing VANE CONTROL button.

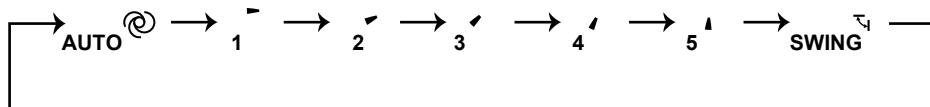

### (3) Positioning

To confirm the standard position, the vane moves until it touches the vane stopper. Then the vane is set to the selected angle.

Confirmation of standard position is performed in the following cases:

- (a) When the operation starts or finishes (including timer operation).
- (b) When the test run starts.
- (c) When standby mode (only during multi system operation) starts or finishes.

### (4) VANE AUTO (@) mode

In VANE AUTO mode, the microprocessor automatically determines the vane angle to make the optimum room temperature distribution.

In COOL and DRY operation  
Vane angle is fixed to Horizontal position.

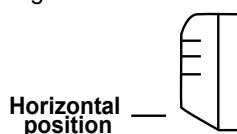

In HEAT operation  
Vane angle is fixed to Angle 4.

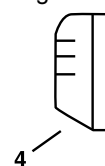

(5) STOP (operation OFF) and ON TIMER standby

In the following cases, the horizontal vane returns to the closed position.

- (a) When STOP/OPERATE/ (OFF/ON) button is pressed (POWER OFF).
- (b) When the operation is stopped by the emergency operation.
- (c) When ON TIMER is ON standby.

(6) Dew prevention

During COOL or DRY operation with the vane angle at Angle 3 ~ 5 when the compressor cumulative operation time exceeds 1 hour, the vane angle automatically changes to Angle 2 for dew prevention.

(7) SWING (↕) mode

By selecting SWING mode with VANE CONTROL button, the horizontal vane swings vertically.

(8) Cold air prevention in HEAT operation.

The horizontal vane position is set to Upward.

**NOTE:** When 2 or more indoor units are operated with multi outdoor unit, even if any indoor unit turns thermostat off, this control does not work in the indoor unit.

(9) ECONO COOL (🌀) operation (ECONOMICAL operation)

When ECONO COOL button is pressed in COOL mode, set temperature is automatically set 2°C higher.

Also the horizontal vane swings in various cycle.

SWING operation makes you feel cooler than set temperature. So, even though the set temperature is higher, the air conditioner can keep comfort. As a result, energy can be saved.

ECONO COOL operation is cancelled when ECONO COOL button is pressed once again or VANE CONTROL button is pressed or change to other operation mode.

## 9-5. TIMER OPERATION (ON/OFF TIMER)



### 1. How to set the timer

(1) Press STOP/OPERATE/ (OFF/ON) button to start the air conditioner.

(2) Select the timer mode by pressing the  button during operation.

Each time this button is pressed, the timer mode is changed in sequence:

☉→○ (OFF TIMER) → ☉→| (ON TIMER) → TIMER RELEASE

(3) Set the time of the timer using the   button.

Each time this button is pressed, the set time increase or decrease by 1 hour to 12 hours.

### 2. To release the timer

Press the  button until ☉→○ (OFF TIMER) and ☉→| (ON TIMER) are not displayed.

#### NOTE :

- The OFF TIMER and the ON TIMER cannot be set at the same time.
- The displayed time is the time remaining and will decrease in 1-hour increments as time passes.



### 9-6. EMERGENCY/TEST OPERATION

In the case of test run operation or emergency operation, use EMERGENCY OPERATION switch on the right side of the indoor unit. Emergency operation is available when the remote controller is missing or has failed, or when the batteries in the remote controller are running down. The unit will start and OPERATION INDICATOR lamp will light up.

The first 30 minutes of operation is the test run operation. This operation is for servicing. The indoor fan runs at High speed and the temperature control does not work.

After 30 minutes of test run operation, the system shifts to EMERGENCY COOL/HEAT MODE with a set temperature of 24°C. The fan speed shifts to Med.

The coil frost prevention works even in the test run or the emergency operation.

In the test run or emergency operation, the horizontal vane operates in VANE AUTO (@) mode.

Emergency operation continues until EMERGENCY OPERATION switch is pressed once or twice or the unit receives any signal from the remote controller. In the latter case, normal operation will start.

**NOTE:** Do not press EMERGENCY OPERATION switch during normal operation.



Operation mode	COOL	HEAT
Set temperature	24°C	24°C
Fan speed	Med.	Med.
Horizontal vane	Auto	Auto

The operation mode is indicated by the Operation Indicator lamp as follows:

#### Operation Indicator lamp

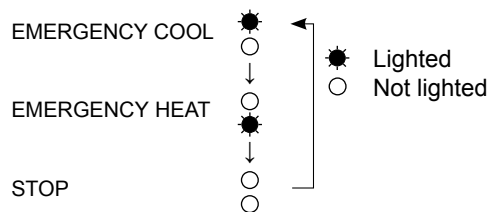

### 9-7. 3-MINUTE TIME DELAY OPERATION

When the system turns OFF, compressor will not restart for 3 minutes as 3-minute time delay function operates to protect compressor from overload.

## MSZ-DM25VA MSZ-DM35VA

## 10-1. CAUTIONS ON TROUBLESHOOTING

## 1. Before troubleshooting, check the following:

- 1) Check the power supply voltage.
- 2) Check the indoor/outdoor connecting wire for miswiring.

## 2. Take care of the following during servicing

- 1) Before servicing the air conditioner, be sure to turn OFF the main unit first with the remote controller, and then after confirming the horizontal vane is closed, turn OFF the breaker and/or disconnect the power plug.
- 2) Be sure to turn OFF the power supply before removing the front panel, the cabinet, the top panel, and the P.C. board.
- 3) When removing the P.C. board, hold the edge of the board with care NOT to apply stress on the components.
- 4) When connecting or disconnecting the connectors, hold the connector housing. DO NOT pull the lead wires.

&lt;Incorrect&gt;

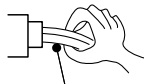

Lead wiring

&lt;Correct&gt;

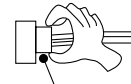

Connector housing

## 3. Troubleshooting procedure

- 1) Check if the OPERATION INDICATOR lamp on the indoor unit is flashing ON and OFF to indicate an abnormality. To make sure, check how many times the OPERATION INDICATOR lamp is flashing ON and OFF before starting service work.
- 2) Before servicing, check that the connector and terminal are connected properly.
- 3) When the P.C. board seems to be defective, check the copper foil pattern for disconnection and the components for bursting and discoloration.
- 4) When troubleshooting, Refer to 10-2, 10-3 and 10-4.

## 4. How to replace batteries

Weak batteries may cause the remote controller malfunction.

In this case, replace the batteries to operate the remote controller normally.

- ① Remove the back lid and insert batteries. Then reattach the back lid.

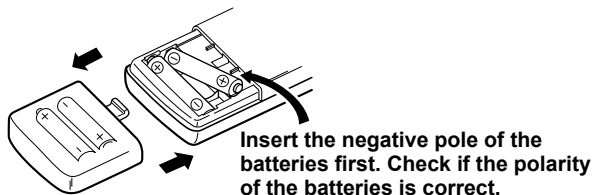

- ② Press RESET button with a thin instrument, and then use the remote controller.

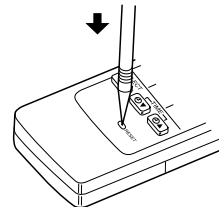

**NOTE:** 1. If RESET button is not pressed, the remote controller may not operate correctly.

2. This remote controller has a circuit to automatically reset the microcomputer when batteries are replaced. This function is equipped to prevent the microcomputer from malfunctioning due to the voltage drop caused by the battery replacement.
3. Do not use the leaking batteries.



## 10-2. FAILURE MODE RECALL FUNCTION

### Outline of the function

This air conditioner can memorize the abnormal condition which has occurred once.

Even though LED indication listed on the troubleshooting check table (10-4.) disappears, the memorized failure details can be recalled.

This mode is very useful when the unit needs to be repaired for the abnormality which does not recur.

### 1. Flow chart of failure mode recall function for the indoor/outdoor unit

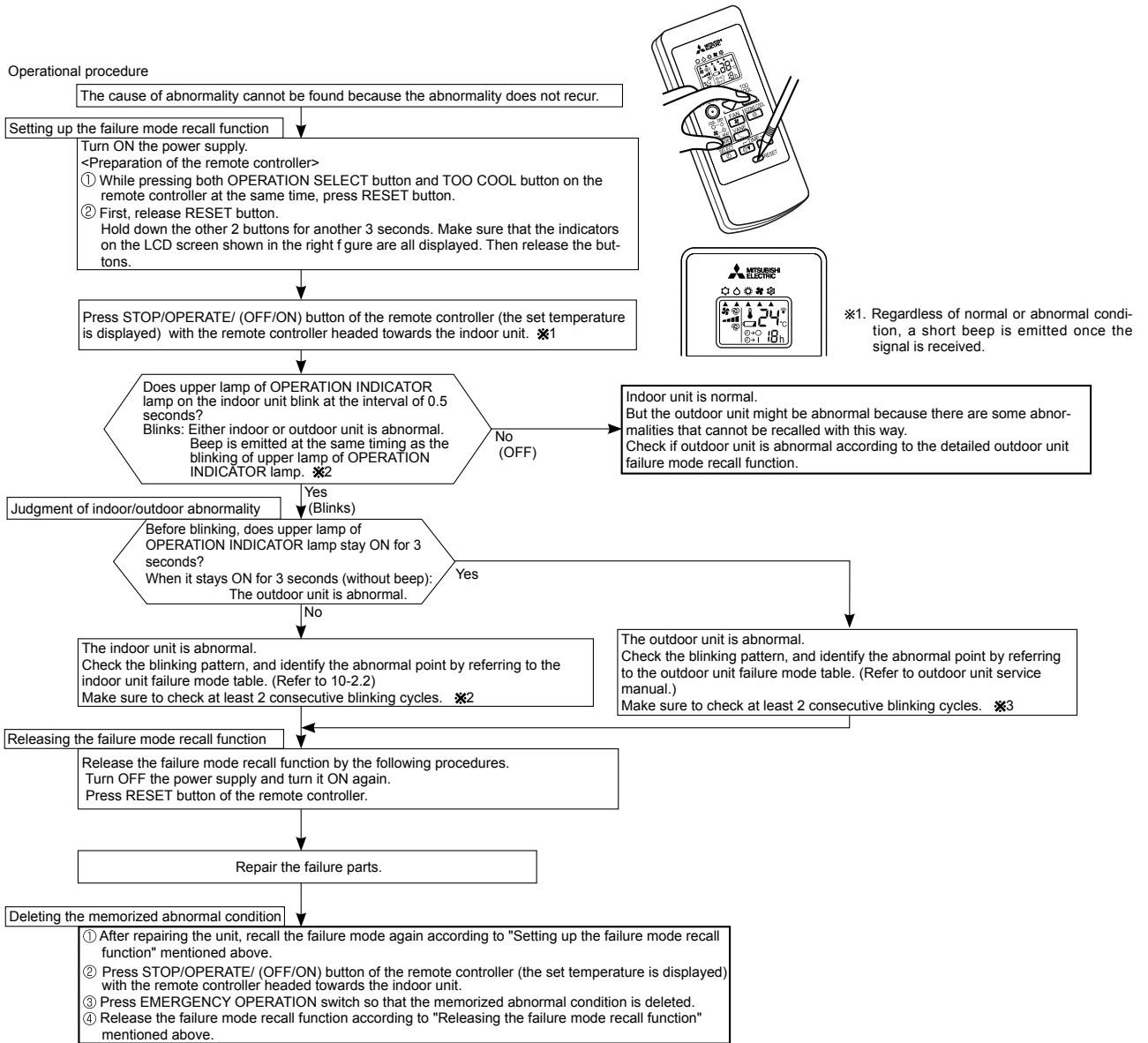

**NOTE:** 1. Make sure to release the failure mode recall function after it is set up, otherwise the unit cannot operate properly.  
 2. If the abnormal condition is not deleted from the memory, the last abnormal condition is kept memorized.

※2. Blinking pattern when the indoor unit is abnormal:

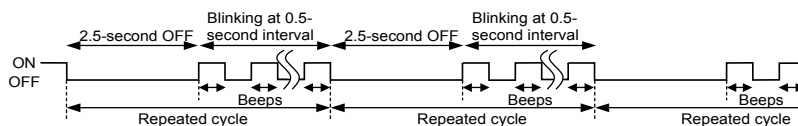

※3. Blinking pattern when the outdoor unit is abnormal:

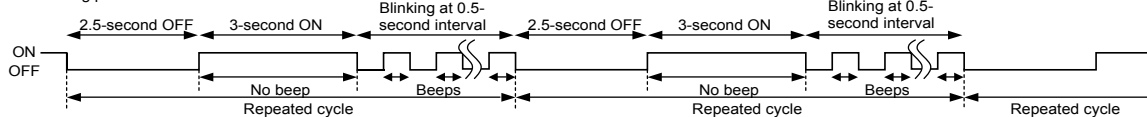



**2. Indoor unit failure mode table**

Upper lamp of OPERATION INDICATOR lamp	Abnormal point (Failure mode)	Condition	Remedy
Not lighted	Normal	—	—
1-time f ash every 0.5-second	Room temperature thermistor	The room temperature thermistor short or open circuit is detected every 8 seconds during operation.	Refer to the characteristics of the room temperature thermistor (10-7.).
2-time f ash 2.5-second OFF	Indoor coil thermistor	The indoor coil thermistor short or open circuit is detected every 8 seconds during operation.	Refer to the characteristics of the main indoor coil thermistor, the sub indoor coil thermistor (10-7.).
3-time f ash 2.5-second OFF	Serial signal	The serial signal from outdoor unit is not received for a maximum of 6 minutes.	Refer to 10-6.Ⓓ "How to check miswiring and serial signal error".
11-time f ash 2.5-second OFF	Indoor fan motor	The rotational frequency feedback signal is not emitted for the 12 seconds after the indoor fan motor is operated.	Refer to 10-6.Ⓐ "Check of indoor fan motor".
12-time f ash 2.5-second OFF	Indoor control system	It cannot properly read data in the nonvolatile memory of the indoor electronic control P.C. board.	Replace the indoor electronic control P.C. board.

**NOTE** : Blinking patterns of this mode differ from the ones of TROUBLESHOOTING CHECK TABLE (10-4.).

### 10-3. INSTRUCTION OF TROUBLESHOOTING

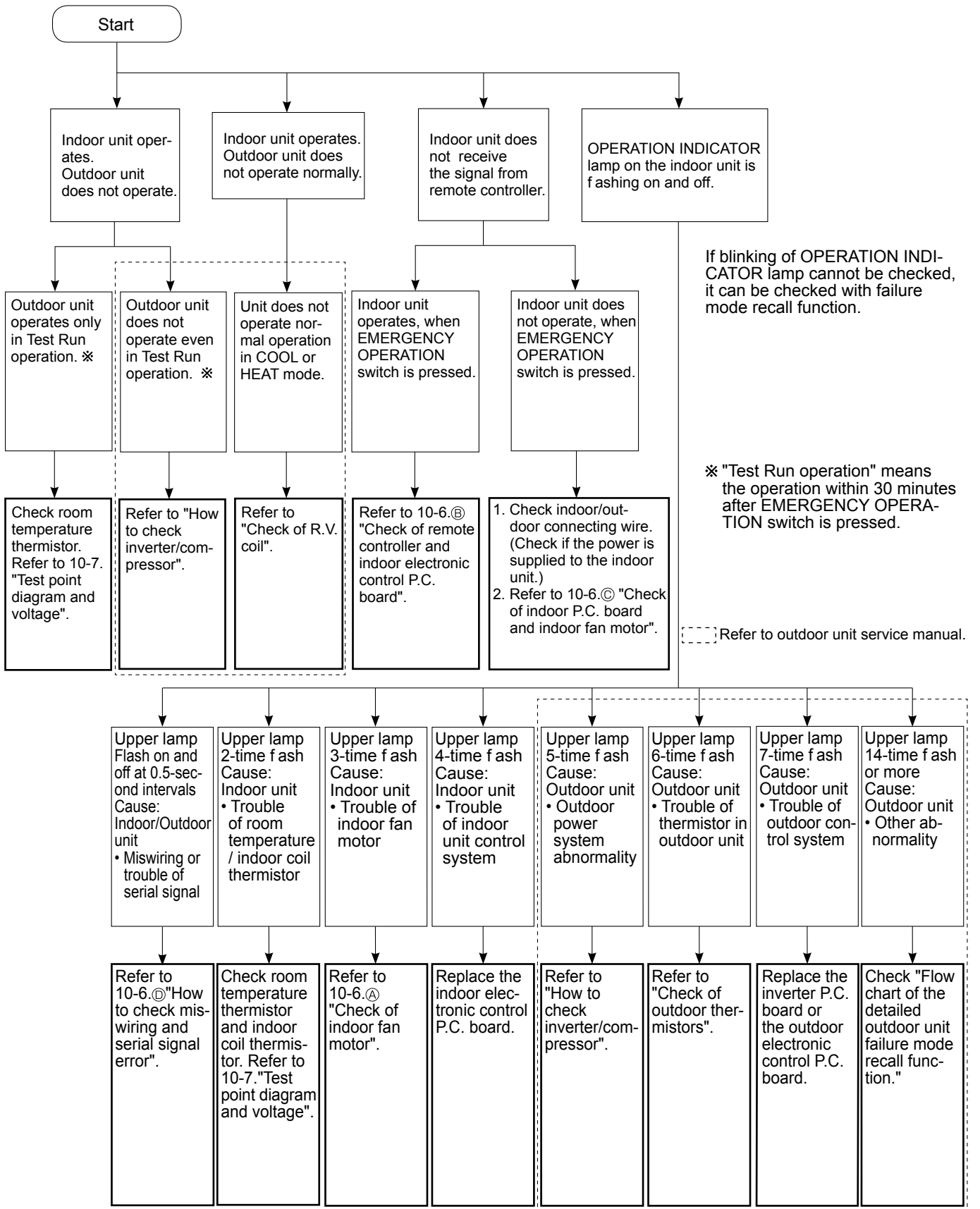



## 10-4. TROUBLESHOOTING CHECK TABLE

















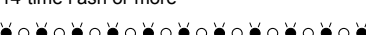



































































Before taking measures, make sure that the symptom reappears for accurate troubleshooting.

When the indoor unit has started operation and detected an abnormality of the following condition (the first detection after the power ON), the indoor fan motor turns OFF and OPERATION INDICATOR lamp flashes.

### OPERATION INDICATOR



-  Lighted
-  Blinking
-  Not lighted

No.	Abnormal point	Operation indicator lamp	Symptom	Condition	Remedy
1	Miswiring or serial signal	Upper lamp flashes. 0.5-second ON      0.5-second OFF	Indoor unit and outdoor unit do not operate.	The serial signal from the outdoor unit is not received for 6 minutes.	• Refer to 10-6. ③ "How to check miswiring and serial signal error".
2	Indoor coil thermistor Room temperature thermistor	Upper lamp flashes. 2-time f ash          2.5-second OFF		The indoor coil or the room temperature thermistor is short or open circuit.	• Refer to the characteristics of indoor coil thermistor, and the room temperature thermistor (10-7.).
3	Indoor fan motor	Upper lamp flashes. 3-time f ash          2.5-second OFF		The rotational frequency feedback signal is not emitted during the indoor fan operation.	• Refer to 10-6. ④ "Check of indoor fan motor".
4	Indoor control system	Upper lamp flashes. 4-time f ash           2.5-second OFF		It cannot properly read data in the nonvolatile memory of the indoor electronic control P.C. board.	• Replace the indoor electronic control P.C. board.
5	Outdoor power system	Upper lamp flashes. 5-time f ash           2.5-second OFF		It consecutively occurs 3 times that the compressor stops for overcurrent protection or start-up failure protection within 1 minute after start-up.	• Refer to "How to check of inverter/compressor". • Refer to outdoor unit service manual • Check the stop valve.
6	Outdoor thermistors	Upper lamp flashes. 6-time f ash           2.5-second OFF		The outdoor thermistors short or open circuit during the compressor operation.	• Refer to "Check of outdoor thermistor". • Refer to outdoor unit service manual.
7	Outdoor control system	Upper lamp flashes. 7-time f ash           2.5-second OFF		It cannot properly read data in the nonvolatile memory of the inverter P.C. board or the outdoor electronic control P.C. board.	• Replace the inverter P.C. board or the outdoor electronic control P.C. board. • Refer to outdoor unit service manual.
8	Other abnormality	Upper lamp flashes. 14-time f ash or more                      2.5-second OFF		An abnormality other than above mentioned is detected.	• Check the stop valve. • Check the 4-way valve. • Confirm the abnormality in detail using the failure mode recall function for outdoor unit.
9	Outdoor control system	Upper lamp lights up 		Outdoor unit does not operate	It cannot properly read data in the nonvolatile memory of the inverter P.C. board or the outdoor electronic control P.C. board.

OPERATION INDICATOR

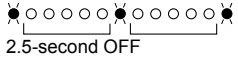

No.	Abnormal point	Operation indicator lamp	Symptom	Condition	Remedy
1	<b>MXZ type</b> Operation mode setting	Upper lamp lights and lower lamp flashes. 	Outdoor unit operates but indoor unit does not operate.	The operation mode of the each indoor unit is differently set to COOL (includes DRY) and HEAT at the same time, the operation mode of the indoor unit that has operated at first has the priority.	<ul style="list-style-type: none"> <li>Unify the operation mode. Refer to outdoor unit service manual.</li> </ul>

**10-5. TROUBLE CRITERION OF MAIN PARTS**  
**MSZ-DM25VA MSZ-DM35VA**

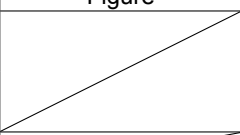
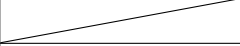
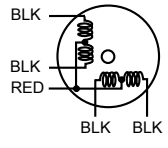
Part name	Check method and criterion	Figure				
Room temperature thermistor (RT11)	Measure the resistance with a tester.					
Indoor coil thermistor (RT12, RT13)	Refer to 10-7. "Test point diagram and voltage", "2. Indoor electronic control P.C. board", for the chart of thermistor.					
Indoor fan motor (MF)	Check 10-6.Ⓐ.					
Vane motor (MV)	Measure the resistance between the terminals with a tester. (Part temperature 10 ~ 30°C) <table border="1" data-bbox="462 1052 1117 1120"> <thead> <tr> <th>Color of the lead wire</th> <th>Normal</th> </tr> </thead> <tbody> <tr> <td>RED - BLK</td> <td>235 ~ 255 Ω</td> </tr> </tbody> </table>	Color of the lead wire	Normal	RED - BLK	235 ~ 255 Ω	
Color of the lead wire	Normal					
RED - BLK	235 ~ 255 Ω					

## 10-6. TROUBLESHOOTING FLOW

### A Check of indoor fan motor

The indoor fan motor error has occurred, and the indoor fan does not operate.

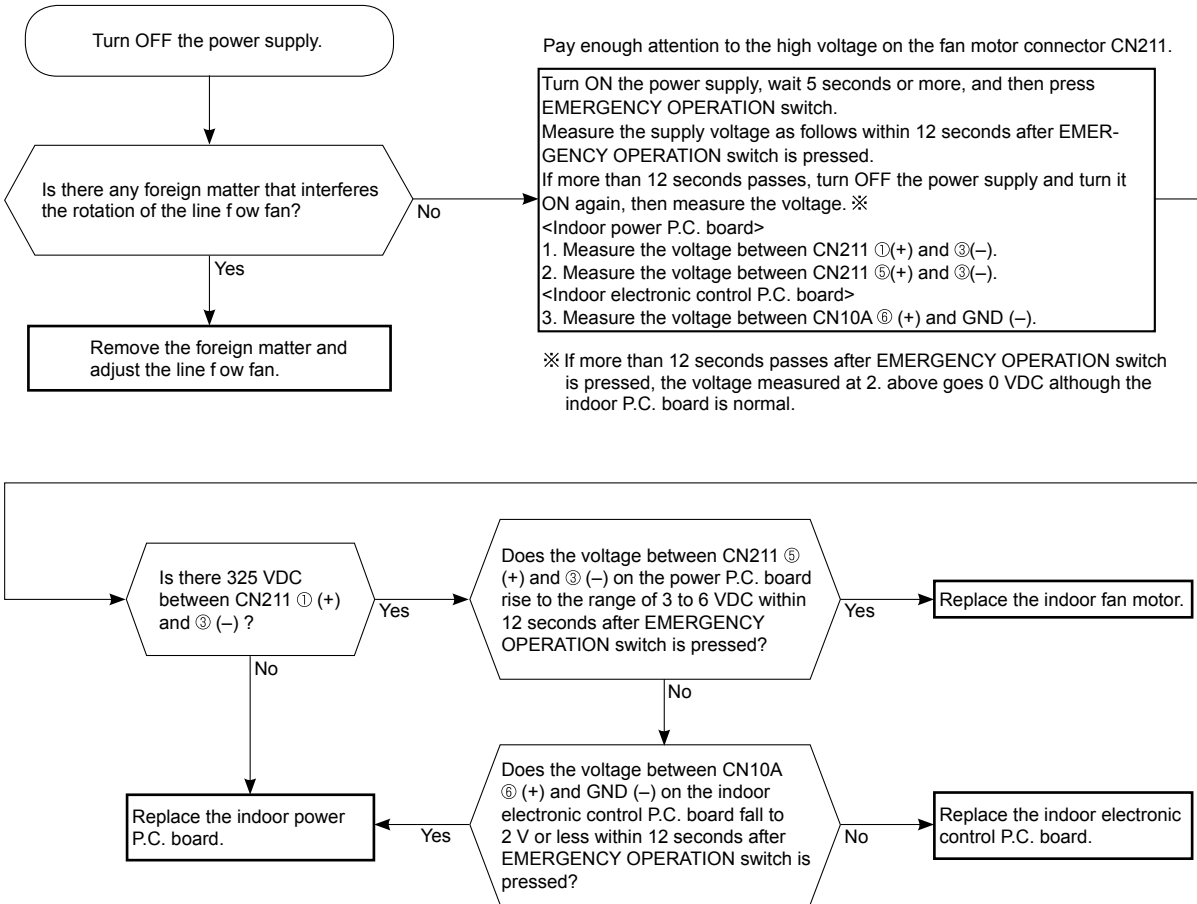

The indoor fan motor error has occurred, and the indoor fan repeats "12-second ON and 30-second OFF" 3 times, and then stops.

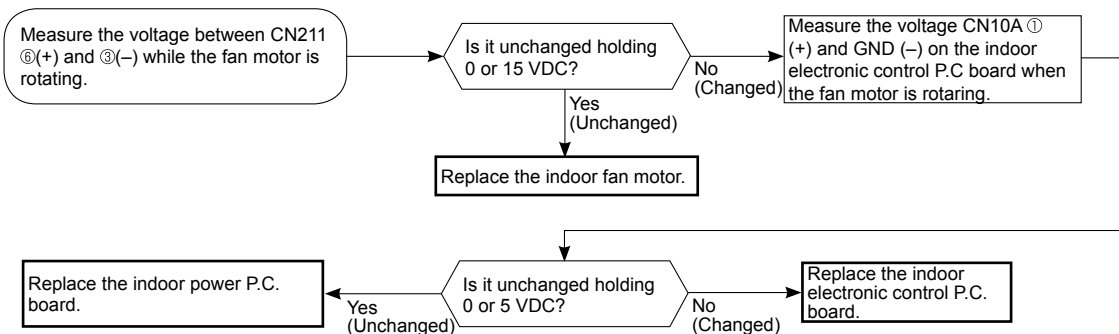

## B Check of remote controller and indoor electronic control P.C. board

※Check if the remote controller is exclusive for this air conditioner.

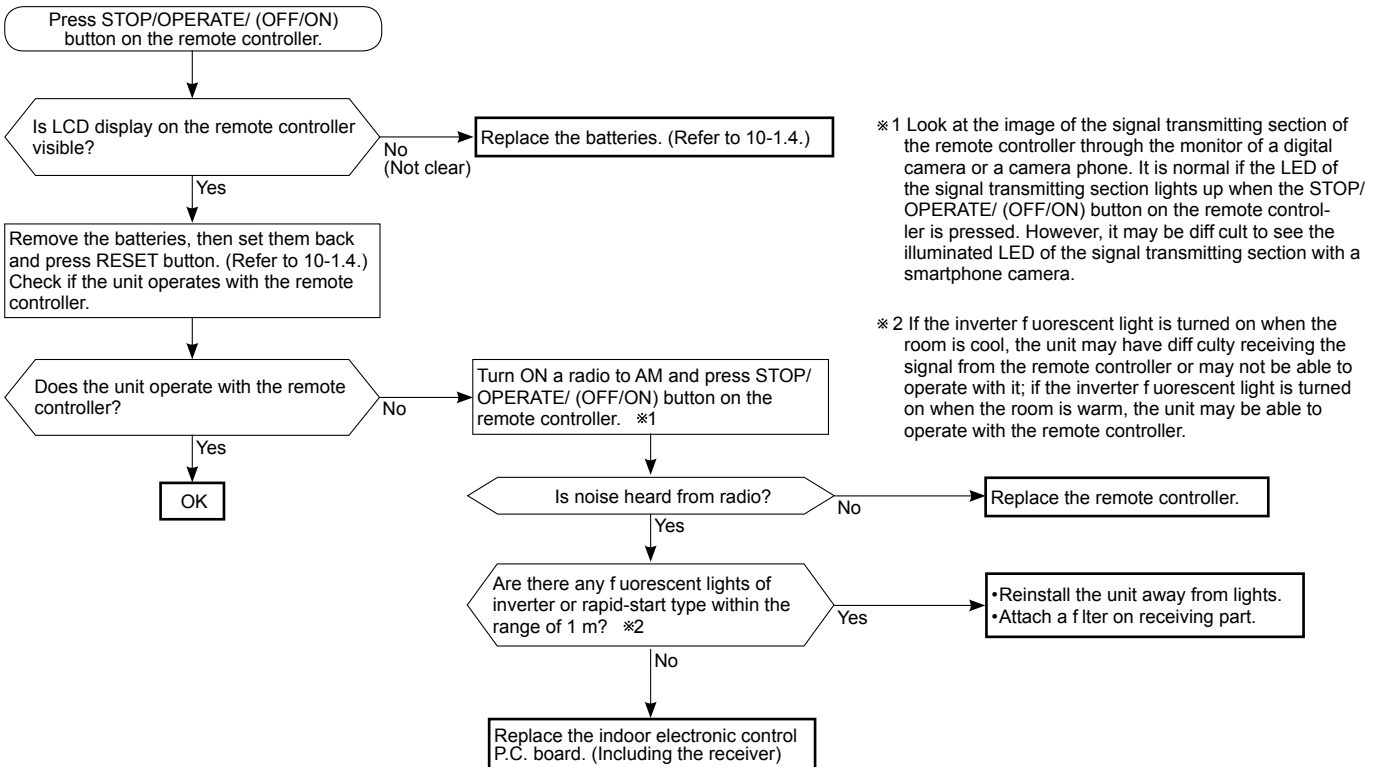

※ 1 Look at the image of the signal transmitting section of the remote controller through the monitor of a digital camera or a camera phone. It is normal if the LED of the signal transmitting section lights up when the STOP/ OPERATE/ (OFF/ON) button on the remote controller is pressed. However, it may be difficult to see the illuminated LED of the signal transmitting section with a smartphone camera.

※ 2 If the inverter fluorescent light is turned on when the room is cool, the unit may have difficulty receiving the signal from the remote controller or may not be able to operate with it; if the inverter fluorescent light is turned on when the room is warm, the unit may be able to operate with the remote controller.

## © Check of indoor P.C. board and indoor fan motor

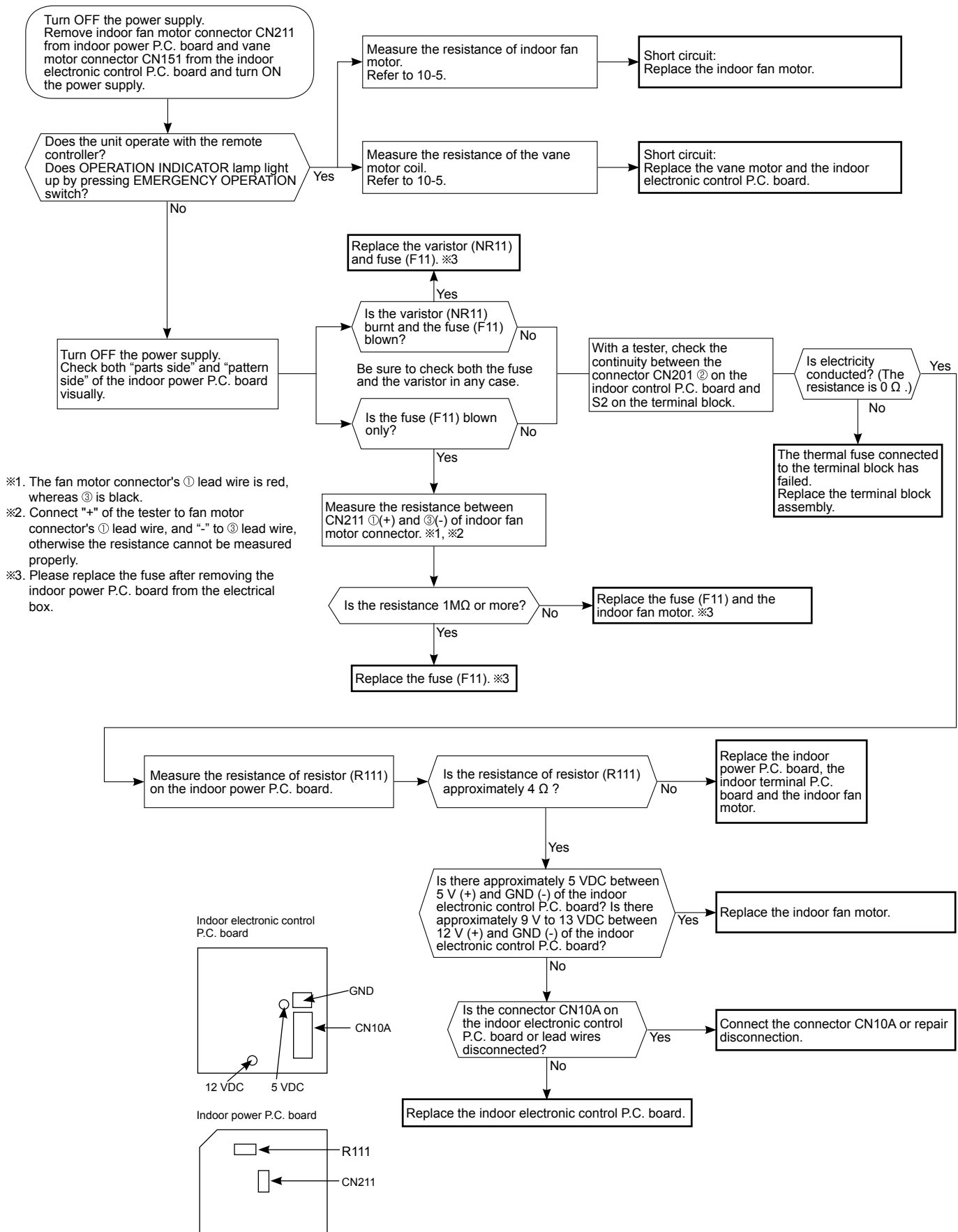

- ※1. The fan motor connector's ① lead wire is red, whereas ③ is black.
- ※2. Connect "+" of the tester to fan motor connector's ① lead wire, and "-" to ③ lead wire, otherwise the resistance cannot be measured properly.
- ※3. Please replace the fuse after removing the indoor power P.C. board from the electrical box.



## D How to check miswiring and serial signal error

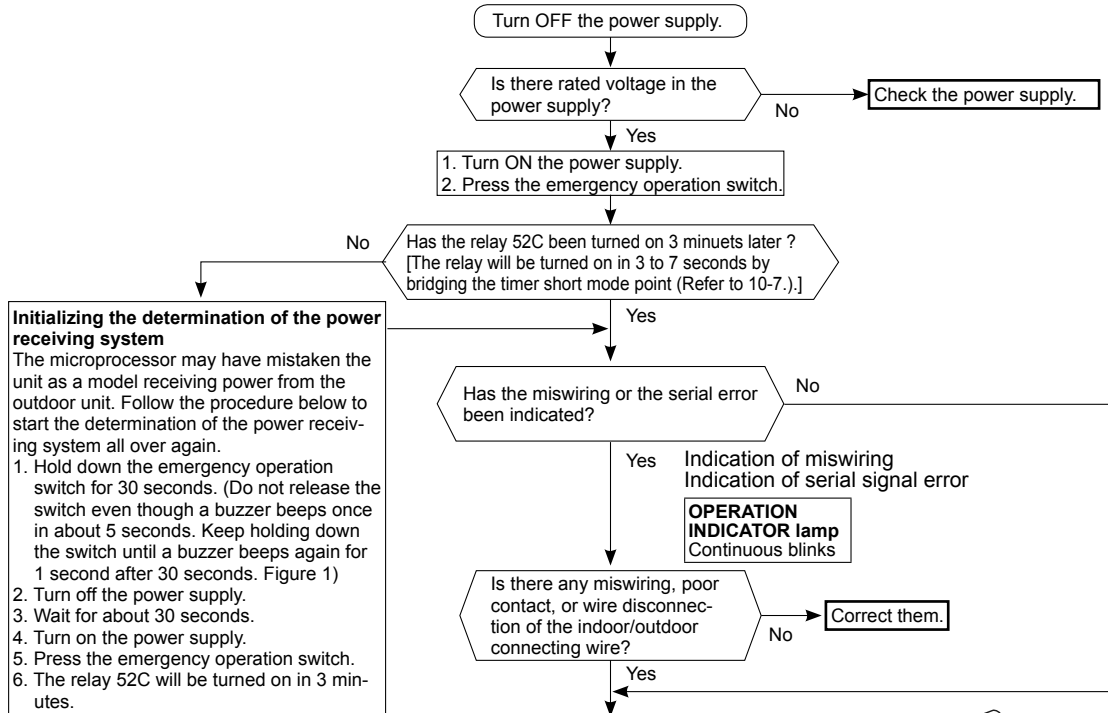
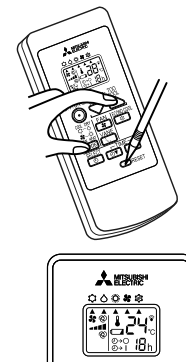
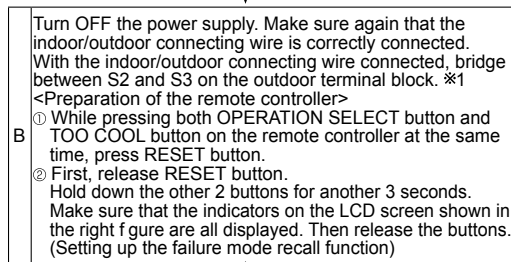
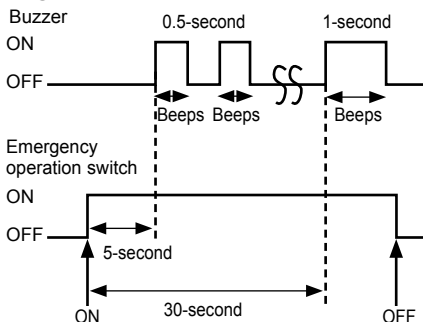
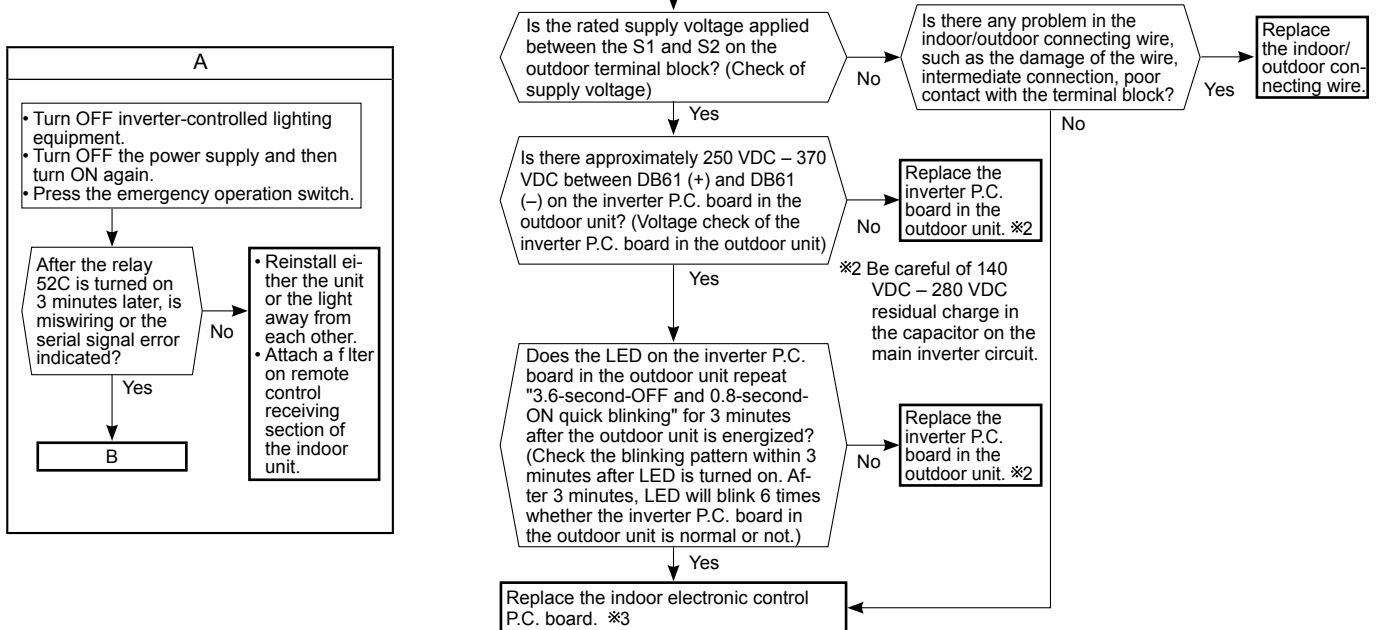

Figure 1



Aim the remote controller at the indoor unit, and press STOP/OPERATE/ (OFF/ON) button. The relay 52C will be turned on, and the outdoor unit will be energized.

\*1 Make sure that the wiring is correct. If the procedure is performed without correcting miswiring, it may lead to damage to the P.C. board.



## Ⓔ Electromagnetic noise enters into TV sets or radios

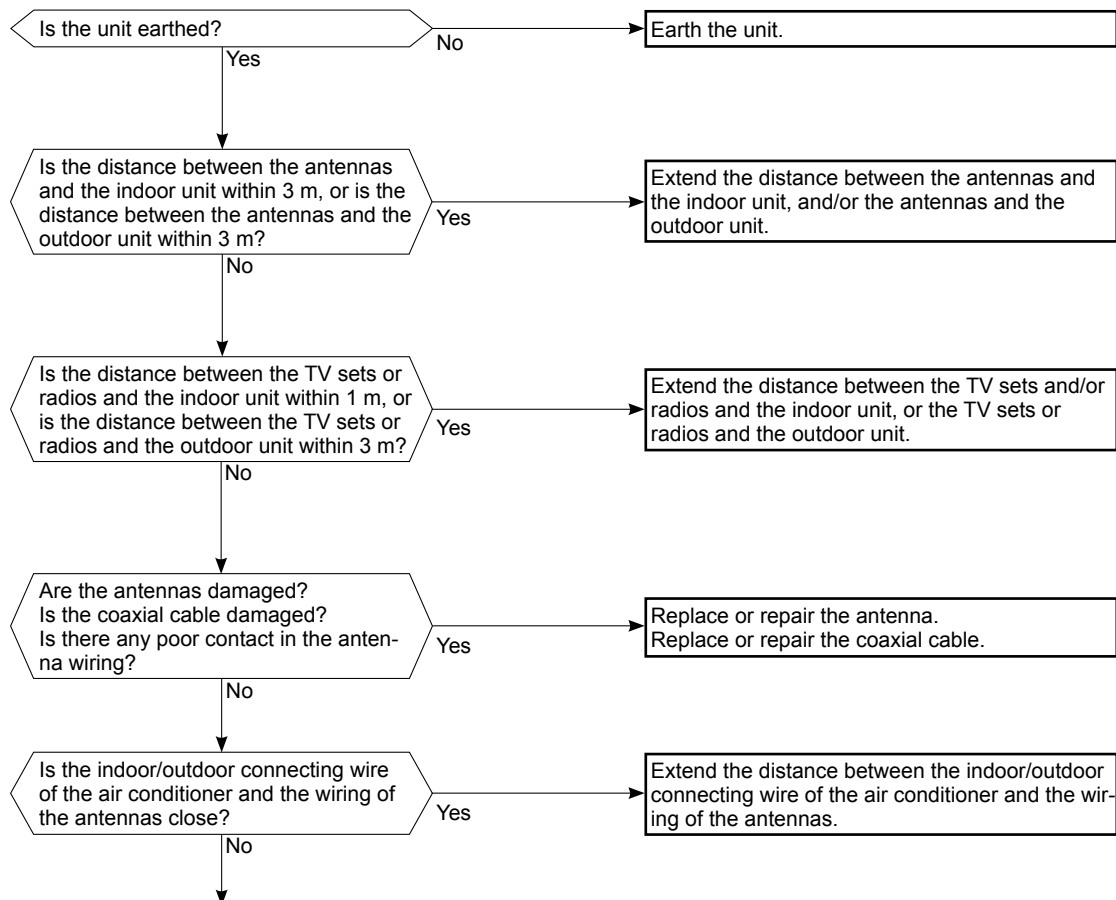

Even if all of the above conditions are fulfilled, the electromagnetic noise may enter, depending on the electric field strength or the installation condition (combination of specific conditions such as antennas or wiring).  
Check the following before asking for service.

1. Devices affected by the electromagnetic noise  
TV sets, radios (FM/AM broadcast, shortwave)
2. Channel, frequency, broadcast station affected by the electromagnetic noise
3. Channel, frequency, broadcast station unaffected by the electromagnetic noise
4. Layout of ;  
indoor/outdoor unit of the air conditioner, indoor/outdoor wiring, earth wire, antennas, wiring from antennas, receiver
5. Electric field intensity of the broadcast station affected by the electromagnetic noise
6. Presence or absence of amplifier such as booster
7. Operation condition of air conditioner when the electromagnetic noise enters in
  - 1) Turn OFF the power supply once, and then turn ON the power supply. In this situation, check for the electromagnetic noise.
  - 2) Within 3 minutes after turning ON the power supply, press STOP/OPERATE/ (OFF/ON) button on the remote controller for power ON, and check for the electromagnetic noise.
  - 3) After a short time (3 minutes later after turning ON), the outdoor unit starts running. During operation, check for the electromagnetic noise.
  - 4) Press STOP/OPERATE/ (OFF/ON) button on the remote controller for power OFF, when the outdoor unit stops but the indoor/outdoor communication still runs on. In this situation, check for the electromagnetic noise.

# 10-7. TEST POINT DIAGRAM AND VOLTAGE MSZ-DM25VA MSZ-DM35VA

## 1. Indoor power P.C. board

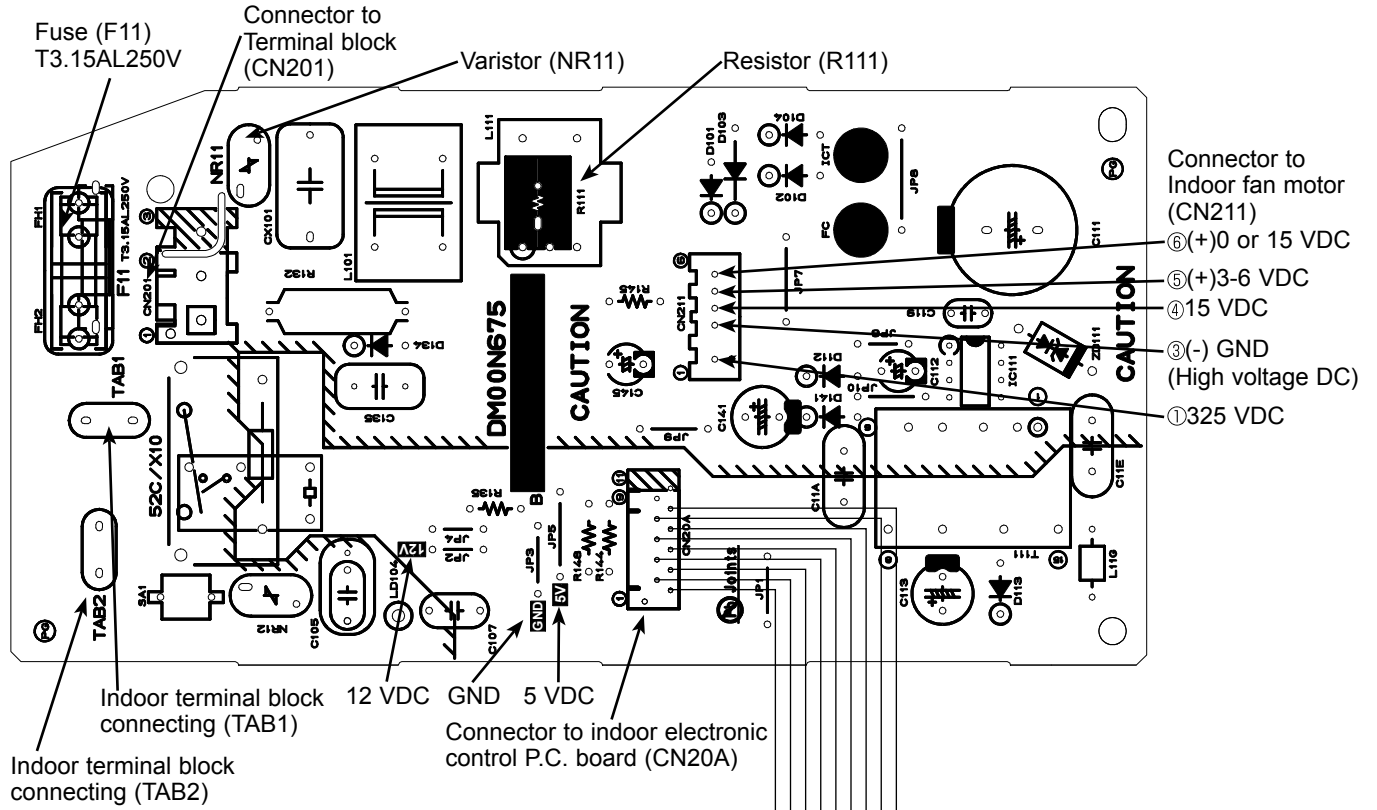

## 2. Indoor electronic control P.C. board

Room temperature thermistor RT11 (CN111)  
To disable "Auto restart function", cut the Jumper wire to JR77.  
(Refer to 8-3.)

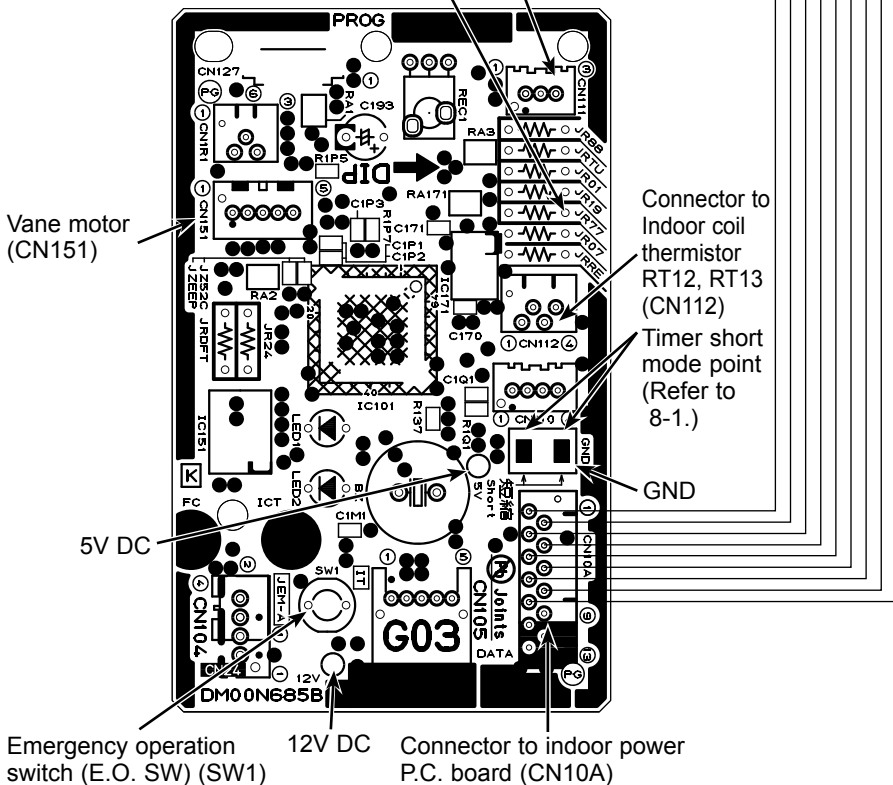

Room temperature thermistor (RT11)  
Indoor coil thermistor (RT12, RT13)

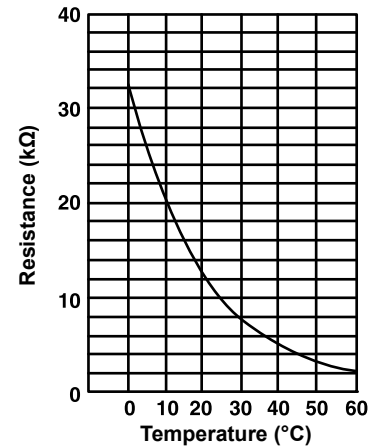

## &lt;"Terminal with locking mechanism" Detaching points&gt;

The terminal which has the locking mechanism can be detached as shown below.

There are 2 types (refer to (1) and (2)) of the terminal with locking mechanism.

The terminal without locking mechanism can be detached by pulling it out.

Check the shape of the terminal before detaching.

(1) Slide the sleeve and check if there is a locking lever or not.

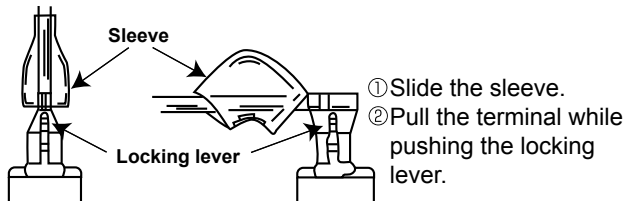

(2) The terminal with this connector has the locking mechanism.

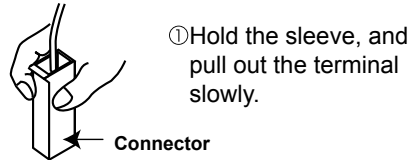

## 11-1. MSZ-DM25VA MSZ-DM35VA

**NOTE:** Turn OFF the power supply before disassembly.

## OPERATING PROCEDURE

## 1. Removing the panel

- (1) Remove the screw caps on the panel and remove the screws of the panel.
- (2) Pull the panel slightly toward you, and then remove the panel by pushing it upward.

## PHOTOS

Photo 1

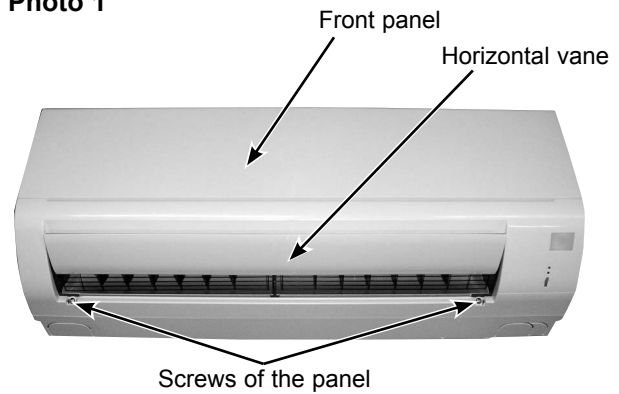

## OPERATING PROCEDURE

### 2. Removing the indoor power P.C. board and the electrical box

(1) Remove the panel. (Refer to 1.) Remove the right corner box.

(2) Disconnect the following connectors:

<Indoor electronic control P.C. board>

CN151 (Vane motor)

CN112 (Indoor coil thermistor)

CN10A (To the indoor power P.C. board)

(3) Unhook the catch on the left side of the control P.C. board holder. Pull the control P.C. board holder as if opening the door at 90 degrees. Remove the control P.C. board holder from the axial rod on the electrical box.

(4) Remove the screw of the V.A. clamp.

(5) Remove the V.A. clamp and the indoor/outdoor connecting wire.

(6) Remove the earth wire connected to the indoor heat exchanger from the electrical box.

(7) Remove the screw of the electrical cover and remove the electrical cover.

(8) Disconnect the following connectors:

<Indoor power P.C. board>

CN211 (Indoor fan motor)

CN201, TAB1, TAB2 (Terminal block)

CN20A (To the indoor electronic control P.C. board)

(9) Remove the upper catch of the electrical box, and pull out the electrical box.

※ To attach the electrical box, pass the wires connecting the indoor power P.C. board and the indoor electronic control P.C. board through A. Pass the lead wires of the fan motor through B as shown in the Photo 3.

## PHOTOS

Photo 2

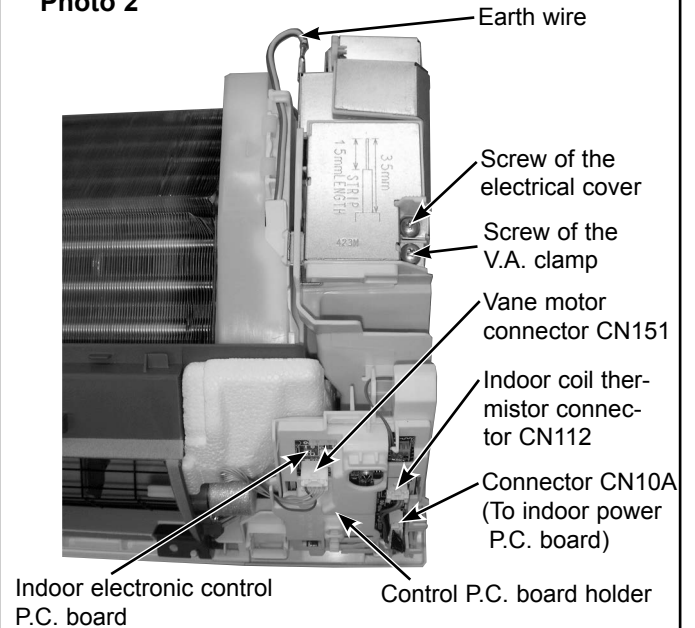
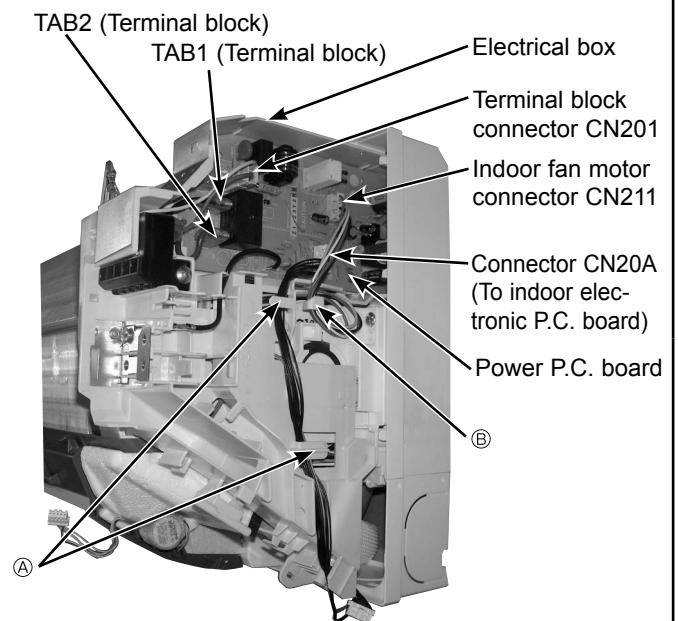

Photo 3



## OPERATING PROCEDURE

### 3. Removing the indoor electronic control P.C. board

- (1) Remove the panel. (Refer to 1.) Remove the right corner box.
- (2) Disconnect the following connectors:  
<Indoor electronic control P.C. board>  
CN151 (Vane motor)  
CN112 (Indoor coil thermistor)  
CN10A (To the indoor power P.C. board)
- (3) Unhook the catch on the left side of the control P.C. board holder. Pull the control P.C. board holder as if opening the door at 90 degrees. Remove the control P.C. board holder from the axial rod on the electrical box.
- (4) Remove the room temperature thermistor from the back side of the control P.C. board holder.
- (5) Unhook the catches of the control P.C. board holder, and open the control P.C. board holder.
- (6) Remove the indoor electronic control P.C. board from the control P.C. board holder.

### 4. Removing the vane motor

- (1) Remove the panel. (Refer to 1.) Remove the corner box.
- (2) Remove the control P.C. board holder and the electrical box. (Refer to 2.)
- (3) Pull out the drain hose from the nozzle assembly and remove the nozzle assembly.
- (4) Remove the screws of the vane motor and remove the vane motor.
- (5) Disconnect the connector from the vane motor.

## PHOTOS

Photo 4

### Control P.C. board holder (Inside)

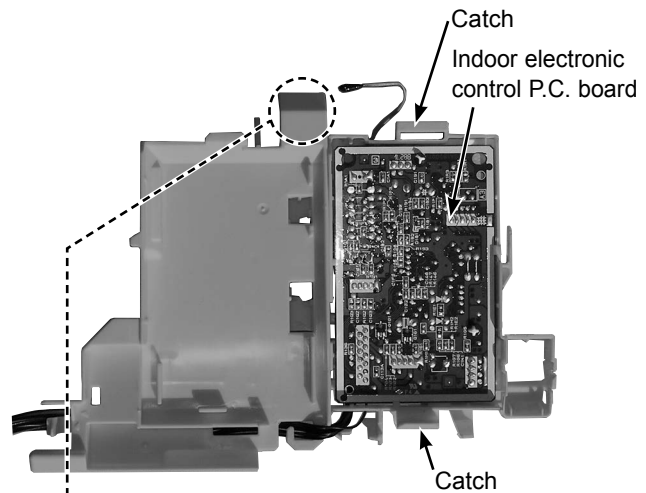

### Control P.C. board holder (Back side)

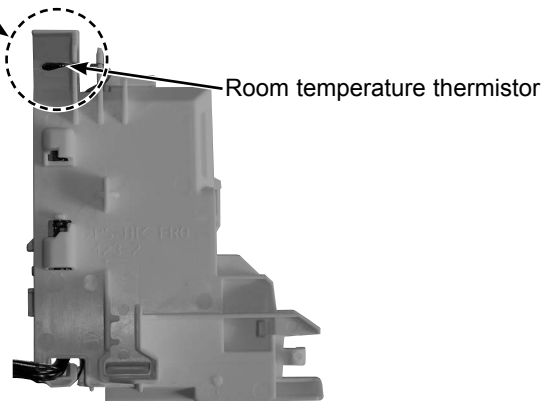
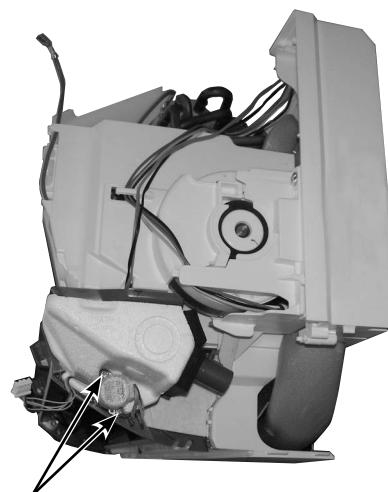

Photo 5



Screws of the vane motor

## OPERATING PROCEDURE

### 5. Removing the indoor fan motor, the indoor coil thermistor and the line flow fan

- (1) Remove the panel. (Refer to 1.) Remove the corner box.
- (2) Remove the control P.C. board holder, the electrical box and the nozzle assembly. (Refer to 2.)
- (3) Remove the screws fixing the motor bed.
- (4) Disengage the hooks of the water cover and remove the water cover.
- (5) Disconnect the earth wire from the motor band.
- (6) Remove the indoor coil thermistor from the motor band.
- (7) Loosen the screw fixing the line flow fan.
- (8) Remove the motor bed together with the indoor fan motor and the motor band.
- (9) Disconnect the lead wire of the fan motor from the motor band.
- (10) Disengage the hooks of the motor band and remove the motor band. Pull out the indoor fan motor.
- (11) Remove the indoor coil thermistor from the heat exchanger.
  - \* Install the indoor coil thermistor in its former position when assembling it.
- (12) Remove the screws fixing the left side of the heat exchanger.
- (13) Lift the heat exchanger, and pull out the line flow fan to the lower-left.

\* When attaching the line flow fan, screw the line flow fan so 4 mm gap is provided between the right end of the line flow fan and the right wall of the air passage of the box (Figure 1).

**Figure 1**

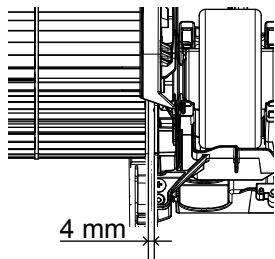

## PHOTOS

**Photo 6**

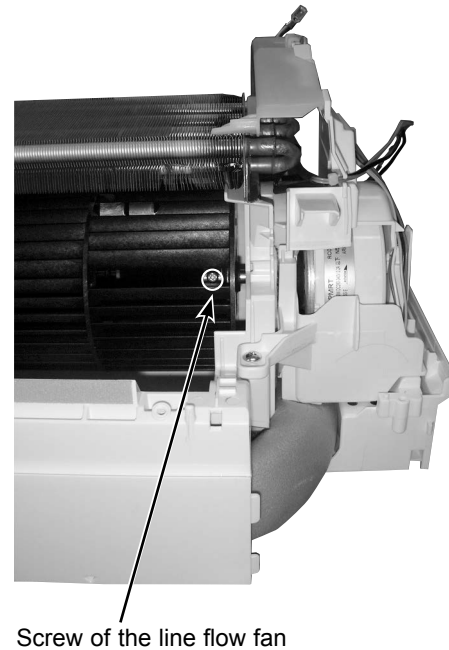

**Photo 7**

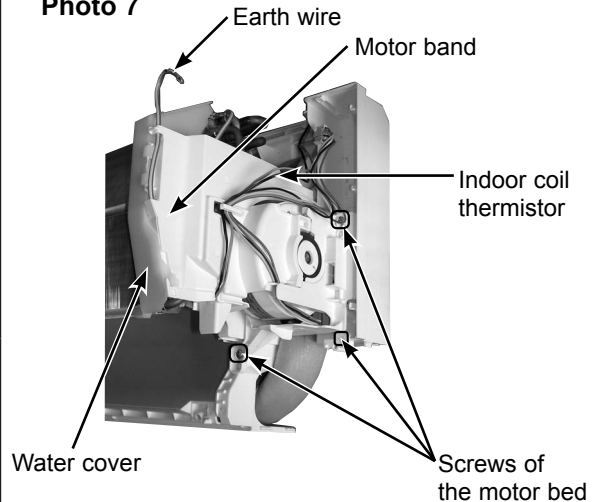

**Photo 8**

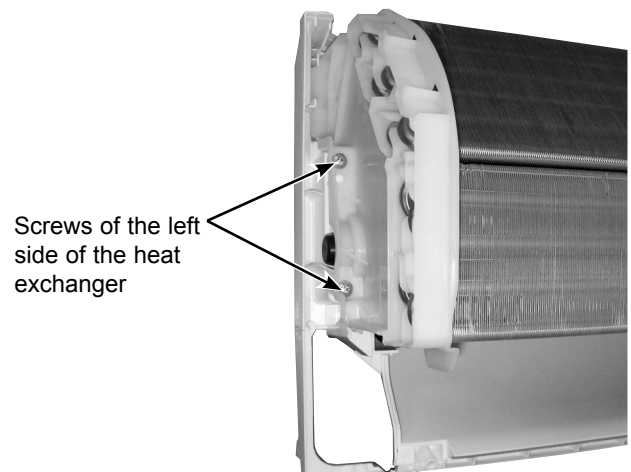

## Fixing the indoor coil thermistor

※ There are 2 forms of parts for fixing the indoor coil thermistor.

**Clip shape**



**Holder shape**



When fixing the indoor coil thermistor to the clip-shape/holder-shape part, the lead wire should point down.

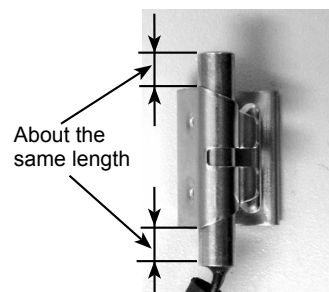

### Position and procedure for mounting the clip-shape part

1. Set the indoor coil thermistor in the center of the clip-shape part.

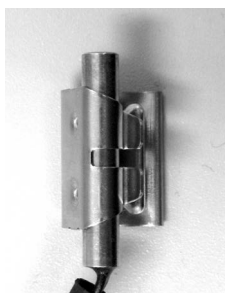

2. Check the (marked) mounting position.



3. Mount the clip-shape part.



#### NOTE:

- Take care to avoid loss and accidental falling of the clip-shape part inside the unit.
- Mount the clip-shape part on the marked position.
- Do not pull the lead wire when removing the indoor coil thermistor.

**MITSUBISHI ELECTRIC CORPORATION**

HEAD OFFICE: TOKYO BLDG., 2-7-3, MARUNOUCHI, CHIYODA-KU, TOKYO 100-8310, JAPAN