

TECSUN

PL-990x

FM STEREO / LW / MW / SW-SSB PLL SYNTHESIZED RECEIVER

•
AUDIO PLAYER

OPERATION MANUAL



TECSUN ELECTRONIC IND. LTD.

CONTENTS

GETTING STARTED

PL-990x at a glance	1
Powering your device	6
Charging the battery	6
Setting the clock	7
Setting the FM frequency range	7
Setting the MW tuning step and AM (MW/LW/SW) frequency range	7
Enabling / Disabling longwave (LW)	8
Settings when using internal/external antennas	8

USING THE DEVICE

Turning the device on/off	9
Volume control	9

(1) LISTENING TO RADIO

VF (View Frequency) and VM (View Memory)	9
Using the radio's antennas	10
Tuning into stations	11
Manual tuning	11
Auto scan	11
Direct keypad entry	11
SW/SSB meter band selection	11
Working with station memories	12
Storing stations manually	12
Auto tuning storage (ATS)	13
Storing stations during auto scan	14
Auto sorting memory	14
Listening to stored stations	15
Recalling stored stations	15
Memory page scan	15
Deleting stored stations	16
Deleting a single station	16
Deleting stations during memory page scan	16
Deleting all stored stations	16

Using the antenna gain [ANT.GAIN] switch	17
AM bandwidth selection	17
Single sideband (SSB)	18
Synchronous detection (SYNC)	18
FM stereo/mono selection	18
Display mode	19
(2) AUDIO PLAYER MODE	19
Playback controls	20
Album preview	21
Selecting an album	21
Selecting an audio track	21
Deleting an audio track	21
(3) COMPUTER SPEAKER MODE	22
(4) OTHER SETTINGS AND FEATURES	22
Activating / Deactivating the alarm	22
Setting the alarm time	22
Setting the alarm by radio or audio player	23
Snooze function	24
Setting the sleep timer	24
Display backlight	25
Keylock	25
Tone selection	25
Using headphones	25
Stereo audio output (line out)	25
MISCELLANEOUS	
Troubleshooting	26
System reset	27
Precautions	28
Maintenance	28
Lithium battery safety instructions	28
PL-990x specifications	29

PL-990x at a Glance - Location of Controls

◀◀ : Previous / replay / rewind

■ : Stop

▶▶ : Play / pause / repeat track

▶▶▶ : Next / fast forward

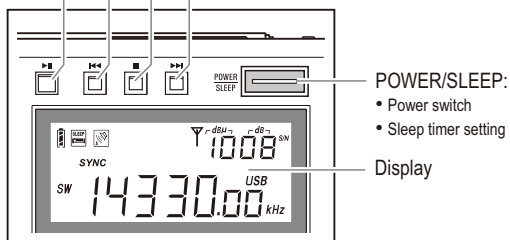

POWER/SLEEP:

- Power switch
- Sleep timer setting

Display

9/10kHz: MW frequency step setting

TIMER A: Alarm setting

TIME: Set time/display time

LW ON/OFF:

Enable/Disable LW

FM SET:

Set FM frequency range

Keypad location guidance light for the visually impaired

M: Store stations

0 - 9: Numeric keys

☰ : Organize memory pages

↵ : Confirm / Delete

TIMER B: Alarm setting

VF/VM: • View Frequency ⇌ View Memory
• Auto scan (frequency/memory)

PAGE -/+ : Select memory page

RADIO/MP3: Radio ⇌ Audio player

FM ST. :
Stereo ⇌ Mono

Band selection/ATS:
FM / MW (AM) / LW / SW

SSB/SYNC:
Single sideband/
synchronous detection

USB: Upper Sideband

LSB: Lower Sideband

METER BAND: SW/SSB meter band selection

AM BANDWIDTH -/+ : AM bandwidth selection

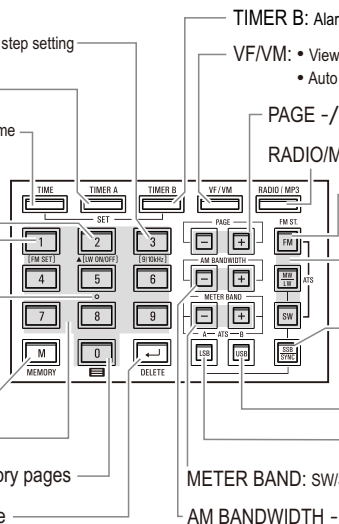

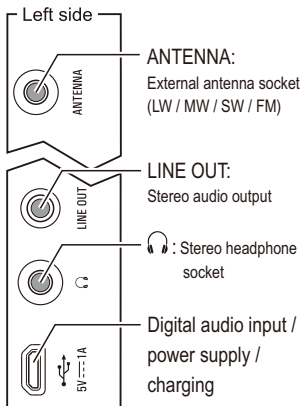
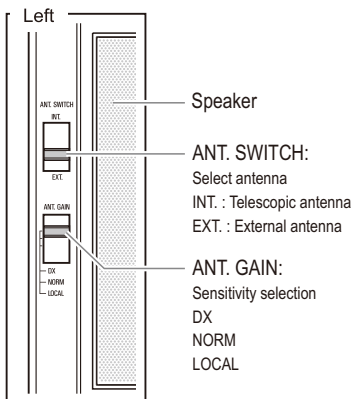
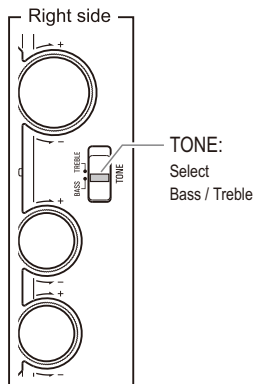
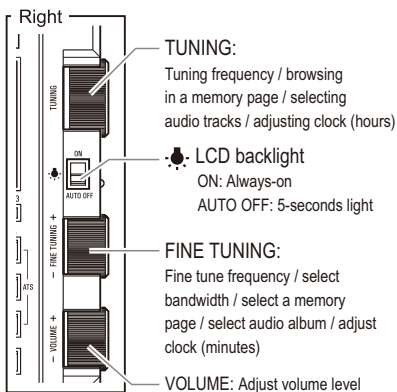

Whip antenna (FM / SW)

SNOOZE: Alarm snooze mode

DISPLAY: Display mode

 : Locks keys and tuning knobs

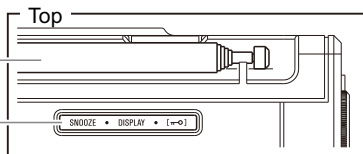

Back

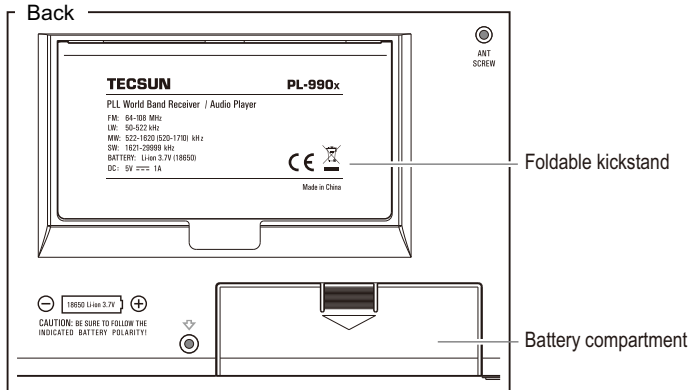

Bottom

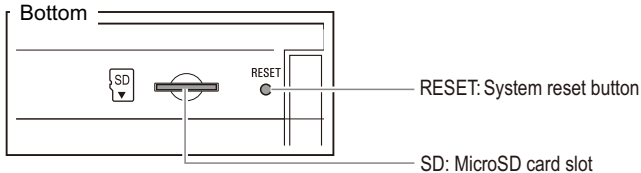

PL-990x at a Glance - Display Indication

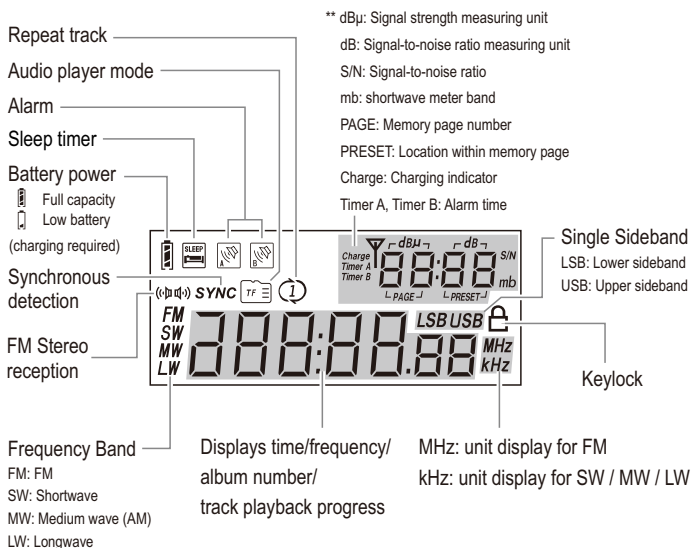

** Display indication examples:

Signal strength / S/N ratio:	 1408 ^{S/N}	Clock time:	20:18
Shortwave meter band:	19 _{mb}	"Timer A":	<small>Timer A</small> 06:30
Memory location:	P232 <small>L-PAGE-J L-PRESET-J</small>	"Timer B":	<small>Timer B</small> 15:30
Organizing memory:	P0C3	Charging time:	<small>Charge</small> 03:20
		Audio track number:	203

Powering Your Device

This device is powered by a 18650 3.7V rechargeable lithium (Li-ion) battery. Open the battery compartment and install the battery following the indicated battery polarity.

Tip: The device can also be powered by connecting a DC 5V/1A power adapter to the power supply socket. Connecting an external power supply causes interference when listening to radio frequencies. If experiencing reception difficulties, disconnect the external power supply and use a battery instead.

Attention! Before using a power adapter, assure that it is appropriately certified and meets the (safety) standards for an adapter in your region.

Charging the Battery

When the battery icon is displayed as “”, this indicates that battery power is about to run out. Charge the battery by connecting a DC 5V/1A charger to the charging socket on the left side of the radio.

While charging the “Charge” indicator flashes and the charging time is displayed at the top right corner of the display. When charging is completed, the battery symbol is displayed as “” and the charging indicator “Charge” stops flashing.

Tips:

- To avoid electrical noise interference, it is recommended not to charge the battery and listen to radio broadcasts at the same time.
- If the device is not used for a prolonged period of time, it is advisable to charge the rechargeable battery once every 3 months for about 4 hours. This may extend battery life.

Setting the Clock (24-hour format):

- 1) Turn the device off.
- 2) Press and hold [TIME] until the clock time starts flashing.
- 3) Use the numeric keys to enter the current time (hours + minutes is four digits). Alternatively, rotate the [TUNING] knob to adjust the hour, then rotate the [FINE TUNING] knob to adjust the minutes, followed by a quick press of the [TIME] button to confirm the setting.

Tip: With the device on, quick press [TIME] to display the current time. Quick press [TIME] again to return to the radio frequency or audio playback display.

Setting the FM Frequency Range

Set the frequency range to correspond with the country in which to use the radio.

- 1) Turn the device off.
- 2) Press and hold the [1] (FM SET) button, the display will show “64”, “76”, “87” or “88” to indicate the corresponding range: 64 ~ 108MHz, 76 ~ 108MHz, 87 ~ 108MHz or 87.5 ~ 108MHz.
- 3) Quick press the [1] button repeatedly to select an appropriate range.
- 4) Quick press [←] to confirm, or wait for 2 seconds for the system to automatically confirm.

Setting the MW Tuning Step and AM (MW/LW/SW) Frequency Range

With the device off, press and hold the [3] (9/10kHz) button to set the tuning step and frequency range of MW that corresponds with the country in which to use the radio.

Display indicates “9”:

- MW tuning steps are set to 9 kHz.
- MW frequency range is 522 ~ 1620 kHz (for Europe, Africa, Asia, Oceania).
- LW frequency range is 50 ~ 522 kHz.
- SW frequency range is 1621 ~ 29999 kHz.

Display indicates “ID”:

- MW tuning steps are set to 10 kHz.
- MW frequency range is 520 ~ 1710 kHz (for North and South America).
- LW frequency range is 100 ~ 519 kHz.
- SW frequency range is 1711 ~ 29999 kHz.

Enabling/Disabling Longwave (LW)

With the device off, press and hold the [2] (LW ON/OFF) button, the display shows “ON” (enabled) or “OFF” (disabled). To select the LW frequency band, power on the device and then quick press the [MW/LW] button twice.

Settings When Using Internal/External Antennas

When using the telescopic whip antenna, push the antenna selector switch [ANT. SWITCH] to “INT.”. When an external antenna is connected to the [ANTENNA] socket, set the selector switch to “EXT.”.

Caution! When using an outdoor antenna, waterproofing and lightning protection measures must be taken.

USING THE DEVICE

Turning the device on/off: Quick press the [POWER/SLEEP] button.

Volume control: Rotate the [VOLUME] knob upwards or downwards to select your desired volume level.

Note: Volume control on this device is disabled when feeding audio through the [LINE OUT] socket.

(1) LISTENING TO RADIO

VF (View Frequency) and VM (View Memory)

VF: VF mode is used when searching for new radio signals. Quick press the [VF/VM] button. When the frequency indicator flashes, the VF mode is activated.

VM: VM mode is used for looking up stations that have been stored into memory. Quick press the [VF/VM] button. When the station memory indicator in the top right corner of the display flashes, the VM mode is activated.

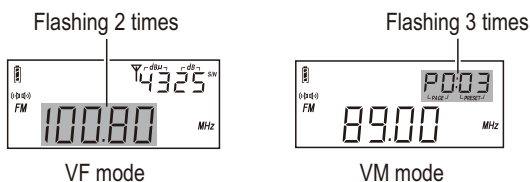

Note: When the memory contains no stored stations, it is not possible to access VM (View Memory) mode.

Using the Radio's Antennas

FM / Shortwave (SW):

When listening to FM or shortwave radio, extend the antenna and adjust its length and direction in order to get the optimum reception.

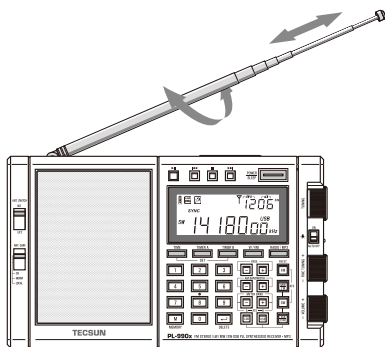

Medium Wave (MW) / Long Wave (LW):

This radio uses an internal ferrite bar antenna to receive medium wave and long wave broadcasts, the quality of which can be enhanced by changing the device's position and direction.

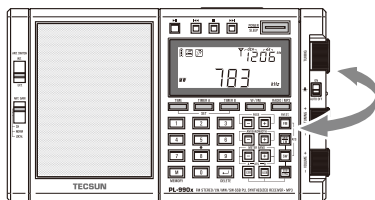

TUNING INTO STATIONS

Turn on the device select your desired frequency band. You can tune into your favorite stations using any of the following tuning methods.

Manual Tuning

In VF mode, rotate the [TUNING] and [FINE TUNING] knobs to search for your desired stations.

Auto Scan

In VF mode, press and hold the [VF/VM] button. The device will automatically scan the entire frequency band for available stations. When a station is found it will stay there for about 5 seconds before continuing the search. To stop the auto scan feature, quick press the [VF/VM] button or gently rotate the [TUNING] knob.

Direct Keypad Entry

In VF mode, quick press the numeric keys [0 - 9] (followed by [←]) to directly enter a station frequency.

Notes:

- For FM band, ignore the decimal point when inputting frequency numbers. For example: enter 8, 9, 3 for FM 89.3 MHz.
- If the entered frequency is not within the covering range, the error “ Err ” symbol will be displayed.

SW / SSB Meter Band Selection

When tuned into a shortwave or SSB frequency, quick press [METER BAND -] or [METER BAND +] to change the SW or SSB meter band:

SW meter bands: 120m / 90m / 75m / 60m / 49m / 41m / 31m / 25m / 22m /
19m / 16m / 15m / 13m / 11m .

SSB meter bands: 160m / 80m / 60m / 40m / 30m / 24m / 20m / 17m / 15m /
12m / 10m .

WORKING WITH STATION MEMORIES

This device can store 3150 stations (presets), separated over 25 memory pages (P0 - P24).

- 1) Page 0, indicated as "P0" on the display, can store 750 stations: 100 stations each for FM, MW, LW, SSB and SYNC, and 250 stations for SW.
- 2) Pages 1-24 ("P1", "P2", etc.) can store 100 stations each for FM, MW, LW and SW.

	Page 0 (P0)	Page 1-24
FM	100 stations	Each memory page can store 100 stations.
MW	100 stations	
LW	100 stations	
SW	250 stations	
SSB	100 stations	X
SYNC	100 stations	X

Storing Stations Manually

- 1) Tune into a radio station.
- 2) Quick press the memory [M] button, "PRESET" flashes and indicates the first available storage location in the selected memory page.

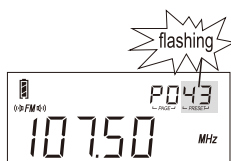

If desired, change the page and/or preset location by using the [PAGE -] or [PAGE +] button and/or the [TUNING] knob.

- 3) Quick press the [M] button again to confirm or wait for about 3 seconds to automatically store the station into memory.

Notes:

- SSB and SYNC stations are only available for storage in Page 0.
- Stored SSB and SYNC station details include USB/LSB and frequency information, but no frequency details smaller than 1 kHz.

Auto Tuning Storage (ATS)

Automatically tune into and store FM, LW, MW and SW stations.

Operation for FM and MW/LW:

- 1) Use the [PAGE -] or [PAGE +] button to select an (empty) memory page.
- 2) Quick press [FM] or [MW/LW] to select the frequency band.
- 3) Press and hold the [FM] or [MW/LW] button until "PRESET" flashes and the frequency starts running.
- 4) When the frequency stops running, it means the ATS operation has been completed. Rotate the [TUNING] knob to view all the stored stations.

Operation for SW:

- 1) Use the [PAGE -] or [PAGE +] button to select an (empty) memory page.
- 2) Quick press [SW] to select the SW frequency band.
- 3) There are two ATS modes for SW:

Mode A: Press and hold the [SW] or [METER BAND -] button to initiate ATS for stations within all meter bands.

Mode B: Press and hold the [METER BAND +] button to initiate ATS within the selected meter band.

Tips:

- ATS (except in SW mode B) replaces previously stored radio stations within a memory page. To prevent this from happening, please select an empty memory page before initiating ATS.
- ATS results for LW, MW and SW strongly depend on radio wave propagation conditions, the receiving environment and other factors. If the results are poor, try to initiate ATS at a different location and/or time, or tune into stations manually and then store them.

Storing Stations During Auto Scan

To avoid any unwanted stations that might be stored during Auto Tuning Storage (ATS), store stations manually during “Auto Scan” (see also page 11).

- 1) Use the [PAGE -] or [PAGE +] button to select a memory page.
- 2) Quick press the [VF/VM] button.
- 3) Quick press the [FM], [MW/LW] or [SW] button to select the frequency band.
- 4) Press and hold the [VF/VM] button. The device will start to scan the entire frequency band for available stations.
- 5) When a station of your liking is found, quick press the memory [M] button to store it; the device continues to scan for the next available station.
- 6) To stop the auto scan feature, quick press the [VF/VM] button or gently rotate the [TUNING] knob.

Auto Sorting Memory

This feature can automatically organize all stations that have been stored into the memory. Turn the device off, and then press and hold the [] button until the memory page number on the display starts running. Duplicate stations are deleted and the remaining stations are organized:

- In memory page P0, stations within a frequency band are sorted in sequence from low to high frequency.
- In memory pages P1-24, stations are sorted in sequence of frequency (from low to high), and in sequence of band: FM, SW, MW, LW.

LISTENING TO STORED STATIONS

When recalling stored stations or initiating a memory page scan, Page 0 (P0) only shows the stations of the frequency band (FM/LW/MW/SW) or mode (SYNC/SSB) that was selected before entering the memory (VM) mode. In Pages 1-24 it is not necessary to preselect a frequency band, the device will show stored stations from all bands within the selected memory page.

Recalling Stored Stations

Operation for memory Page 0:

- 1) Use the [PAGE -] or [PAGE +] button to select memory page P0.
- 2) Select a frequency band (FM, LW, MW, SW) or mode (SYNC, SSB).
- 3) Quick press the [VF/VM] button to enter the VM mode (see also page 9).
- 4) Rotate the [TUNING] knob with some vigor to browse through the station list, or use the numeric keys to directly enter the preset station number.

Operation for memory Page 1-24:

- 1) Use the [PAGE -] or [PAGE +] button to select a memory page.
- 2) Rotate the [TUNING] knob with some vigor to browse through the selected memory page, or use the numeric keys to directly enter the preset station number.

Memory Page Scan

This device can auto scan all stored stations within a memory page, staying on each station for about 5 seconds.

- 1) Use the [PAGE -] or [PAGE +] button to select a memory page.
- 2) Press and hold the [VF/VM] button until "PRESET" flashes in the upper right corner of the display. The device starts to scan all stored stations within the selected memory page.
- 3) To stop scanning, quick press the [VF/VM] button or gently rotate the [TUNING] knob.

DELETING STORED STATIONS

Deleting a Single Station

- 1) Enter the memory (VM) mode and select the station that you wish to delete.
- 2) Press and hold the [←] (DELETE) button until “dEL” and “PRESET” flash on the display.
- 3) Quick press the [←] button to delete the unwanted station.

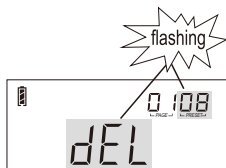

Deleting Stations During Memory Page Scan

This device can auto scan all stored stations within a memory page, staying on each station for about 5 seconds, and giving you the opportunity to delete any unwanted stations.

- 1) Select the memory page from which you wish to delete stored stations (see also page 15 on recalling stored stations).
- 2) Press and hold the [VF/VM] button to start the memory scan.
- 3) Upon finding an unwanted station, press the [←] (DELETE) button. No confirmation is required and scanning continues immediately.
- 4) To stop the memory scan, gently rotate the [TUNING] knob.

Deleting All Stored Stations

To delete all stations within a memory page:

- 1) Select the memory page from which you wish to delete all stored stations.
- 2) Press and hold the [←] (DELETE) button until “dEL” and “PAGE” flash on the display.
- 3) Quick press the [←] button again to confirm.

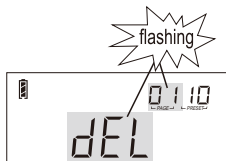

Note: In Page 0, stored stations need to be deleted for each frequency band or mode (SYNC/SSB) separately.

To delete all stations from the memory:

- 1) Turn the device off.
- 2) Press and hold [←] (DELETE) until “dEL” and “ALL” flash on the display.
- 3) Quick press [POWER/SLEEP] to confirm and delete all stored stations.

Note: If the [POWER/SLEEP] button is not pressed for confirmation within 3 seconds, the delete function is exited automatically.

Using the Antenna Gain [ANT.GAIN] Switch

The distance and transmission power of radio stations are not all the same; some received signals will therefore be strong whereas others are weak. To improve the listening experience, sensitivity can be adjusted with the [ANT. GAIN] switch. When listening to distant and weak signal stations, select “DX” to increase sensitivity. When listening to strong (local) signals that seem distorted, select “LOCAL” to avoid strong signal overload blocking.

AM Bandwidth Selection

Quick press [AM BANDWIDTH -/+] repeatedly, or press the button and then rotate the [FINE TUNING] knob, to select different bandwidths to enhance the intelligibility of longwave, medium wave and shortwave signals. Selectable bandwidths are:

LW/MW: 2.3, 3.5, 5.0 and 9.0kHz.

SW: 2.3, 3.5, 5.0 and 6.0kHz.

SSB: 0.5, 1.2, 2.3, 3.0 and 4.0kHz.

- Wide bandwidth: Has better audio fidelity when receiving strong signals or local stations.
- Narrow bandwidth: Limits interference from adjacent strong signals and background noise, thereby especially suitable for receiving weak and distant stations.

Single Sideband (SSB)

When receiving longwave, medium wave and shortwave signals, you can activate the SSB mode to receive particular signals like for example amateur radio communication and Morse Code, but it can also help to mitigate interference.

Enable/Disable SSB mode: Quick press [LSB] (lower sideband) or [USB] (upper sideband) to enable the sideband. Quick press [SSB/SYNC] to disable.

Synchronous Detection (SYNC)

When listening to longwave, medium wave and shortwave broadcasts, turning on synchronous detection may reduce noise interference, eliminate distortion caused by local fading during signal transmission, and suppress interference caused by adjacent stations.

Enable/Disable SYNC detection:

- 1) Press and hold [SSB/SYNC], the display shows “ SYNC ” and the radio enters the synchronous detection mode.
- 2) Quick press [LSB] or [USB] to select Lower Sideband or Upper Sideband SYNC detection.
- 3) To disable, quick press [SSB/SYNC] and “SYNC” disappears from the display.

Note: Enabling the SYNC detector does not always reduce interference.

FM Stereo/Mono Selection

Quick press [FM]. If the FM signal is in stereo the “ (◀▶) ” icon is shown on the display. Quick press [FM] again to return to mono listening.

Notes:

- When the FM signal is broadcasted in mono, or if the station is broadcasted in stereo but the signal is weak, “ (◀▶) ” is not displayed.
- When using the speaker, we recommend listening in mono mode.

Display Mode

When listening to the radio, quick press [SNOOZE ● DISPLAY ● ] repeatedly to select your preferred display mode. The top right corner of the display can show the signal strength/signal-to-noise ratio, alarm time “Timer A”, alarm time “Timer B”, clock time, or the memory location of the frequency (in VM mode only).

(2) AUDIO PLAYER MODE

Insert a microSD card with supported audio files into the card slot at the bottom of the device. Turn the device on. If in radio mode, quick press [RADIO/MP3] to enter the audio player mode.

The display shows “PLAY” and “TF ” and audio playback starts automatically.

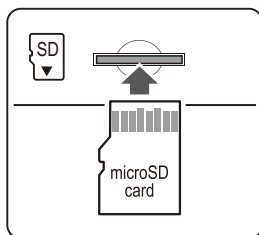

Notes:

- Supported audio formats: 16bit / 44.1kHz, FLAC / WAV / APE / WMA and MP3.
- “- - -” is displayed when there is no card inserted, the card is not supported, or the card does not contain any (supported) files.

Play/Pause: Quick press [▶||]

Restart track: Quick press [I◀◀]

Previous: Quick press [I◀◀] twice, or rotate the [TUNING] knob downwards.

Next: Quick press [▶▶I], or rotate the [TUNING] knob upwards.

Repeat track: Press and hold [▶||] until the display shows “”. Press and hold [▶||] again to resume normal playback.

Rewind: Press and hold [I◀◀]

Fast forward: Press and hold [▶▶I]



Stop: Quick press [■]

Tips: After using [■] to stop playback:

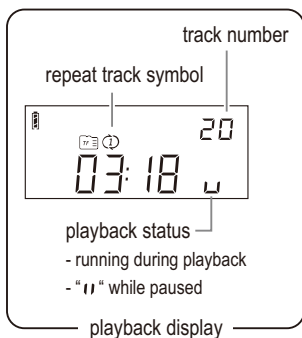
- The display shows the current album number and the total number of tracks in the album.
- Rotate the [TUNING] knob to restart audio playback. The device starts playback from the first track in the selected album.
- Rotate the [FINE TUNING] knob to select a different album and start audio playback.



Album Preview

During playback, quick press [SNOOZE • DISPLAY • ] to display the current album number and the total number of tracks within the album. Quick press [SNOOZE • DISPLAY • ] again to display the total number of albums and the total number of tracks on the microSD card.

Selecting an Album

Method 1: Rotate the [FINE TUNING] knob.

Method 2: Rotate the [FINE TUNING] knob to select the next album, then use the numeric keys to enter an album number and press [] to confirm.

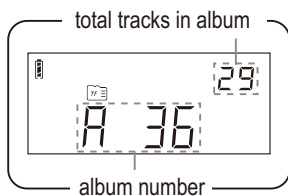



Album Preview Mode

Selecting an Audio Track

Method 1: Rotate the [TUNING] knob or quick press [] / [].

Method 2: Rotate the [TUNING] knob to select the next track, then enter the desired audio track number using the numeric keys and press [] to confirm.

Deleting an Audio Track

- 1) Select the track you want to delete.
- 2) Press and hold [] until the track number and "DEL" flash on the display.
- 3) Quick press [] to confirm and deleted the track.

(3) COMPUTER SPEAKER MODE

You can use this device as a speaker for a computer by following the below steps:

- 1) Turn on the device and quick press [RADIO/MP3] to enter the audio player mode.
- 2) Connect the digital audio input socket (micro-USB type-B) of this device to the computer using a suitable USB data cable. The display shows "PC".
- 3) Turn on the audio player of the computer.

Tips:

- If there is no sound, adjust the sound output settings of your computer, or turn off and restart the computer's audio player.
- You can use the [I◀◀], [▶II], [▶▶I] buttons to control audio playback, and use the [VOLUME] knob and [TONE] switch to adjust volume and treble/bass.

(4) OTHER SETTINGS AND FEATURES

Activating/Deactivating the Alarm

There are two independently programmable alarms to turn on the device at a specific time. Quick press [TIMER A] or [TIMER B] to activate the alarm. The alarm "  " icon is shown on the display to indicate that the device will turn on at the preset time. Quick press again to deactivate the alarm setting.



Setting the Alarm Time

- 1) With the device off, press and hold [TIMER A], the alarm time in the upper right corner of the display will start to flash.
- 2) While still flashing, use the numeric keys to enter the time (4 digits in total). Alternatively, rotate the [TUNING] knob to adjust the hour and the [FINE TUNING] knob to adjust the minutes, followed by [←] to confirm. The duration of the alarm now flashes on the display.





-
- 3) While still flashing, rotate the [TUNING] knob to set the duration after which the device turns off (01 - 60 minutes).
 - 4) Quick press [TIMER A] to confirm the setting. The alarm “” icon is shown on the display. For setting [TIMER B] you can follow the same steps.

Setting the Alarm by Radio or Audio Player

• Alarm by radio

- 1) Turn on the device, select the station frequency you want to use as the alarm.
- 2) Quick press [M], the memory location will flash.
- 3) While still flashing, quick press [TIMER A] or [TIMER B], the alarm “” icon starts flashing.
- 4) While still flashing, quick press [←], “” stops flashing and the setting is completed.
- 5) Make sure to adjust the volume to an appropriate level.

• Alarm by audio player

- 1) Insert a microSD card containing audio files.
- 2) Enter the audio player mode and select the audio track you want to use as the alarm.
- 3) Quick press [M], the “” icon starts flashing.
- 4) While still flashing, quick press [TIMER A] or [TIMER B], the “” and “” icon will flash simultaneously.
- 5) While still flashing, quick press [←], “” and “” stop flashing and the setting is completed.
- 6) Make sure to adjust the volume to an appropriate level.

Tips:

- Once the preset alarm time is reached, the radio turns on and stays on for as long as the alarm duration (01 – 60 minutes) was set. To turn off the device during the alarm playtime, quick press the [POWER/SLEEP] button twice.
- If you wish to change the radio frequency during the alarm playtime, quick press [POWER/SLEEP]. This will deactivate the alarm after which you can adjust the frequency.
- If you wish to choose other audio tracks during the alarm playtime, quick press [POWER/SLEEP]. This will deactivate the alarm after which you can use the audio player normally.

Snooze Function



When the alarm goes off, press [SNOOZE • DISPLAY • ] to temporarily turn off the alarm. The alarm will go off again after 5 minutes. To disable this feature while still snoozing, quick press [POWER/SLEEP].

Setting the Sleep Timer

Use this feature to listen to the radio or audio player and let the device automatically power off after a specified time.

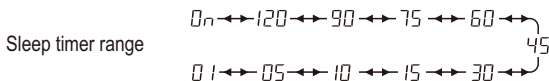
- 1) Turn the device off.
- 2) Press and hold [POWER/SLEEP] to enter the sleep timer setting.
- 3) Rotate the [TUNING] knob to select a power-off timer of 1 - 120 minutes, or select "0n" to deactivate the sleep timer.



- 4) Quick press [] to confirm. The sleep timer " " icon is shown on the display.



Display Backlight

Use the [] switch on the front panel of the device to select your preference:

“ON”: Backlight is set to always-on.

“AUTO OFF”: Backlight turns on when a button or tuning knob is operated and turns off after 5 seconds.

Keylock

To activate the keylock, press and hold [SNOOZE ● DISPLAY ● ]. The lock “” icon is displayed and the buttons and tuning knobs are disabled.

Press and hold [SNOOZE ● DISPLAY ● ] again to unlock.

Tone Selection

Use the [TONE] switch to adjust the “BASS” (lower frequencies) or “TREBLE” (higher frequencies) of the speaker sound.

Using Headphones

Plug a stereo headphone (below 300Ω) into the [] socket.

Stereo Audio Output (Line Out)

To feed audio to external amplifiers, amplified speakers or recording equipment. Use a stereo audio cable with a 3.5 mm (1/8 inch) plug to connect the [LINE OUT] socket of PL-990x to the audio input socket of the external device.

Note: Volume control on this device is disabled while feeding audio through the [LINE OUT] socket.

MISCELLANEOUS - Troubleshooting

ISSUE	POSSIBLE CAUSE / SOLUTION
Unable to power on the device.	Battery has no power or is installed incorrectly. <ul style="list-style-type: none">● Replace or charge the battery.● Take note of the battery placement, then reinstall the battery.
Battery life is short / unable to charge.	The lithium battery is aging. <ul style="list-style-type: none">● Replace with a new battery.
Radio auto turns off while listening.	Battery has no power or the sleep timer is activated. <ul style="list-style-type: none">● Replace or charge the battery.● Deactivate the sleep timer and turn the radio back on.
ATS skips stations, or some stored stations have only noise.	The radio signal is too weak, there is strong interference, or MW (AM) tuning steps are not set accurately. <ul style="list-style-type: none">● Search the station manually.● Adjust the length and direction of the antenna or change to a different location and try again.● MW (AM) stations are spaced at 10 kHz in the Americas. Turn off the device, then press and hold the [3] button to change the tuning step to 10 kHz.
Poor MW (AM) reception while using in North or South America.	MW (AM) stations are spaced at 10 kHz in the Americas, the device may be set to 9 kHz tuning steps. <ul style="list-style-type: none">● Turn off the device, then press and hold the [3] button to change the MW tuning step to 10 kHz.
Only few FM stations can be received.	FM frequency range may not be set correctly for your country. <ul style="list-style-type: none">● Find information about the FM frequency coverage in your country. Turn off the radio, press and hold the [1] button to select a suitable range.
Audio quality is not good when listening to LW, MW (AM) and SW.	The AM bandwidth is set to a narrow band. <ul style="list-style-type: none">● Press the [AM BANDWIDTH +] button repeatedly to change to a wider bandwidth.
When the alarm goes off the radio broadcast is only noise.	Alarm preset radio frequency was not properly set, or there are no broadcasts at that time. <ul style="list-style-type: none">● Assure that receiving a broadcast is possible at the alarm time and the location where the device is placed.● Switch to alarm by audio player instead of radio.

System Reset

This device works on advanced and stable firmware to enhance users' enjoyment. In the event that a sudden firmware glitch does occur (e.g. unresponsive or erratic behavior of buttons/knobs, LCD display issues) press the [RESET] button with a pointy object to return to normal operation; stored stations will not be lost when resetting the firmware.

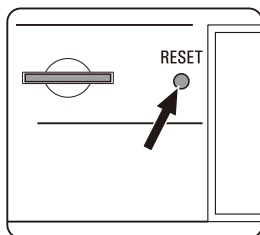

Precautions

Maintenance

- Keep it dry. Rain, humidity and other types of liquids or moisture can contain minerals that may cause corrosion to components. If the device does accidentally get wet, remove the battery and wait for the radio to dry completely before placing it back.
- Do not place or store the device in environments above +45°C. High temperatures can shorten the life span of certain components.
- Do not place or store the device in cold environments below -5°C . Otherwise, once the surrounding temperature rises, internal condensation may develop and damage the circuit board and LCD display.
- Do not drop, hit, or smash the device.
- Do not use harsh chemicals, cleaning solvents, or strong detergents to clean the device. Use a clean, soft, dry cloth to clean the screen.
- Do not attempt to disassemble the device to adjust internal parameters.

Lithium Battery Safety Instructions

- Improper replacement of the lithium battery may result in an explosion. Replace only with a lithium battery of the same type or equivalent (the lithium battery used in this device is a 18650 rechargeable lithium battery with a protection circuit).
- Do not charge non-rechargeable batteries.
- Do not expose the battery to heat sources (e.g. sunlight, fire), low temperatures, humidity, or high pressure.
- Dispose of the battery properly and prevent children from playing with electric currents.
- Do not short-circuit or disassemble the battery. If the battery is seriously inflated, please do not continue to use it.
- If not using for an extended period of time, remove the battery and store it in a safe manner. Please use non-conductive material to wrap the battery in order to avoid direct contact with metal. You can avoid performance loss by keeping the battery in a cool dry place.
- Please consciously abide by aviation regulations; lithium batteries are strictly prohibited from placing into checked luggage.

PL-990x SPECIFICATIONS

Station Memory:	3150 in total
Frequency range:	
LW:	50 ~ 522kHz, 9kHz tuning / 1kHz fine-tuning 100 ~ 519kHz, 9kHz tuning / 1kHz fine-tuning
MW (AM):	522 ~ 1620kHz, 9kHz tuning / 1kHz fine-tuning 520 ~ 1710kHz, 10kHz tuning / 1kHz fine-tuning
SW:	1621 ~ 29999kHz, 5kHz tuning / 1kHz fine-tuning 1711 ~ 29999kHz, 5kHz tuning / 1kHz fine-tuning (When LW, MW and SW are received in SSB mode, the tuning step is 1kHz and the fine-tuning step is 10Hz)
FM:	64 ~ 108MHz, 100kHz tuning / 10kHz fine-tuning 76 ~ 108MHz, 100kHz tuning / 10kHz fine-tuning 87 ~ 108MHz, 100kHz tuning / 10kHz fine-tuning 87.5 ~ 108MHz, 50kHz tuning / 10kHz fine-tuning (tuning step is 50kHz only when MW is set to 9kHz tuning)

Sensitivity:

LW (S/N=26dB)	< 3mV/m
MW (S/N=26dB)	< 1mV/m
SW (S/N=26dB)	< 20 μ V
FM (S/N=30dB)	< 3 μ V
SSB (S/N=10dB)	< 1 μ V

Selectivity:

LW/MW	> 40dB
SW	> 40dB
FM	> 65dB

SYNC Lock Range: +/- 1kHz

S/N Ratio:

LW/MW	> 40dB
SW	> 45dB
FM	> 60dB

IF Frequency:

AM: 1st IF: 55.845MHz, 2nd IF: 10.7MHz, 3rd IF (DSP): 45kHz

FM: 128kHz

FM Stereo Crosstalk: 35dB

Output Power: $\geq 450\text{mW}$ (at 10% harmonic distortion)

Quiescent Current:

MW / LW $< 75\text{mA}$

SW $< 90\text{mA}$

SSB $< 90\text{mA}$

FM $< 35\text{mA}$

Audio Player Approx. 60mA

Shutdown Current: 120 μA

MicroSD Card: Max. 128GB

Supported Audio: 16bit / 44.1kHz; FLAC / WAV / APE / WMA / MP3

Speaker: 4 Ω , 3W

Headphone Input: 3.5mm / $< 300\Omega$

Power Supply: 3.7V (18650 Li-ion battery x 1) or external DC 5V

Charger / Power: 5V --- 1A, micro-USB type-B socket

Dimensions: 198 (W) x 120 (H) x 38 (D) mm

Weight (excl. battery): 611g

TECSUN

TECSUN ELECTRONIC IND. LTD.

Address: Unit 11, 13/F, Block A, Hoi Luen Ind. Ctr., 55 Hoi Yuen Road,
Kwun Tong, Kowloon, Hong Kong.

E-mail: tecsun@on-nets.com

Website: www.tecsun.com.cn www.tecsun-audio.com

V130820