

Single Synchronous Buck Controller

General Description

The RT8202L/M PWM controller provides the high efficiency, excellent transient response, and high DC output accuracy needed for stepping down high voltage batteries to generate low voltage CPU core, I/O, and chipset RAM supplies in notebook computers.

The constant-on-time PWM control scheme handles wide input/output voltage ratios with ease and provides 100ns “instant-on” response to load transients while maintaining a relatively constant switching frequency.

The RT8202L/M achieves high efficiency at a reduced cost by eliminating the current-sense resistor found in traditional current mode PWMs. Efficiency is further enhanced by its ability to drive very large synchronous rectifier MOSFETs. The RT8202L is available in a WQFN-16L 4x4 package and the RT8202M is available in a WQFN-16L 3x3 package.

Ordering Information

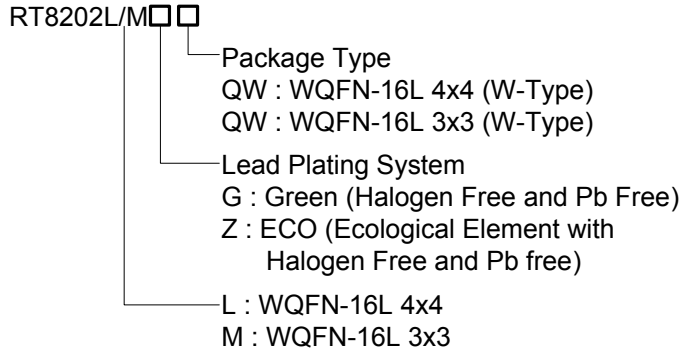

Note :

Richtek products are :

- ▶ RoHS compliant and compatible with the current requirements of IPC/JEDEC J-STD-020.
- ▶ Suitable for use in SnPb or Pb-free soldering processes.

Features

- Ultra-High Efficiency
- Resistor Programmable Current Limit by Low Side $R_{DS(ON)}$ Sense (Lossless Limit)
- 4700ppm/°C $R_{DS(ON)}$ Current Sensing
- Quick Load Step Response within 100ns
- 1% V_{FB} Accuracy over Line and Load
- Adjustable 0.75V to 3.3V Output Voltage Range
- 3V to 26V Battery Input Voltage Range
- Resistor Programmable Frequency
- Integrated Bootstrap Switch
- Over Voltage Protection
- Under Voltage Protection
- Voltage Ramp Soft-Start
- Built In Soft Discharge Output
- Power Good Indicator
- RoHS Compliant and 100% Halogen Free

Applications

- Notebook Computers
- CPU Core Supply
- Chipset/RAM Supply as Low as 0.75V

Pin Configurations

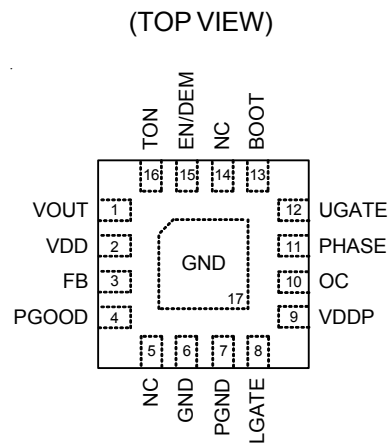

WQFN-16L 4x4 (RT8202L)
WQFN-16L 3x3 (RT8202M)

Marking Information

RT8202LGQW

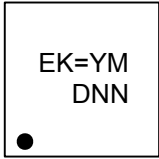

EK= : Product Code
YMDNN : Date Code

RT8202MGQW

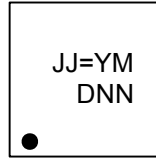

JJ= : Product Code
YMDNN : Date Code

RT8202LZQW

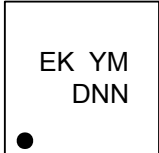

EK : Product Code
YMDNN : Date Code

RT8202MZQW

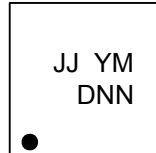

JJ : Product Code
YMDNN : Date Code

Typical Application Circuit

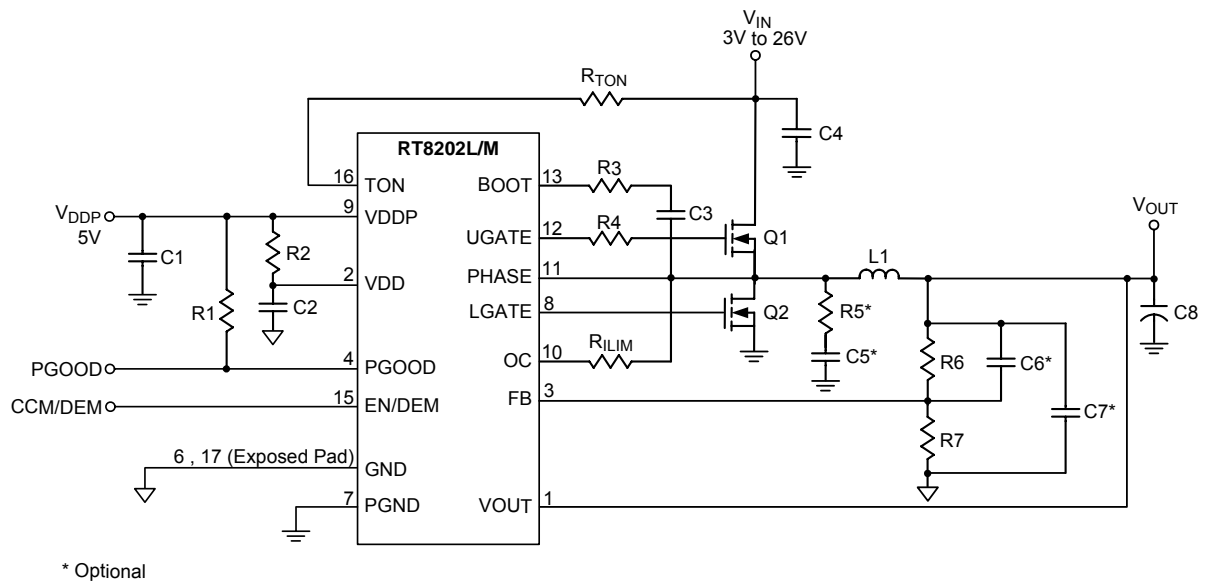

Function Block Diagram

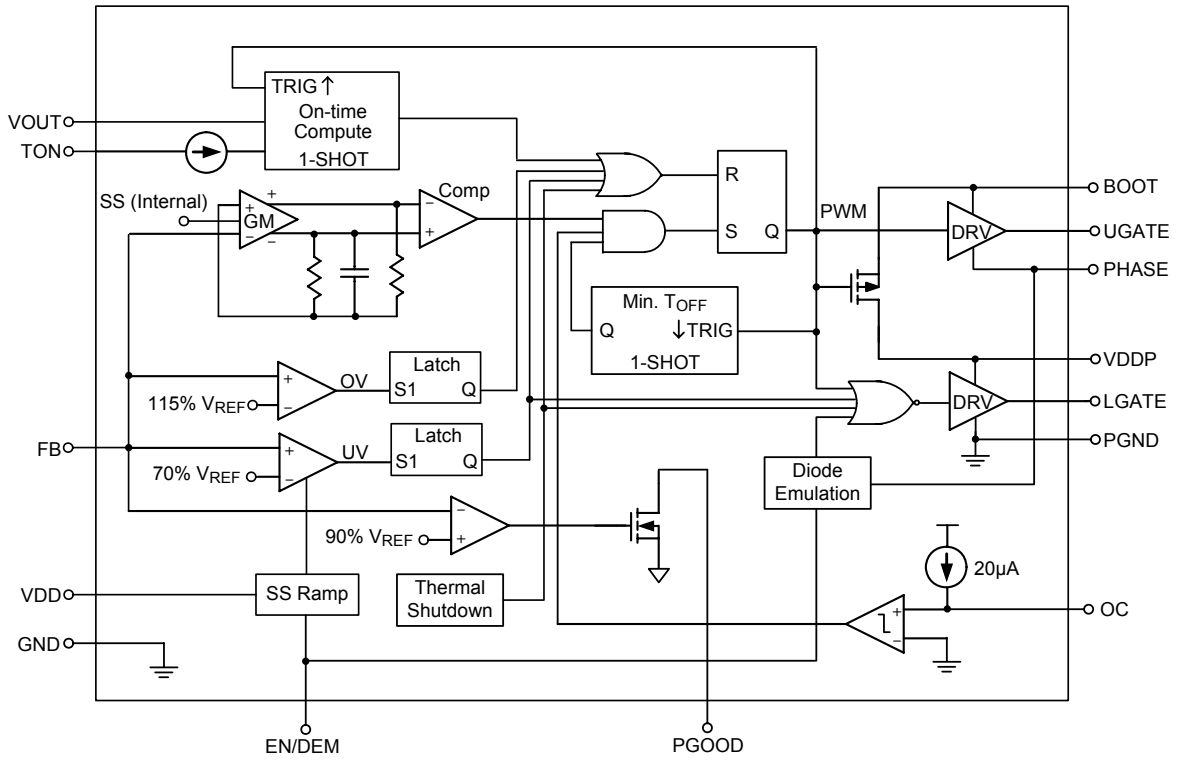

Functional Pin Description

Pin No.	Pin Name	Pin Function
1	VOUT	Output Voltage Sense Pin. Connect this pin to the output of PWM converter. VOUT is also for the output soft discharge when shutdown.
2	VDD	Analog Supply Voltage Input for Internal Analog Integrated Circuit. Bypass this pin to GND with a 1 μ F ceramic capacitor.
3	FB	Feedback Input of PWM Controller. Connect FB to a resistor voltage divider from VOUT to GND to adjust the output voltage from 0.75V to 3.3V.
4	PGOOD	Power Good Signal Open-Drain Output of PWM Controller. This pin will be pulled high when the output voltage is within the target range.
5, 14	NC	No Internal Connection.
6, 17 (Exposed Pad)	GND	Analog Ground. The exposed pad must be soldered to a large PCB and connected to GND for maximum power dissipation.
7	PGND	Power Ground.
8	LGATE	Low Side N-MOSFET Gate-Drive Output for PWM. This pin swings between PGND to VDDP.
9	VDDP	Gate Driver Supply for External MOSFETs. Bypass this pin to PGND with a 1 μ F ceramic capacitor.
10	OC	PWM Current Limit Setting and Sense. Connect a resistor between OC to PHASE for current limit setting.
11	PHASE	Inductor Connection. This pin is not only the zero-current-sense input for the PWM converter, but also the UGATE high side gate driver return.
12	UGATE	High Side N-MOSFET Floating Gate-Driver Output for PWM controller. This pin swings between PHASE and BOOT.
13	BOOT	Boost Capacitor connection for PWM Controller. Connect an external ceramic capacitor from this pin to PHASE.
15	EN/DEM	PWM Enable and Operation Mode Selection Input. Connect this pin to VDD for diode-emulation mode, connect this pin to GND for shutdown mode and floating the pin for CCM mode.
16	TON	On Time/Frequency Adjustment Pin. Connect this pin to V _{IN} through a resistor. TON is an input of the PWM controller.

Absolute Maximum Ratings (Note 1)

• Input Voltage, TON to GND	-----	-0.3V to 32V
• BOOT to PHASE	-----	-0.3V to 6V
• UGATE to PHASE		
DC	-----	-0.3V to 6V
< 20ns	-----	-5V to 7.5V
• LGATEx to GND		
DC	-----	-0.3V to 6V
< 20ns	-----	-2.5V to 7.5V
• PHASE to GND		
DC	-----	-0.3V to 32V
< 20ns	-----	-8V to 38V
• PGND to GND	-----	-0.3V to 0.3V
• VDD, VDDP, VOUT, EN/DEM, FB, PGOOD to GND	-----	-0.3V to 6V
• OC to GND	-----	-0.3V to 28V
• Power Dissipation, $P_D @ T_A = 25^\circ\text{C}$		
WQFN-16L 3x3	-----	1.471W
WQFN-16L 4x4	-----	1.852W
• Package Thermal Resistance (Note 2)		
WQFN-16L 3x3, θ_{JA}	-----	68°C/W
WQFN-16L 3x3, θ_{JC}	-----	7.5°C/W
WQFN-16L 4x4, θ_{JA}	-----	54°C/W
WQFN-16L 4x4, θ_{JC}	-----	7°C/W
• Lead Temperature (Soldering, 10 sec.)	-----	260°C
• Junction Temperature	-----	150°C
• Storage Temperature Range	-----	-65°C to 150°C
• ESD Susceptibility (Note 3)		
HBM (Human Body Mode)	-----	2kV
MM (Machine Mode)	-----	200V

Recommended Operating Conditions (Note 4)

• Input Voltage, V_{IN}	-----	3V to 26V
• Supply Voltage, V_{DD}, V_{DDP}	-----	4.5V to 5.5V
• Junction Temperature Range	-----	-40°C to 125°C
• Ambient Temperature Range	-----	-40°C to 85°C

Electrical Characteristics

($V_{DD} = V_{DDP} = 5V$, $V_{IN} = 15V$, $V_{EN/DEM} = V_{DD}$, $R_{TON} = 1M\Omega$, $T_A = 25^\circ C$, unless otherwise specified)

Parameter	Symbol	Test Conditions	Min	Typ	Max	Unit
Quiescent Current	I_Q	$V_{DD} + V_{DDP}$, $V_{FB} = 0.8V$, forced above the regulation point	--	--	1250	μA
TON Operating Current			--	15	--	μA
Shutdown Current	I_{SHDN}	$V_{DD} + V_{DDP}$	--	1	10	
		I_{TON}	--	1	5	
		EN/DEM = 0V	-10	-1	--	μA
FB Reference Voltage	V_{FB}	$V_{DD} = 4.5V$ to $5.5V$	0.742	0.75	0.758	V
FB Input Bias Current		$V_{FB} = 0.75V$	-1	0.1	1	μA
Output Voltage Range	V_{OUT}		0.75	--	3.3	V
On-Time	t_{ON}	$V_{IN} = 15V$, $V_{OUT} = 1.25V$	267	334	401	ns
Minimum Off-Time	t_{OFF}		250	400	550	ns
VOUT Shutdown Discharge Resistance		EN/DEM = GND, $V_{OUT} = 0.5V$	--	20	--	Ω
Current Sensing						
Current Limit Source Current		LGATE = High	18	20	22	μA
Current Limiter Temperature Coefficient	TC_{ICS}	On the basis of $25^\circ C$	--	4700	--	ppm/ $^\circ C$
Current Comparator Offset Voltage		GND to OC	-10	--	10	mV
Zero Crossing Threshold Voltage		PHASE to GND, EN/DEM = 5V	-10	--	5	mV
Fault Protection						
Current Limit Sense Voltage		GND – PHASE, $R_{LIM} = 10k\Omega$	170	200	230	mV
Output Under Voltage Threshold	V_{UVP}	UVP detect, FB falling edge	60	70	80	%
Over Voltage Protection Threshold	V_{OVP}	OVP detect, FB rising edge	110	115	120	%
Over Voltage Fault Delay		FB forced above over voltage threshold	--	20	--	μs
Under Voltage Lockout Threshold	V_{UVLO}	Falling edge, PWM disabled below this level	3.7	3.9	4.1	V
Under Voltage Lockout Hysteresis	ΔV_{UVLO}		--	150	--	mV
Soft-Start Ramp Time	t_{SS}	From EN high to internal VREF reaches 0.71V (0→95%)		1.5	--	ms
Under Voltage Blank Time		From EN signal going high	--	4.5	--	ms
Thermal Shutdown	T_{SD}		--	155		$^\circ C$
Thermal Shutdown Hysteresis	ΔT_{SD}		--	10	--	$^\circ C$
Driver On-Resistance						
UGATE Driver Source	$R_{UGATEsr}$	UGATE, High State, BOOT to PHASE forced to 5V	--	2	--	Ω
UGATE Driver Sink	$R_{UGATEsk}$	UGATE, Low State, BOOT to PHASE forced to 5V	--	1.5	--	Ω

To be continued

Parameter	Symbol	Test Conditions	Min	Typ	Max	Unit
LGATE Driver Source	$R_{LGATEsr}$	LGATE, High State	--	1.5	--	Ω
LGATE Driver Sink	$R_{LGATEsk}$	LGATE, Low State	--	0.7	--	Ω
Internal BOOT Charging Switch On-Resistance		VDDP to BOOT, 10mA	--	--	90	Ω
Dead Time		LGATE Rising ($V_{PHASE} = 1.5V$)	--	30	--	ns
		UGATE Rising	--	30	--	
Logic I/O						
Logic Input Voltage		EN/DEM Low	--	--	0.8	V
		EN/DEM High	2.9	--	--	
		EN/DEM Float	--	2	--	
Logic Input Current		EN/DEM = VDD	--	1	10	μA
		EN/DEM = 0	-10	1	--	
PGOOD (upper side threshold decide by OV threshold)						
Trip Threshold (falling)		Measured at FB, with respect to reference, Hysteresis = 3%	87	90	93	%
Fault Propagation Delay		Falling edge, FB forced below PGOOD trip threshold	--	2.5	--	μs
Output Low Voltage		$I_{SINK} = 1mA$	--	--	0.4	V
Leakage Current		High state, forced to 5V	--	--	1	μA

Note 1. Stresses listed as the above "Absolute Maximum Ratings" may cause permanent damage to the device. These are for stress ratings. Functional operation of the device at these or any other conditions beyond those indicated in the operational sections of the specifications is not implied. Exposure to absolute maximum rating conditions for extended periods may remain possibility to affect device reliability.

Note 2. θ_{JA} is measured in natural convection at $T_A = 25^\circ C$ on a high effective thermal conductivity four-layer test board of JEDEC 51-7 thermal measurement standard. The case measurement position of θ_{JC} is on the exposed pad of the package.

Note 3. Devices are ESD sensitive. Handling precaution is recommended.

Note 4. The device is not guaranteed to function outside its operating conditions.

Typical Operating Characteristics

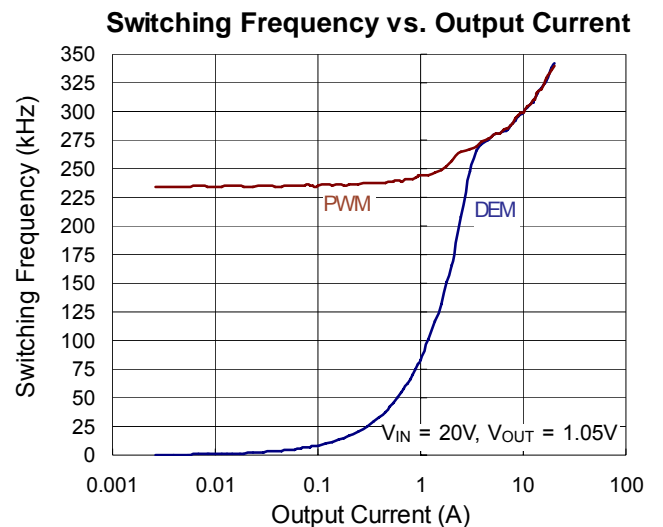
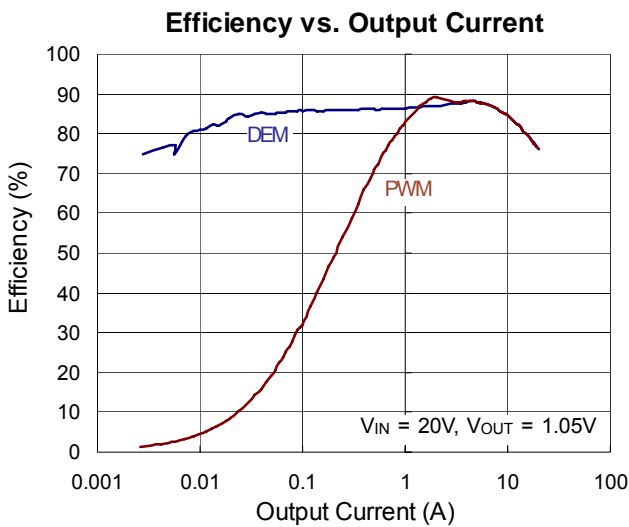
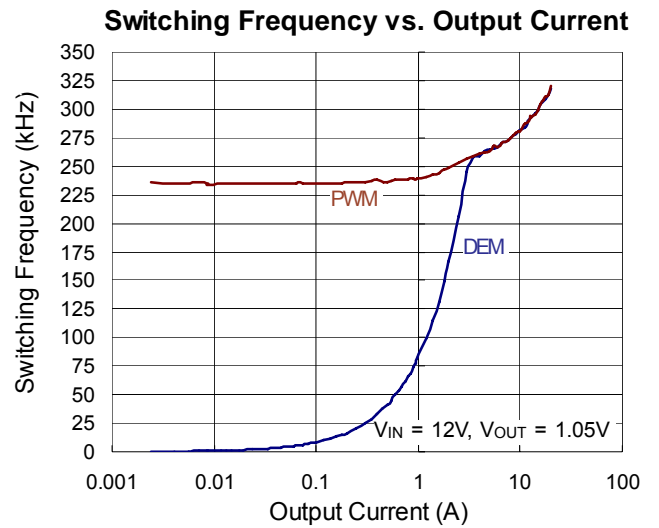
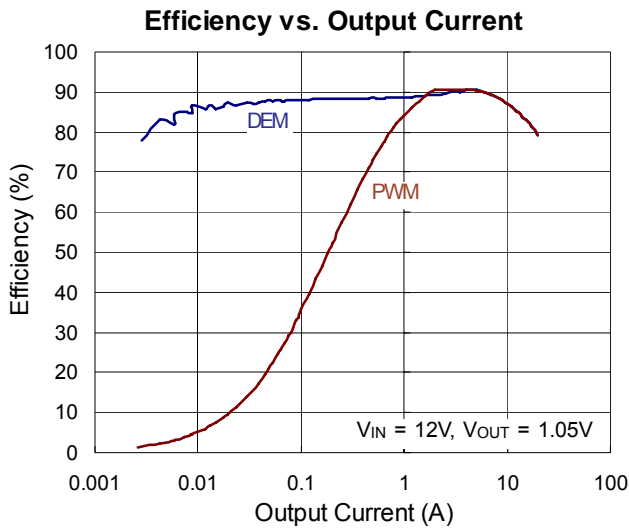
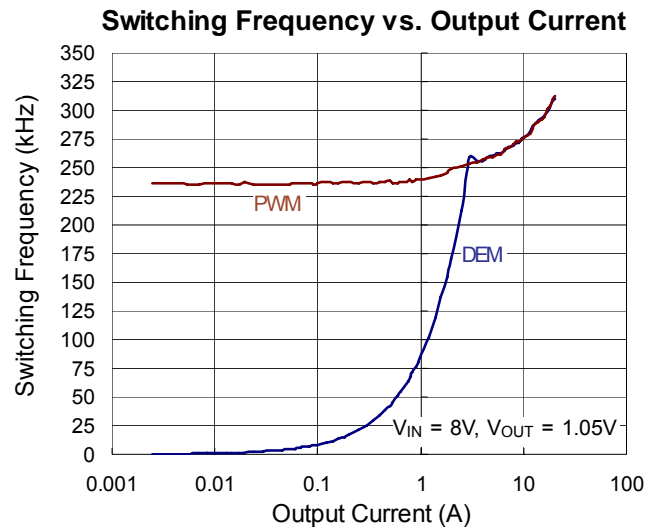
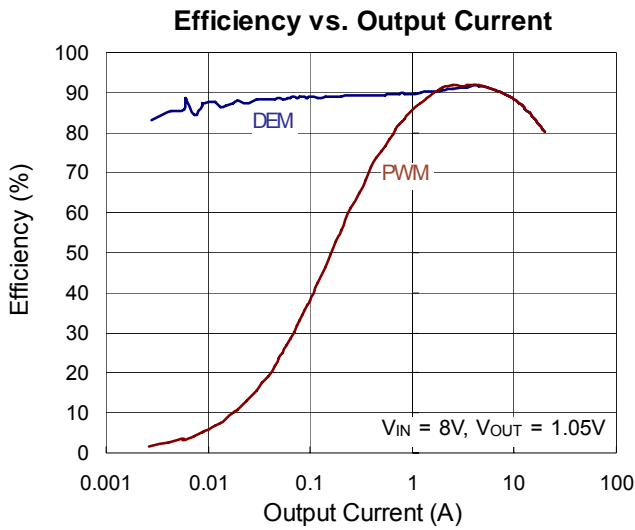

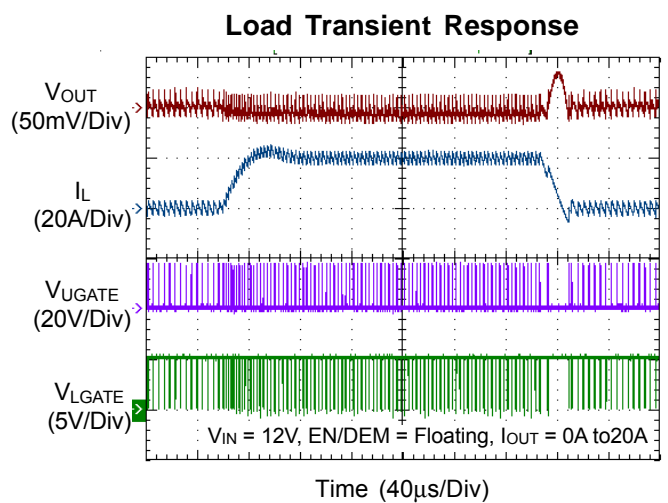
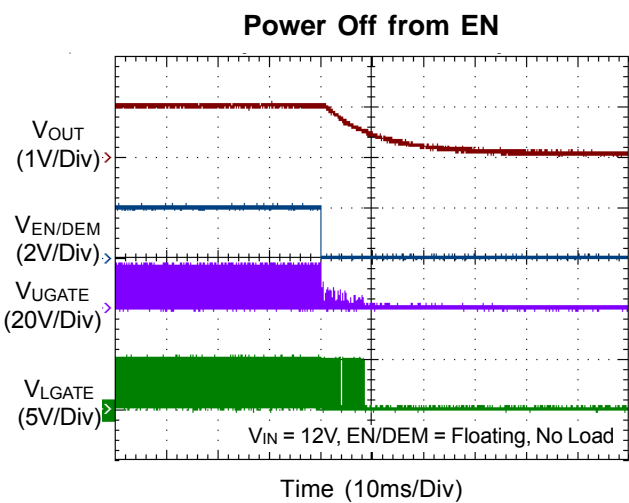
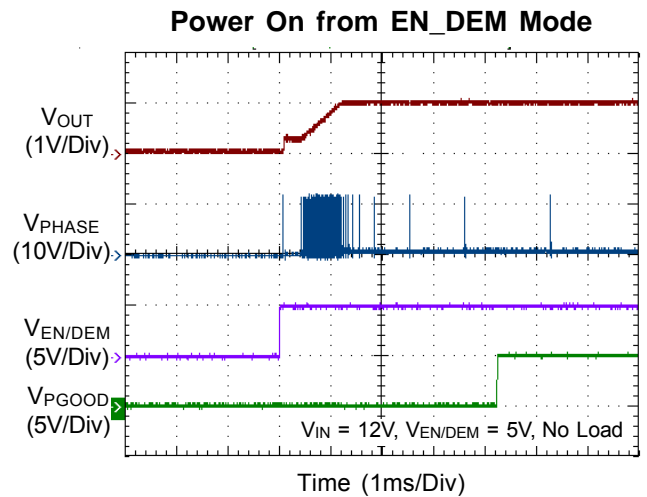
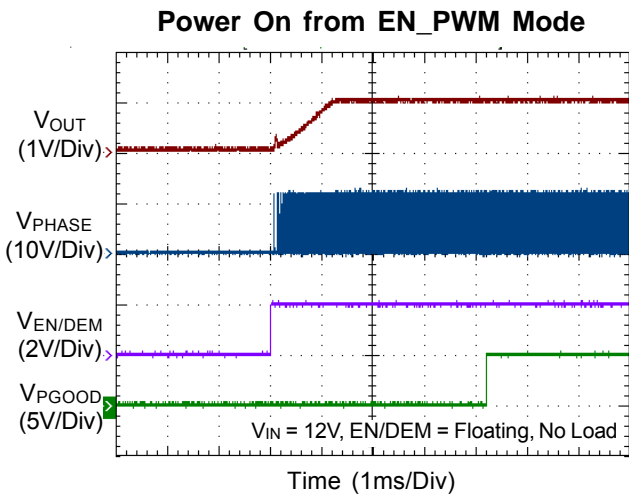
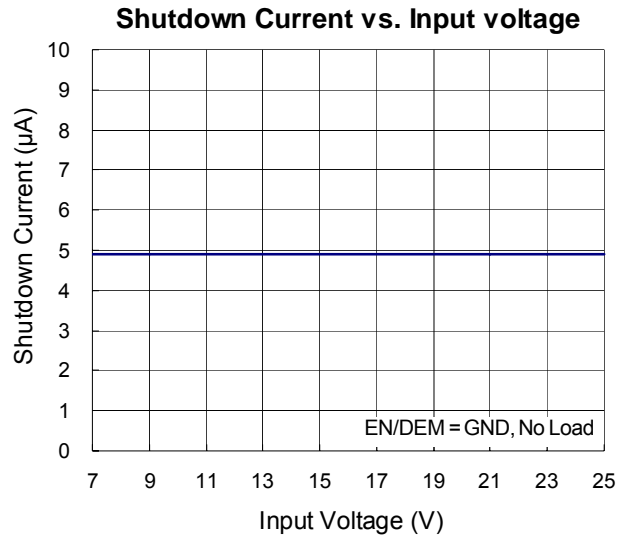
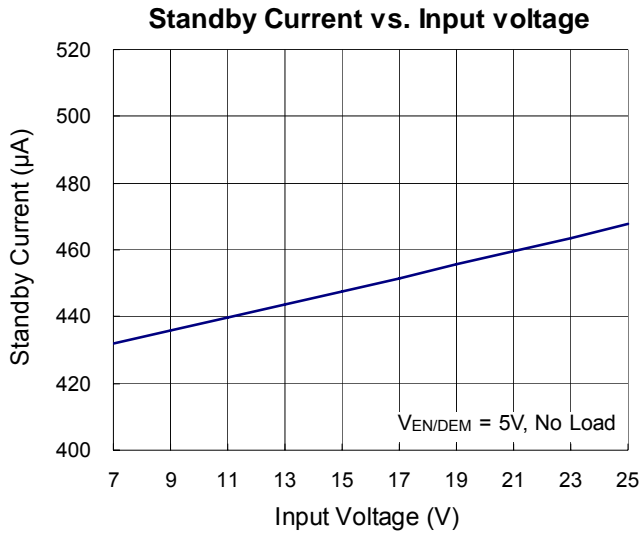

Over Voltage Protection

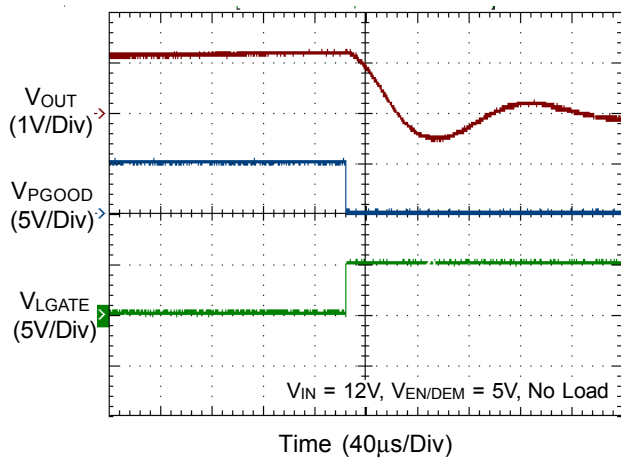

Under Voltage Protection

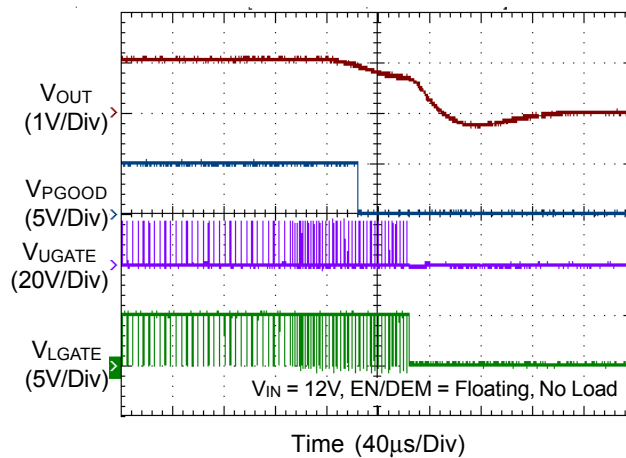

Applications Information

The RT8202L/M PWM controller provides the high efficiency, excellent transient response, and high DC output accuracy needed for stepping down high voltage batteries to generate low voltage CPU core, I/O, and chipset RAM supplies in notebook computers. RichTek's Mach Response™ technology is specifically designed for providing 100ns "instant-on" response to load steps while maintaining a relatively constant operating frequency and inductor operating point over a wide range of input voltages. The topology circumvents the poor load transient timing problems of fixed frequency current mode PWMs while also avoiding the problems caused by widely varying switching frequencies in conventional constant-on-time and constant-off-time PWM schemes. The DRV™ mode PWM modulator is specifically designed to have better noise immunity for such a single output application.

PWM Operation

The Mach Response™ DRV™ mode controller relies on the output filter capacitor's effective series resistance (ESR) to act as a current-sense resistor, so the output ripple voltage provides the PWM ramp signal. Referring to the function diagrams of the RT8202L/M, the synchronous high side MOSFET is turned on at the beginning of each cycle. After the internal one-shot timer expires, the MOSFET is turned off. The pulse width of this one shot is determined by the converter's input and output voltages to keep the frequency fairly constant over the input voltage range. Another one-shot sets a minimum off-time (400ns typ.).

On-Time Control (TON)

The on-time one-shot comparator has two inputs. One input looks at the output voltage, while the other input samples the input voltage and converts it to a current. This input voltage proportional current is used to charge an internal on-time capacitor. The on-time is the time required for the voltage on this capacitor to charge from zero volts to V_{OUT}, thereby making the on-time of the high side switch directly proportional to the output voltage and inversely proportional to the input voltage. The implementation results in a nearly constant switching frequency without the need of a clock generator.

$$t_{ON} = \frac{3.85p \times R_{TON} \times V_{OUT}}{(V_{IN} - 0.5)}$$

And then the switching frequency is :

$$\text{Frequency} = \frac{V_{OUT}}{(V_{IN} \times t_{ON})}$$

R_{TON} is a resistor connected from the input supply (V_{IN}) to the TON pin.

Mode Selection (EN/DEM) Operation

The EN/DEM pin enables the supply. When EN/DEM is tied to VDD, the controller is enabled and operates in diode-emulation mode. When the EN/DEM pin is floating, the RT8202L/M will operate in forced-CCM mode.

Diode-Emulation Mode (EN/DEM = High)

In diode-emulation mode, the RT8202L/M automatically reduces switching frequency at light load conditions to maintain high efficiency. This reduction of frequency is achieved smoothly and without increasing V_{OUT} ripple or load regulation. As the output current decreases from heavy-load condition, the inductor current is also reduced, and eventually comes to the point when its valley touches zero current, which is the boundary between continuous conduction and discontinuous conduction modes. By emulating the behavior of diodes, the low side MOSFET allows only partial negative current when the inductor freewheeling current becomes negative. As the load current is further decreased, it takes longer and longer to discharge the output capacitor to the level that requires the next "ON" cycle. The on-time is kept the same as that in the heavy-load condition. In reverse, when the output current increases from light load to heavy load, the switching frequency increases to the preset value as the inductor current reaches the continuous condition. The transition load point to the light load operation can be calculated as follows (Figure 1) :

$$I_{LOAD} \approx \frac{(V_{IN} - V_{OUT})}{2L} \times t_{ON}$$

where t_{ON} is the On-time.

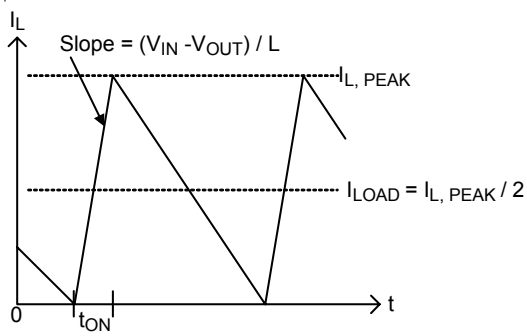

Figure 1. Boundary Condition of CCM/DEM

The switching waveforms may appear noisy and asynchronous when light loading causes diode-emulation operation, however, this is a normal operating condition that results in high light load efficiency. Trade-offs in DEM noise vs. light load efficiency are made by varying the inductor value. Generally, low inductor values produce a broader efficiency vs. load curve, while higher values result in higher full load efficiency (assuming that the coil resistance remains fixed) and less output voltage ripple. The disadvantages for using higher inductor values include larger physical size and degraded load transient response (especially at low input voltage levels).

Forced-CCM Mode (EN/DEM = floating)

The low noise, forced-CCM mode (EN/DEM = floating) disables the zero crossing comparator, which controls the low side switch on-time. This causes the low side gate-drive waveform to become the complement of the high side gate-drive waveform. This in turn causes the inductor current to reverse at light loads as the PWM loop to maintain a duty ratio V_{OUT}/V_{IN} . The benefit of forced-CCM mode is to keep the switching frequency fairly constant, but it comes at a cost. The no load battery current can be as high as 10mA to 40mA, depending on the external MOSFETs.

Current Limit Setting (OCP)

The RT8202L/M has a cycle-by-cycle current limiting control. The current limit circuit employs a unique “valley” current sensing algorithm. If the magnitude of the current sense signal at OC is above the current limit threshold, the PWM is not allowed to initiate a new cycle (Figure 2).

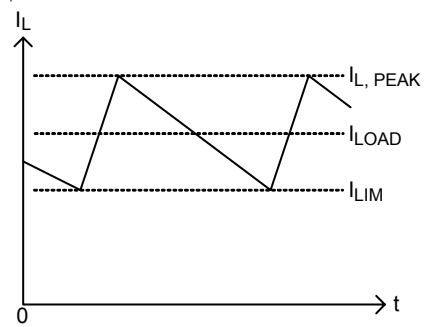

Figure 2. Valley Current Limit

Current sensing of the RT8202L/M can be accomplished in two ways. Users can either use a current sense resistor or the on-state of the low side MOSFET ($R_{DS(ON)}$). For resistor sensing, a sense resistor is placed between the source of low side MOSFET and PGND (Figure 3(a)). $R_{DS(ON)}$ sensing is more efficient and less expensive (Figure 3(b)). However, there is a compromise between current limit accuracy and sense resistor power dissipation.

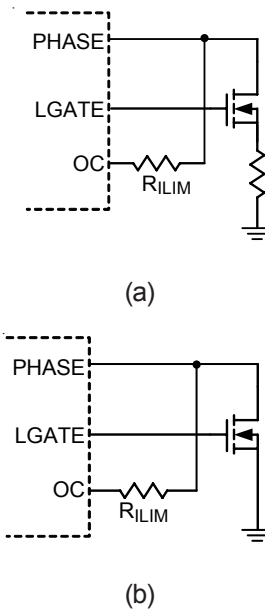

Figure 3. Current Sense Methods

In both cases, the R_{ILIM} resistor between the OC pin and PHASE pin sets the over current threshold. This resistor R_{ILIM} is connected to a 20µA current source within the RT8202L/M which is turned on when the low side MOSFET turns on. When the voltage drop across the sense resistor or low side MOSFET equals the voltage across the R_{ILIM}

resistor, positive current limit will activate. The high side MOSFET will not be turned on until the voltage drop across the sense element (resistor or MOSFET) falls below the voltage across the R_{ILIM} resistor.

Choose a current limit resistor by the following equation :

$$R_{ILIM} = \frac{I_{LIMIT} \times R_{SENSE}}{20\mu A}$$

Carefully observe the PC board layout guidelines to ensure that noise and DC errors do not corrupt the current sense signal seen by OC and PGND. Mount the IC close to the low-side MOSFET and sense resistor with short, direct traces, making a Kelvin sense connection to the sense resistor.

MOSFET Gate Driver (UGATE, LGATE)

The high side driver is designed to drive high current, low $R_{DS(ON)}$ N-MOSFET(s). When configured as a floating driver, 5V bias voltage is delivered from the VDDP supply. The average drive current is proportional to the gate charge at $V_{GS} = 5V$ times the switching frequency. The instantaneous drive current is supplied by the flying capacitor between the BOOT and PHASE pins.

A dead time to prevent shoot through is internally generated between high side MOSFET off to low side MOSFET on, and low side MOSFET off to high side MOSFET on.

The low side driver is designed to drive high current, low $R_{DS(ON)}$ N-MOSFET(s). The internal pull down transistor that drives LGATE low is robust, with a 0.7Ω typical on resistance. A 5V bias voltage is delivered from VDDP supply. The instantaneous drive current is supplied by the flying capacitor between VDDP and PGND.

For high current applications, some combinations of high and low side MOSFETs might be encountered that will cause excessive gate-drain coupling, which can lead to efficiency-killing, EMI producing shoot through currents. This is often remedied by adding a resistor in series with BOOT, which increases the turn-on time of the high side MOSFET without degrading the turn-off time (Figure 4).

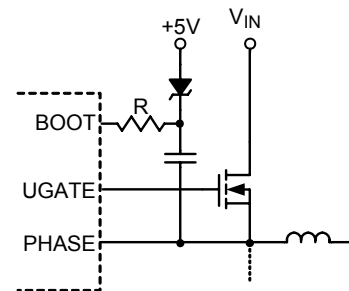

Figure 4. Reducing the UGATE Rise Time

Power Good Output (PGOOD)

The power good output is an open-drain output and requires a pull up resistor. When the output voltage is 15% above or 10% below its set voltage, PGOOD gets pulled low. It is held low until the output voltage returns to within these tolerances once more. In soft-start, PGOOD is actively held low and is allowed to transition high until soft-start is over and the output reaches 93% of its set voltage. There is a $2.5\mu s$ delay built into PGOOD circuitry to prevent false transition.

POR, UVLO and Soft-Start

Power on reset (POR) occurs when V_{DD} rises above to approximately 4.1V. The RT8202L/M will reset the fault latch and prepare the PWM for operation. At below 3.7V (min), the VDD undervoltage lockout (UVLO) circuitry inhibits switching by keeping UGATE and LGATE low.

A built in soft-start is used to prevent surge current from power supply input after EN/DEM is enabled. It clamps the ramping of internal reference voltage which is compared with the FB signal. The typical soft-start duration is 1.5ms.

Output Over Voltage Protection (OVP)

The output voltage can be continuously monitored for over voltage protection. When the output voltage exceeds 15% of its set voltage threshold, over voltage protection is triggered and the low side MOSFET is latched on. This activates the low side MOSFET to discharge the output capacitor.

The RT8202L/M is latched once OVP is triggered and can only be released by VDD or EN/DEM power on reset. There is a $20\mu s$ delay built into the over voltage protection circuit to prevent false transitions.

Output Under Voltage Protection (UVP)

The output voltage can be continuously monitored for under voltage protection. When the output voltage is less than 70% of its set voltage threshold, under voltage protection is triggered and then both UGATE and LGATE gate drivers are forced low. In order to remove the residual charge on the output capacitor during the under voltage period, if PHASE is greater than 1V, the LGATE is forced high until PHASE is lower than 1V. There is 2.5μs delay built into the under voltage protection circuit to prevent false transitions. During soft-start, the UVP will be blanked around 4.5ms.

Output Voltage Setting (FB)

The output voltage can be adjusted from 0.75V to 3.3V by setting the feedback resistors R6 and R7 (Figure 5). Choose R7 to be approximately 10kΩ, and solve for R6 using the equation :

$$V_{OUT} = V_{FB} \times \left(1 + \frac{R6}{R7} \right)$$

where V_{FB} is 0.75V.

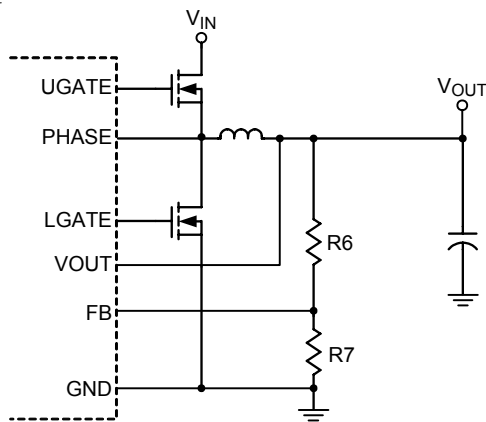

Figure 5. Setting The Output Voltage

Output Inductor Selection

The switching frequency (on-time) and operating point (% ripple or LIR) determine the inductor value as follows :

$$L = \frac{t_{ON} \times (V_{IN} - V_{OUT})}{LIR \times I_{LOAD(MAX)}}$$

Find a low pass inductor having the lowest possible DC resistance that fits in the allowed dimensions. Ferrite cores are often the best choice, although powdered iron is inexpensive and can work well at 200kHz. The core must

be large enough not to saturate at the peak inductor current (I_{PEAK}) :

$$I_{PEAK} = I_{LOAD(MAX)} + \left(\frac{LIR}{2} \times I_{LOAD(MAX)} \right)$$

Output Capacitor Selection

The output filter capacitor must have ESR low enough to meet output ripple and load transient requirement, yet have high enough ESR to satisfy stability requirements. Also, the capacitance value must be high enough to absorb the inductor energy going from a full load to no load condition without tripping the OVP circuit.

For CPU core voltage converters and other applications where the output is subject to violent load transient, the output capacitor's size depends on how much ESR is needed to prevent the output from dipping too low under a load transient. Ignoring the sag due to finite capacitance :

$$ESR \leq \frac{V_P - P}{I_{LOAD(MAX)}}$$

In non-CPU applications, the output capacitor's size depends on how much ESR is needed to maintain at an acceptable level of output voltage ripple :

$$ESR \leq \frac{V_P - P}{LIR \times I_{LOAD(MAX)}}$$

Organic semiconductor capacitor(s) or special polymer capacitor(s) are recommended.

Output Capacitor Stability

Stability is determined by the value of the ESR zero relative to the switching frequency. The point of instability is given by the following equation :

$$f = \frac{1}{2 \times \pi \times ESR \times C_{OUT}} < \frac{f_{SW}}{4}$$

Do not put high value ceramic capacitors directly across the outputs without taking precautions to ensure stability. Large ceramic capacitors can have a high ESR zero frequency and cause erratic and unstable operation. However, it is easy to add sufficient series resistance by placing the capacitors a couple of inches downstream from the inductor and connecting VOUT or the FB divider close to the inductor.

There are two related but distinct ways, double pulsing and feedback loop instability to identify the unstable operation.

Double pulsing occurs due to noise on the output or because the ESR is too low such that there is not enough voltage ramp in the output voltage signal. This “fools” the error comparator into triggering a new cycle immediately after the 400ns minimum off-time period has expired. Double pulsing is more annoying than harmful, resulting in nothing worse than increased output ripple. However, it may indicate the possible presence of loop instability, which is caused by insufficient ESR.

Loop instability can result in oscillation at the output after line or load perturbations and trip the over voltage protection latch or cause the output voltage to fall below the tolerance limit.

The easiest method for stability checking is to apply a zero-to-max load transient and carefully observe the output voltage ripple envelope for overshoot and ringing. It helps to simultaneously monitor the inductor current with an AC probe. Do not allow more than one ringing cycle after the initial step response under shoot or over shoot.

Thermal Considerations

For continuous operation, do not exceed absolute maximum junction temperature. The maximum power dissipation depends on the thermal resistance of the IC package, PCB layout, rate of surrounding airflow, and difference between junction and ambient temperature. The maximum power dissipation can be calculated by the following formula :

$$P_{D(MAX)} = (T_{J(MAX)} - T_A) / \theta_{JA}$$

where $T_{J(MAX)}$ is the maximum junction temperature, T_A is the ambient temperature, and θ_{JA} is the junction to ambient thermal resistance.

For recommended operating condition specifications of the RT8202L/M, the maximum junction temperature is 125°C and T_A is the ambient temperature. The junction to ambient thermal resistance, θ_{JA} , is layout dependent. For WQFN-16L 3x3 packages, the thermal resistance, θ_{JA} , is 68°C/W on a standard JEDEC 51-7 four-layer thermal test board. For WQFN-16L 4x4 packages, the thermal resistance, θ_{JA} , is 54°C/W on a standard JEDEC 51-7 four-layer thermal test board. The maximum power dissipation at $T_A = 25^\circ\text{C}$ can be calculated by the following formula :

$$P_{D(MAX)} = (125^\circ\text{C} - 25^\circ\text{C}) / (68^\circ\text{C/W}) = 1.471\text{W for WQFN-16L 3x3 package}$$

$$P_{D(MAX)} = (125^\circ\text{C} - 25^\circ\text{C}) / (54^\circ\text{C/W}) = 1.852\text{W for WQFN-16L 4x4 package}$$

The maximum power dissipation depends on the operating ambient temperature for fixed $T_{J(MAX)}$ and thermal resistance, θ_{JA} . For the RT8202L/M package, the derating curves in Figure 6 allow the designer to see the effect of rising ambient temperature on the maximum power dissipation.

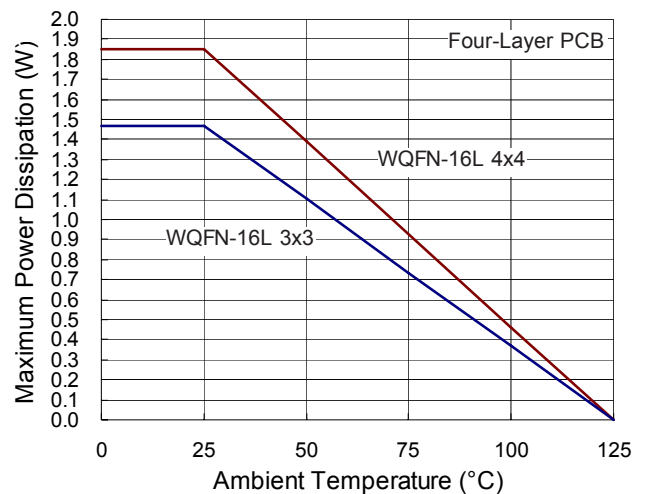

Figure 6. Derating Curve for the RT8202L/M Package

Layout Consideration

Layout is very important in high frequency switching converter design. If designed improperly, the PCB could radiate excessive noise and contribute to converter instability. Certain points must be considered before starting a layout for the RT8202L/M.

- ▶ Connect RC low-pass filter from VDDP to VDD, 1μF and 20Ω are recommended. Place the filter capacitor close to the IC.
- ▶ Keep current limit setting network as close as possible to the IC. Routing of the network should avoid coupling to high-voltage switching node.
- ▶ Connections from the drivers to the respective gate of the high side or low side MOSFET should be as short as possible to reduce stray inductance.

- ▶ All sensitive analog traces and components such as VOUT, FB, GND, EN/DEM, PGOOD, OC, VDD, and TON should be placed away from high voltage switching nodes such as PHASE, LGATE, UGATE, or BOOT nodes to avoid coupling. Use internal layer(s) as ground plane(s) and shield the feedback trace from power traces and components.
- ▶ Current sense connections must always be made using Kelvin connections to ensure an accurate signal, with the current limit resistor located at the device.
- ▶ Power sections should connect directly to ground plane(s) using multiple vias as required for current handling (including the chip power ground connections). Power components should be placed to minimize loops and reduce losses.

Outline Dimension

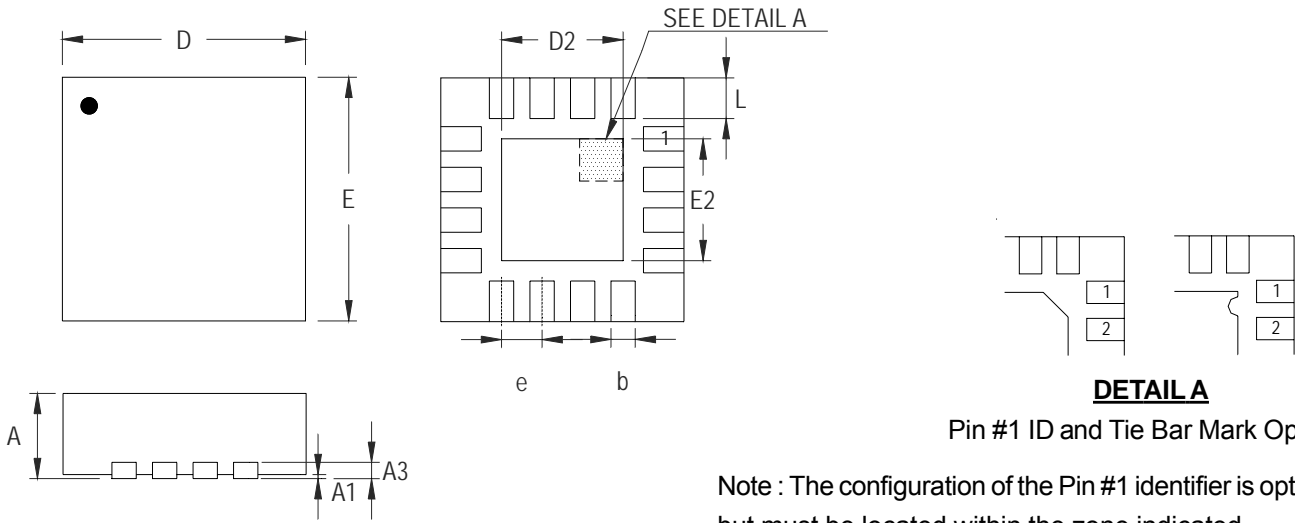

DETAIL A

Pin #1 ID and Tie Bar Mark Options

Note : The configuration of the Pin #1 identifier is optional, but must be located within the zone indicated.

Symbol	Dimensions In Millimeters		Dimensions In Inches	
	Min	Max	Min	Max
A	0.700	0.800	0.028	0.031
A1	0.000	0.050	0.000	0.002
A3	0.175	0.250	0.007	0.010
b	0.180	0.300	0.007	0.012
D	2.950	3.050	0.116	0.120
D2	1.300	1.750	0.051	0.069
E	2.950	3.050	0.116	0.120
E2	1.300	1.750	0.051	0.069
e	0.500		0.020	
L	0.350	0.450	0.014	0.018

W-Type 16L QFN 3x3 Package

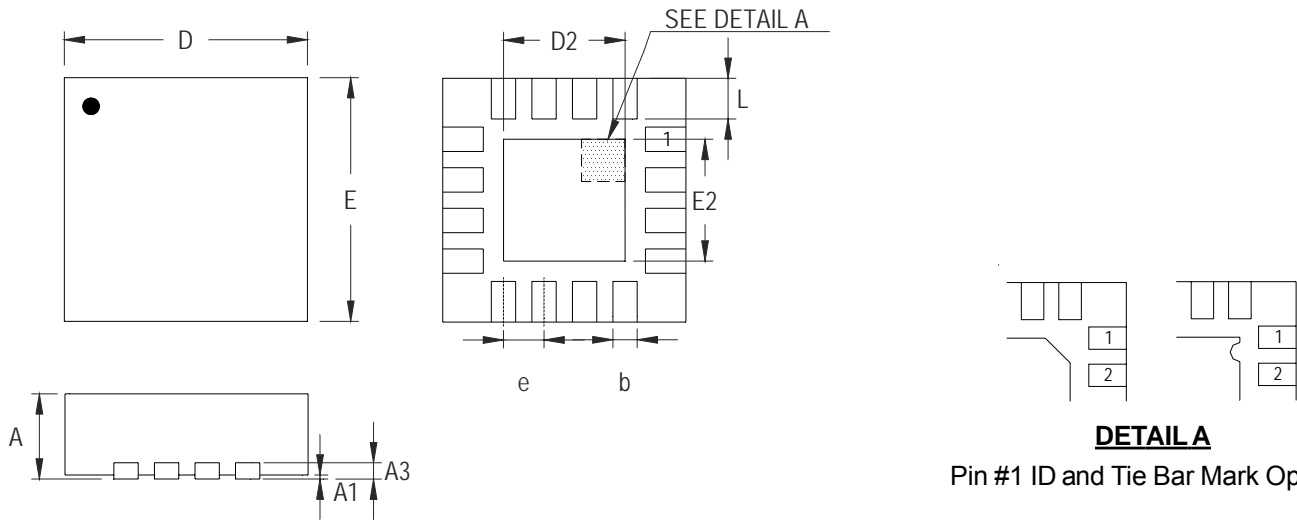

DETAIL A
Pin #1 ID and Tie Bar Mark Options

Note : The configuration of the Pin #1 identifier is optional, but must be located within the zone indicated.

Symbol	Dimensions In Millimeters		Dimensions In Inches	
	Min	Max	Min	Max
A	0.700	0.800	0.028	0.031
A1	0.000	0.050	0.000	0.002
A3	0.175	0.250	0.007	0.010
b	0.250	0.380	0.010	0.015
D	3.950	4.050	0.156	0.159
D2	2.000	2.450	0.079	0.096
E	3.950	4.050	0.156	0.159
E2	2.000	2.450	0.079	0.096
e	0.650		0.026	
L	0.500	0.600	0.020	0.024

W-Type 16L QFN 4x4 Package

Richtek Technology Corporation

Headquarter
5F, No. 20, Taiyuen Street, Chupei City
Hsinchu, Taiwan, R.O.C.
Tel: (8863)5526789 Fax: (8863)5526611

Richtek Technology Corporation

Taipei Office (Marketing)
5F, No. 95, Minchiuan Road, Hsintien City
Taipei County, Taiwan, R.O.C.
Tel: (8862)86672399 Fax: (8862)86672377
Email: marketing@richtek.com

Information that is provided by Richtek Technology Corporation is believed to be accurate and reliable. Richtek reserves the right to make any change in circuit design, specification or other related things if necessary without notice at any time. No third party intellectual property infringement of the applications should be guaranteed by users when integrating Richtek products into any application. No legal responsibility for any said applications is assumed by Richtek.