



YLI ELECTRONIC

CE ETS EMC tested MA
Patent: No.201420531846.3

Sturdiness Electric Bolt W/Narrow Door

Model:YB-500A/B(LED)

Parameters

Face Plate	192Lx25Wx37H(mm)
Strike	92Lx25Wx3H(mm)
Bolt	16(projecture)*13(diameter)(mm)
Holding Force	1000Kg
Time Delay	0/3/6/9sec(Adjustable)
Voltage	12VDC(standard); 24VDC(need order)
Current	Start 12V/960mA; Standby 12V/180mA Start 24V/700mA; Standby 24V/60mA
Signal Output	NO/COM
Feature	Fail Safe [YB-500A(LED)]; Fail Secure [YB-500B(LED)]
LED	Green indicates the door is unlock; Red indicates the door is lock
Material	304 stainless steel, wire draw finishing
Induction Distance	8mm
Suitable for	Wooden door, glass door, metal door ,Fireproof door
Weight	0.68kg

Dimensions

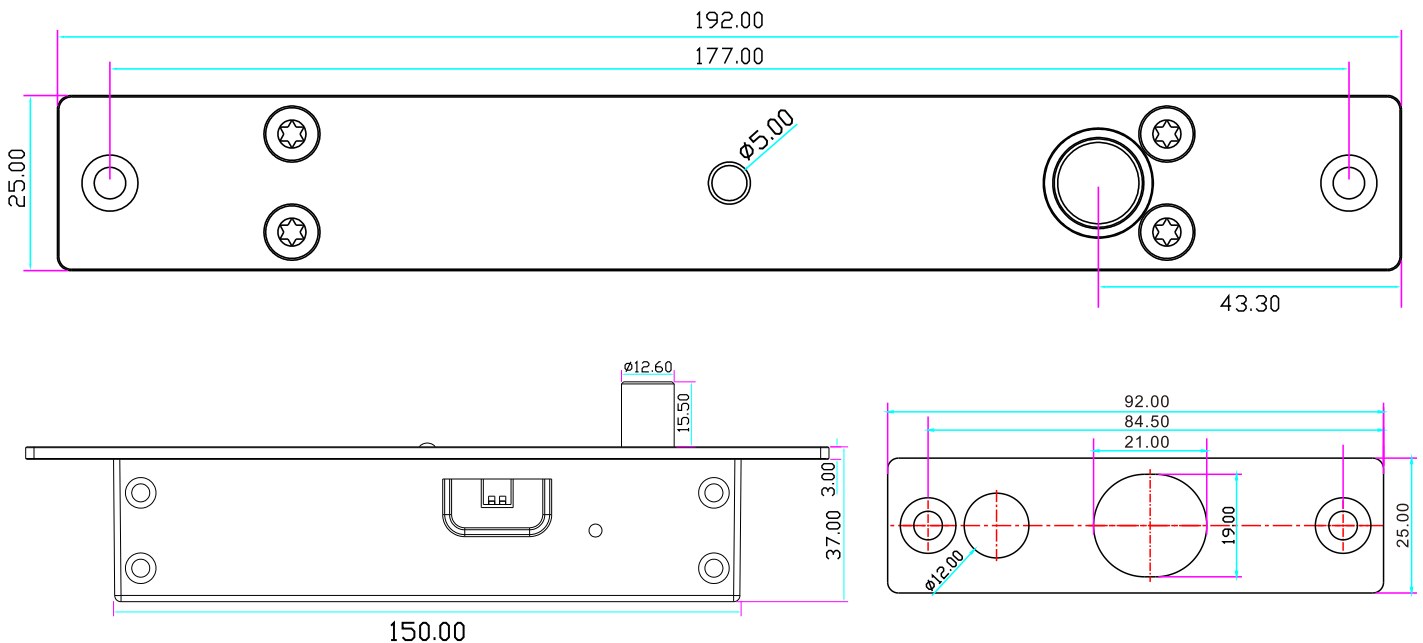

Installation

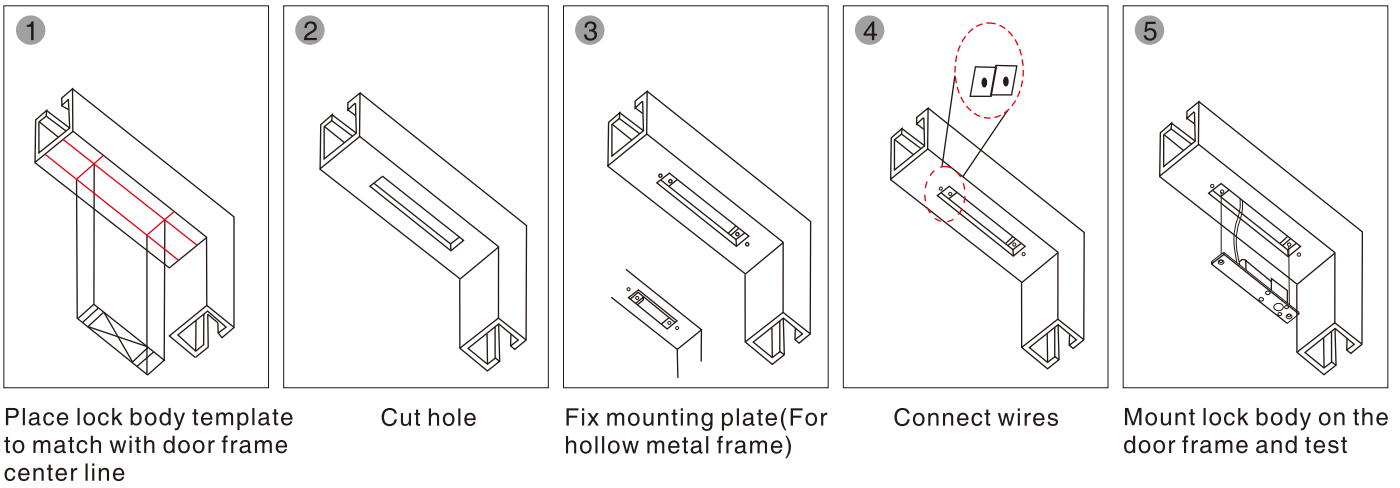

Installation Schematic

Suitable for 10-15mm glass door, BK-600/601/602 for Frameless Glass Door.

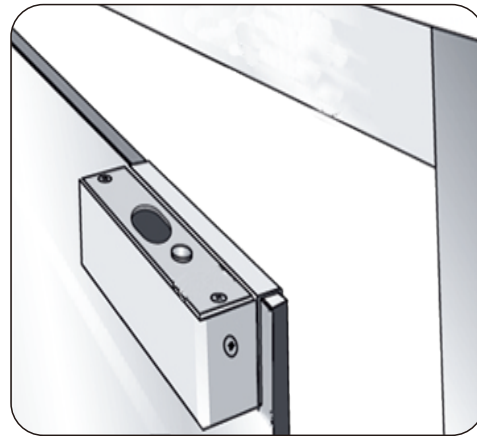
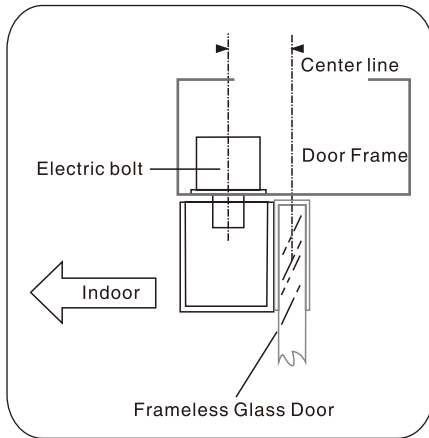

Wiring Diagram

