

VERDERFLEX[®]



Peristaltic Industrial Hose Pump

Spare Parts List

VF 100-125

Version 4.4v-01/2020

Print-No. 01

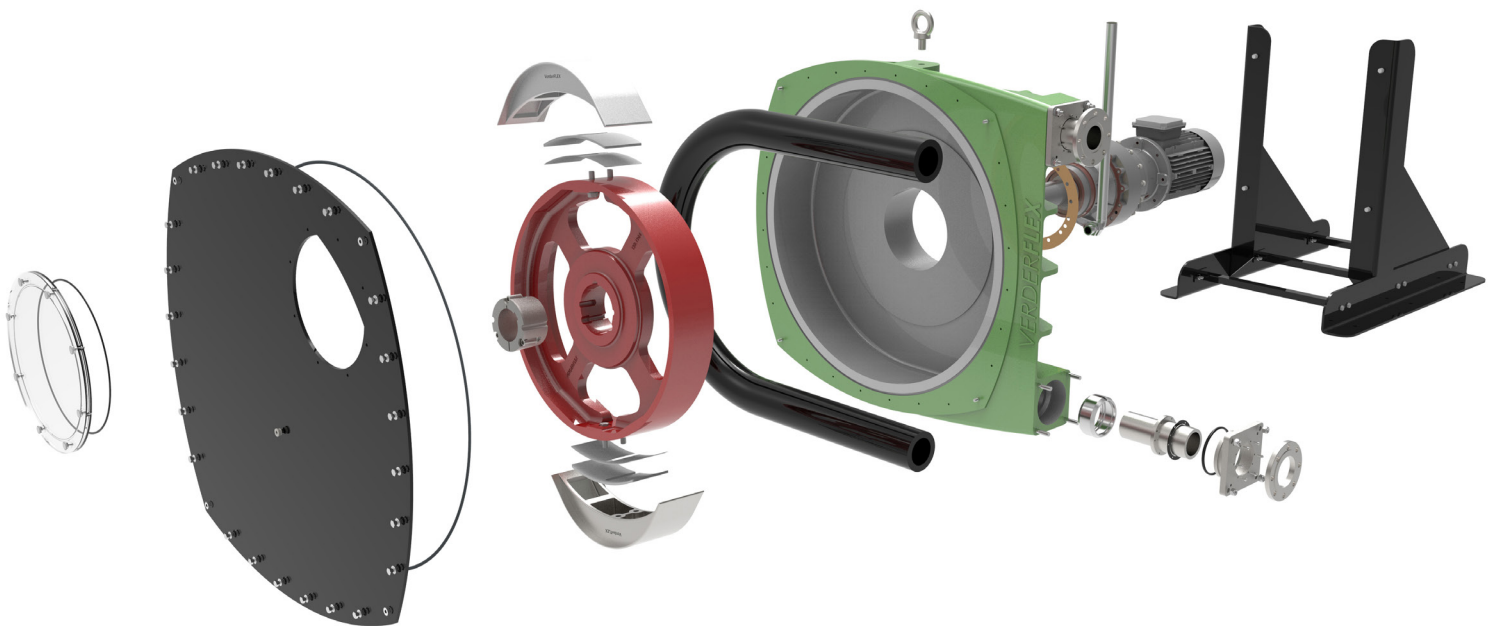

VERDER
passion for pumps

Version 4.4v-01/2020
Print-No. 01

VF 100-125

VF 100-125 Spare Parts List

Table 1 contains a list of spares to help maintain and repair the VF 100-125 peristaltic pumps. If in doubt, please contact your local Verder distributor with the pump serial number for genuine Verderflex® spares.

Pump Layout – Exploded view VF 100-125

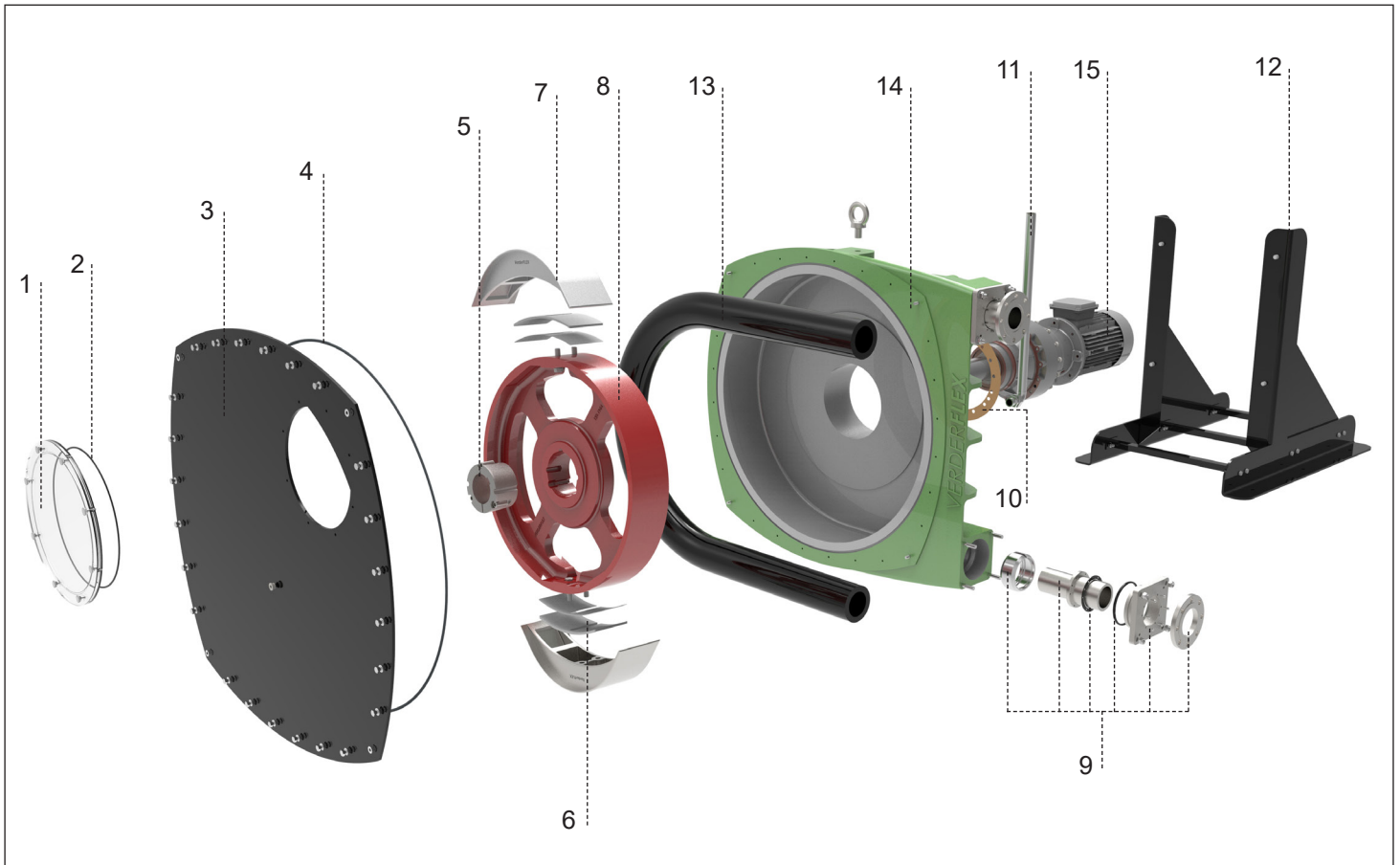

Figure 1 Layout VF 100 (Generic View)

1	Inspection Window	6	Shims	11	Filler Tube
2	Inspection Window O-Ring	7	Rotor Shoe	12	Frames
3	Front Cover	8	Rotor	13	Hose
4	Front Cover O-Ring	9	Port Flange	14	Pump Housing
5	Rotor Mounting Bush	10	Drive Gasket	15	Motor

Table 1 VF 100-125 Spare Parts List











Ref	Item	Part No		Qty	Image	
1.	Inspection Window with O-ring	VF 100	129.1235	1		
		VF 125	129.1236			
2.	Inspection Window O-ring	VF 100	129.1944 (388 x 5.3mm)	1		
		VF 125	129.1979 (487 x 5.3mm)			
3.	Front Cover	VF 100	129.1927	1		
		VF 125	129.1969			
3.1	Level Plug	VF 100 VF 125	129.1114			
4.	Front Cover O-Ring	VF 100	129.1950 (L3958 x 8.4mm)	1		
		VF 125	129.1112 (L1580 x 8.4mm)			
5.	Rotor Mounting Bush	VF 100 VF 125	5040 x 110	129.1960	1	
			5040 x 120	129.1963		
6.	Shims	VF 100	Pack of 14	129.1393.M	1	
		VF 125	Pack of 14	129.1394.M		

Table 1 VF 100-125 Spare Parts List (continued)

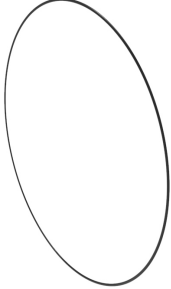
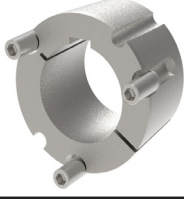
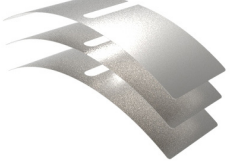
Ref	Item	Part No		Qty	Image	
7.	Rotor Shoes 2 in a set <i>(does not include pack of shims)</i>	VF 100	129.1362	1		
		VF 125	129.1363			
7.1	Rotor Shoes Assembly <i>(pair of shoes and pack of shims)</i>	VF 100	129.1362.A	1		
		VF 125	129.1363.A			
8.	Rotor	VF 100	129.1964	1		
		VF 125	129.1982			
9.	Port Flange Assembly <i>(supplied in pairs)</i>	VF 100	129.0894	1		
		VF 125	129.0895			
9.1	Port Flange Insert <i>(supplied in pairs)</i>	VF 100	SS	129.1976	1	
			PP*	129.1976.P		
			PVDF*	129.1976.V		
		VF 125	SS	129.1970.S		
			PP*	129.1970.P		
			PVDF*	129.1970.V		
9.2	Port Flange Outer O-Rings <i>(supplied in pairs)</i>	VF 100	129.1958	1		
		VF 125	129.1957			

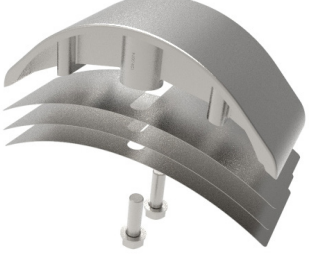
* For temperature limits, please check the datasheet.

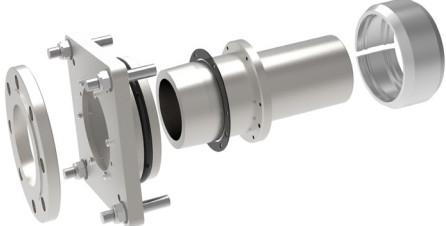
Table 1 VF 100-125 Spare Parts List (continued)





Ref	Item	Part No		Qty	Image
9.3	Port Flange Outer <i>(supplied in pairs)</i>	VF 100	129.1943	1	
		VF 125	129.1971		
9.4	Flange Sealing Kit <i>(supplied in pairs)</i>	VF 100	129.1039	1	
		VF 125	129.1040		
9.5	Screw on Flange <i>(supplied in pairs)</i>	V 100	129.1952	1	
			129.1952A		
		VF 125	129.1951		
			129.1953		
			129.1951A		
			129.1953A		
10.	Drive Gasket	VF 100 VF 125	129.1937 (33 Holes)	1	
			129.2978 (18 Holes)		
11.	Filler Tube	VF 100	129.1261	1	
		VF 125			
12.	Mounting Frame Assembly	VF 100	129.1322	1	
		VF 125	129.1323		

Table 2 VF 100-125 Accessories

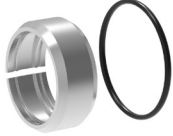

Item		Part No		Qty	Image
Revolution Sensor		VF 100 VF 125	129.0805	1	
Hose Burst and Vent Kit (Non-Atex)		VF 100 VF 125	129.0721	1	
High /Low Level Level Switch Assembly		VF 100 VF 125	129.3000	1	
Hose Burst Relay	Industrial Relay 24V DC	VF 100 VF 125	129.0694	1	
	Industrial Relay 110V AC		129.0695		
	Industrial Relay 230V AC 50hz		129.0696		

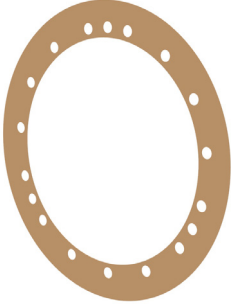
Table 3 VF 100-125 Parts for reference (not supplied as individual spares by Verderflex)

Item	Part No		Qty
Mounting Frame Fastener Kit	VF 100	129.0908.1P	1 set
	VF 125	129.0909.1P	
Rotor Shoe Assembly Fastener Kit	VF 100	129.0908.2P	1 set
	VF 125	129.0909.2P	
Port Flange Assembly Fastener Kit	VF 100	129.0908.3P	1 set
	VF 125	129.0909.3P	
Casing Assembly Fastener Kit	VF 100	129.0908.4P	1 set
	VF 125	129.0909.4P	
Mounting Frame Assembly Fastener Kit	VF 100	129.0908.5P	1 set
	VF 125	129.0909.5P	

Table 4 VF 100-125 Hose Options

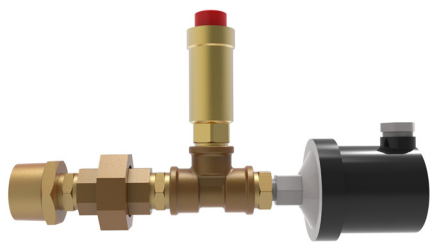
Item		Part No		Qty	Image
Hose option <i>NR/White</i>	singles	VF 100	129.0009	1	
		VF 125	129.9016		
Hose option <i>NBR/Yellow</i>	singles	VF 100	129.0520	1	
		VF 125	129.9021		
Hose option <i>NBRF/Yellow + White</i>	singles	VF 100	129.2029	1	
		VF 125	<i>Not Applicable</i>		
Hose option <i>Hypalon® / Green</i>	singles	VF 100	129.2018	1	
		VF 125	129.2019		
Hose option <i>EPDM/Red</i>	singles	VF 100	129.0018	1	
		VF 125	129.9020		

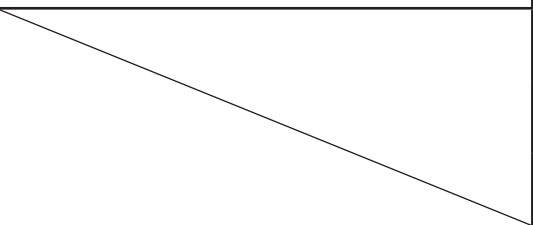
Table 5 VF 100-125 Pump Lubricants

The pump must always be filled with the correct amount of lubricant to the middle level mark of the front cover. Table 5 shows the standard amount of lubricant supplied with VF pumps in litres and US gallons.

Pump Size	Lubricant	Standard Quantity Supplied with Pump in Litre (US Gallons)	Part No	Qty Bottle
VF 100	Verderlube®	60 (15.8)	129.1417	4 x 15 L
		60 (15.8)	129.1422	3 x 20 L
	VerderSil®	60 (15.8)	129.1378	4 x 15 L
		60 (15.8)	129.1382	3 x 20 L
VF 125	Verderlube®	80 (21.1)	129.1417 129.1420	5 x 15 L 1 x 5 L
		80 (21.1)	129.1422	4 x 20 L
	VerderSil®	80 (21.1)	129.1378 129.1375	5 x 15 L 1 x 5 L
		80 (21.1)	129.1382	4 x 20 L