

**VERDERFLEX<sup>®</sup>**



# Peristaltic Industrial Hose Pump

Spare Parts List

VF 65-80

Version 8.3v-03/2020

Print-No. 01

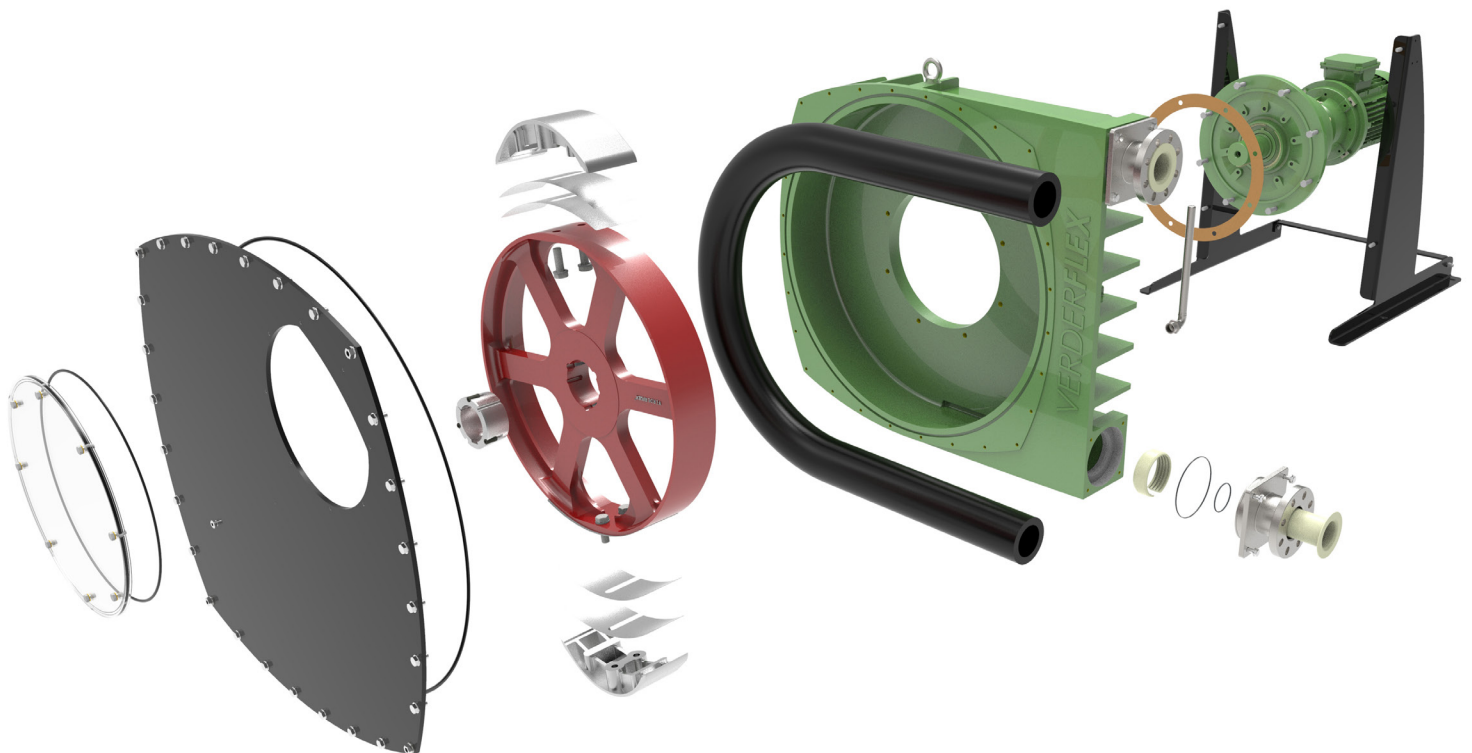

**VERDER**  
passion for pumps

Version 8.3v-03/2020  
Print-No. 01

**VF 65-80**

## VF 65-80 Spare Parts List

Table 1 contains a list of spares to help maintain and repair the VF 65-80 peristaltic pumps. If in doubt, please contact your local Verder distributor with the pump serial number for genuine Verderflex® spares.

### Pump Layout – Exploded view VF 65-80

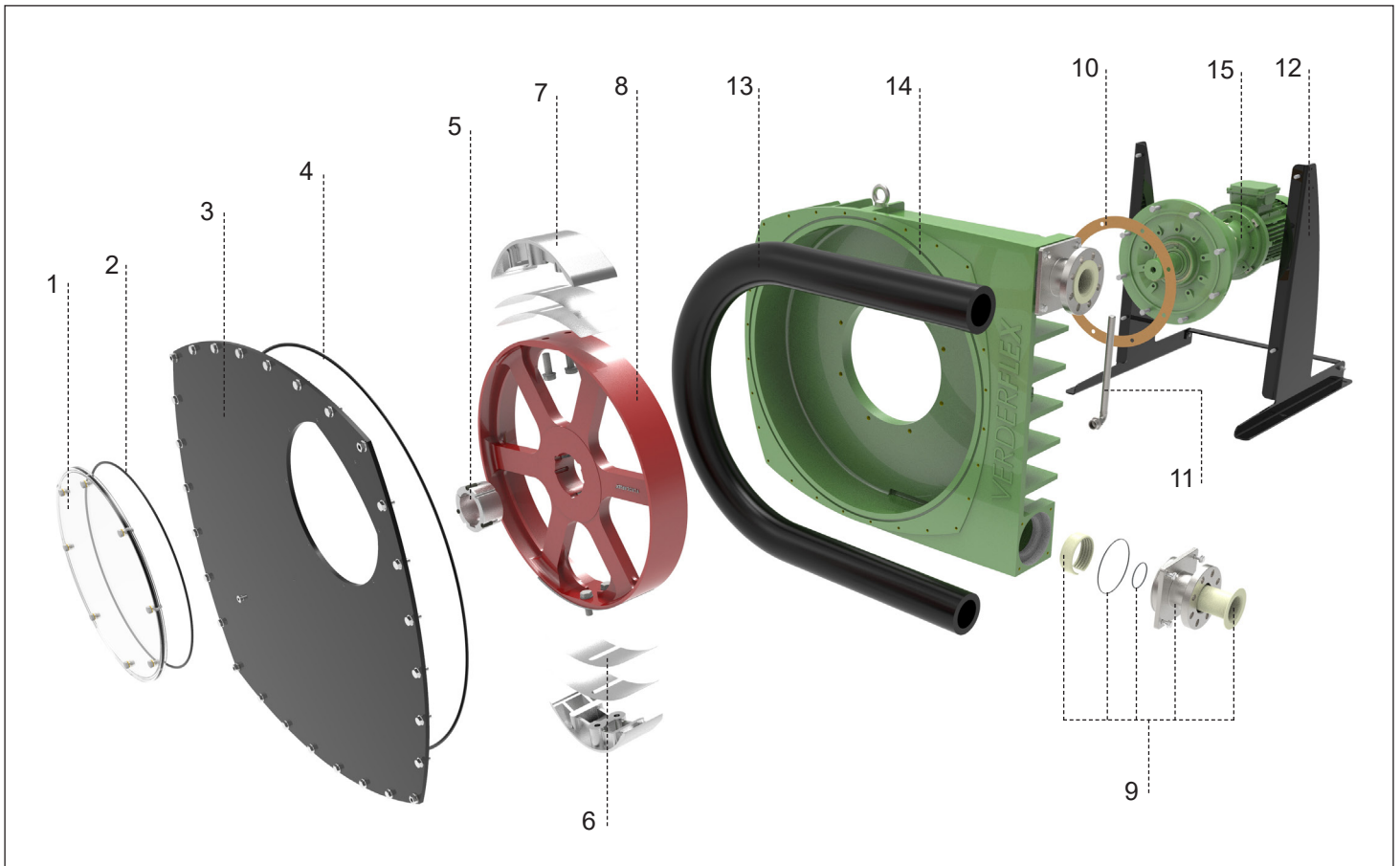

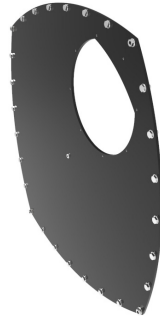

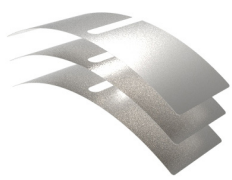



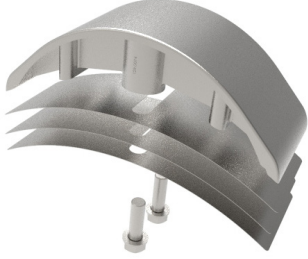

Figure 1 Layout VF 65-80 (Generic View)

1	Inspection Window	6	Shims	11	Filler Tube
2	Inspection Window O-Ring	7	Rotor Shoe	12	Frames
3	Front Cover	8	Rotor	13	Hose
4	Front Cover O-Ring	9	Port Flange	14	Pump Housing
5	Rotor Mounting Bush	10	Drive Gasket	15	Motor

**Table 1 VF 65-80 Spare Parts List**

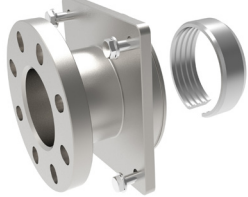
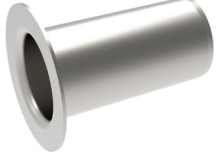
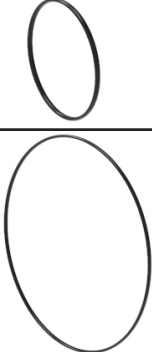

Ref	Item	Part No		Qty	Image	
1.	Inspection Window with O-ring	VF 65	129.1227	1		
		VF 80	129.1228			
2.	Inspection Window O-ring (pack of 5)	VF 65	129.1243	1		
		VF 80	129.1244			
3.	Front Cover	VF 65	129.1145	1		
		VF 80	129.1146			
4.	Front Cover O-Ring	VF 65	129.0081	1		
		VF 80	129.0082			
5.	Rotor Mounting Bush	VF 65	3525 x 60	129.0067.60	1	
			3525 x 70	129.0067		
		VF 80	3525 x 80	129.0067.80		
			3525 X 90	129.0068		
			3525 x 100	129.0068.100		
6.	Shims	VF 65	Pack of 12	129.1391.M	1	
		VF 80	Pack of 16	129.1392.M		

**Table 1 VF 65-80 Spare Parts List (continued)**

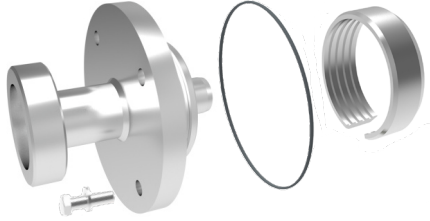
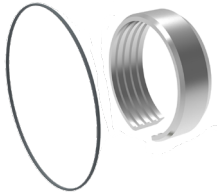
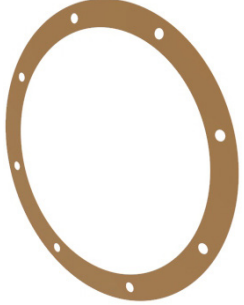

Ref	Item		Part No		Qty	Image
7.	Rotor Shoes  2 in a set <i>(does not include pack of shims)</i>		VF 65	129.1360	1	
			VF 80	129.1361		
7.1	Rotor Shoes Assembly <i>(pair of shoes and pack of 12 shims)</i>		VF 65	129.1360.A	1	
			VF 80	129.1361.A		
8.	Rotor		VF 65	129.1374	1	
			VF 80	129.0602		
9.	Port Flange Assembly 304 Stainless Steel  <i>(supplied in pairs)</i>		VF 65	129.0890.U	1	
			VF 80	129.0891.U		
9.1	Port Flange Insert <i>(supplied in pairs)</i>	SS	VF 65	129.1414.S	1	
		PP*		129.1414.P		
		PVDF*		129.1414.V		
		SS	VF 80	129.1415.S		
		PP*		129.1415.P		
		PVDF*		129.1415.V		
9.2	Port Flange O-Rings	Inner O-ring	VF 65	129.1404	1	
			VF 80	129.1405		
		Outer O-ring	VF 65	129.1436		
			VF 80	129.1437		

\* For temperature limits, please check the datasheet.

**Table 1 VF 65-80 Spare Parts List (continued)**

Ref	Item	Part No		Qty	Image
9.3	Tri-Clamp Port Flange Assembly DIN 32676 <i>(supplied in pairs)</i>	VF 65	129.1306.SS	1	
		VF 80	129.1310.SS		
9.4	Flange Sealing Kit <i>(supplied in pairs)</i>	VF 65	129.1037	1	
		VF 80	129.2038		
10.	Drive Gasket	VF 65	129.0485	1	
		VF 80	129.0486		
11.	Filler Tube	VF 65	129.0762	1	
		VF 80	129.0762		
12.	Mounting Frame Assembly	VF 65	129.1320.MC	1	
		VF 80	129.1321.MC		

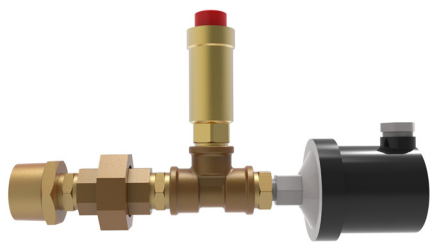
**Table 2 VF 65-80 Accessories**

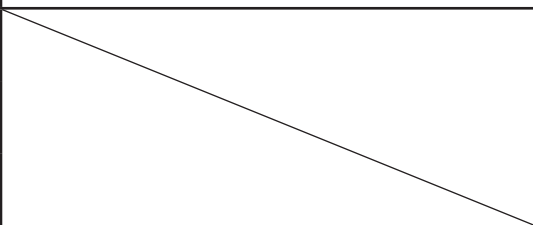
Item		Part No		Qty	Image
Revolution Sensor		VF 65 VF 80	129.0805	1	
Hose Burst and Vent Kit (Non-Atex)		VF 65 VF 80	129.0720	1	
High /Low Level Level Switch Assembly		VF 65 VF 80	129.3000	1	
Hose Burst Relay	Industrial Relay 24V DC	VF 65 VF 80	129.0694	1	
	Industrial Relay 110V AC		129.0695		
	Industrial Relay 230V AC 50hz		129.0696		

**Table 3 VF 65-80 Parts for reference (not supplied as individual spares by Verderflex )**

Item	Part No		Qty	Contents	
Mounting Frame Fastener Kit	VF 65	129.0906.1P	4	M16 washer	Mounting frame to pump case
			4	M16X40 bolt	Mounting frame to pump case
	VF 80	129.0907.1P	2	M12X40 bolt	Cross member to support frame
			2	M12 Nylon insert nut	Cross member to support frame
			4	M12 washer	Cross member to support frame
Rotor Shoe Assembly Fastener Kit	VF 65	129.0906.2P	2	M20 washer	Rotor shoe fastening
			2	M20X60 bolt	Rotor shoe fastening
			2	M12X27 split dowel pin	Rotor shoe fastening
	VF 80	129.0907.2P	4	M20 washer	Rotor shoe fastening
			4	M20X60 bolt	Rotor shoe fastening
Port Flange Assembly Fastener Kit	VF 65	129.0906.3P	2	M12 washer	Port flange to pump case
			VF 80	129.0907.3P	2
Casing Assembly Fastener Kit	VF 65	129.0906.4P			8
			16	M16 Washer	Drive to gearbox connection
			8	M16 Nylon insert nut	Drive to gearbox connection
			24	M12X25 bolt	Front cover to pump case
			28	M12 washer	Front cover to pump case
			2	1" BSP plug	Drain plug
			2	M33 Nylon washer	Drain plug
			4	M12X35 stud	Front cover to pump case
			8	M8X20 bolt	Inspection cover to front cover
			1	M20 Eye bolt	Lifting point on casing
			8	M8X3 Nylon washer	Inspection cover to front cover
Mounting Frame Assembly Fastener Kit	VF 80	129.0907.5P	4	M16 washer	Mounting frame to pump case
			4	M16X40 bolt	Mounting frame to pump case
			6	M12X40 bolt	Long coupled only - base plate
			6	M12 Nylon insert nut	Long coupled only - base plate
			12	M12 washer	Long coupled only - base plate
			4	M8X24 Dowel pin	Long coupled only - base plate

**Table 4 VF 65-80 Hose Options**

Item		Part No		Qty	Image
Hose option <i>NR/White</i>	singles	VF 65	139.0007	1	
		VF 80	139.0008		
Hose option <i>NBR/Yellow</i>	singles	VF 65	139.0518	1	
		VF 80	139.0519		
Hose option <i>NBRF/Yellow + White</i>	singles	VF 65	139.2027	1	
		VF 80	139.2028		
Hose option <i>Hypalon® / Green</i>	singles	VF 65	139.2016	1	
		VF 80	139.2017		
Hose option <i>EPDM/Red</i>	singles	VF 65	139.0016	1	
		VF 80	139.0017		

## Table 5 VF 65-80 Pump Lubricants

The pump must always be filled with the correct amount of lubricant to the middle level mark of the front cover. Table 5 shows the standard amount of lubricant supplied with VF pumps in litres and US gallons.

Pump Size	Lubricant	Standard Quantity Supplied with Pump in Litre (US Gallons)	Part No	Qty Bottle
VF 65	Verderlube®	25(6.6)	129.1421 129.1417	1 x 10 L 1 x 15 L
	VerderSil®		129.1376 129.1378	1 x 10 L 1 x 15 L
VF 80	Verderlube®	35 (9.3)	129.1420 129.1417	1 x 5 L 2 x 15 L
	VerderSil®		129.1375 129.1378	1 x 5 L 2 x 15 L