

Triacs

BT137S series
BT137M series

GENERAL DESCRIPTION

Glass passivated triacs in a plastic envelope, suitable for surface mounting, intended for use in applications requiring high bidirectional transient and blocking voltage capability and high thermal cycling performance. Typical applications include motor control, industrial and domestic lighting, heating and static switching.

QUICK REFERENCE DATA

SYMBOL	PARAMETER	MAX.	MAX.	MAX.	UNIT
V_{DRM}	BT137S (or BT137M)-	500	600	800	V
	BT137S (or BT137M)-	500F	600F	800F	
	BT137S (or BT137M)-	500G	600G	800G	
	Repetitive peak off-state voltages	500	600	800	
$I_{T(RMS)}$	RMS on-state current	8	8	8	A
I_{TSM}	Non-repetitive peak on-state current	65	65	65	A

PINNING - SOT428

PIN NUMBER	Standard S	Alternative M
1	MT1	gate
2	MT2	MT2
3	gate	MT1
tab	MT2	MT2

PIN CONFIGURATION

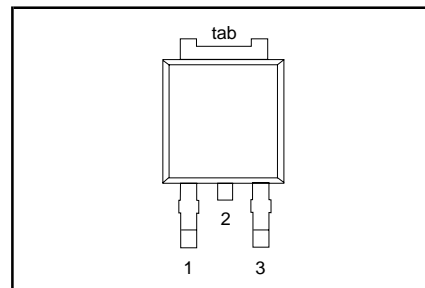

SYMBOL

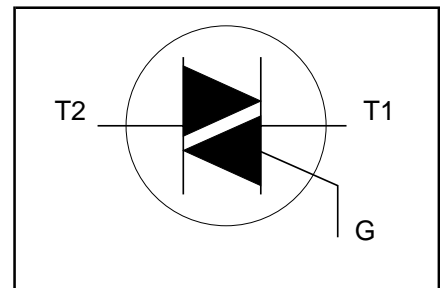

LIMITING VALUES

Limiting values in accordance with the Absolute Maximum System (IEC 134).

SYMBOL	PARAMETER	CONDITIONS	MIN.	MAX.			UNIT
				-500	-600	-800	
V_{DRM}	Repetitive peak off-state voltages		-	500 ¹	600 ¹	800	V
$I_{T(RMS)}$	RMS on-state current	full sine wave; $T_{mb} \leq 102\text{ }^\circ\text{C}$	-	8			A
I_{TSM}	Non-repetitive peak on-state current	full sine wave; $T_j = 25\text{ }^\circ\text{C}$ prior to surge $t = 20\text{ ms}$	-	65			A
		$t = 16.7\text{ ms}$	-	71			A
I^2t	I^2t for fusing	$t = 10\text{ ms}$	-	21			A ² s
dl_T/dt	Repetitive rate of rise of on-state current after triggering	$I_{TM} = 12\text{ A}$; $I_G = 0.2\text{ A}$; $dl_G/dt = 0.2\text{ A}/\mu\text{s}$					
		T2+ G+	-	50			A/ μs
		T2+ G-	-	50			A/ μs
		T2- G-	-	50			A/ μs
		T2- G+	-	10			A/ μs
I_{GM}	Peak gate current		-	2			A
V_{GM}	Peak gate voltage		-	5			V
P_{GM}	Peak gate power		-	5			W
$P_{G(AV)}$	Average gate power		-	0.5			W
T_{stg}	Storage temperature		-40	150			$^\circ\text{C}$
T_j	Operating junction temperature		-	125			$^\circ\text{C}$

¹ Although not recommended, off-state voltages up to 800V may be applied without damage, but the triac may switch to the on-state. The rate of rise of current should not exceed 6 A/ μs .

Triacs

BT137S series
BT137M series

THERMAL RESISTANCES

SYMBOL	PARAMETER	CONDITIONS	MIN.	TYP.	MAX.	UNIT
$R_{th\ j-mb}$	Thermal resistance junction to mounting base	full cycle	-	-	2.0	K/W
		half cycle	-	-	2.4	K/W
$R_{th\ j-a}$	Thermal resistance junction to ambient	pcb (FR4) mounted; footprint as in Fig.14	-	75	-	K/W

STATIC CHARACTERISTICS

 $T_j = 25\text{ }^\circ\text{C}$ unless otherwise stated

SYMBOL	PARAMETER	CONDITIONS	MIN.	TYP.	MAX.			UNIT
I_{GT}	Gate trigger current	BT137S -(or BT137M) $V_D = 12\text{ V}; I_T = 0.1\text{ A}$	-	-F	...G	
		T2+ G+	-	5	35	25	50	mA
		T2+ G-	-	8	35	25	50	mA
		T2- G-	-	11	35	25	50	mA
I_L	Latching current	T2- G+	-	30	70	70	100	mA
		$V_D = 12\text{ V}; I_{GT} = 0.1\text{ A}$	-	-	-	-	-	
		T2+ G+	-	7	30	30	45	mA
		T2+ G-	-	16	45	45	60	mA
I_H	Holding current	T2- G-	-	5	30	30	45	mA
		T2- G+	-	7	45	45	60	mA
		$V_D = 12\text{ V}; I_{GT} = 0.1\text{ A}$	-	5	20	20	40	mA
		$I_T = 10\text{ A}$	-	1.3	1.65			V
V_T	On-state voltage	$V_D = 12\text{ V}; I_T = 0.1\text{ A}$	-	0.7	1.5			V
V_{GT}	Gate trigger voltage	$V_D = 400\text{ V}; I_T = 0.1\text{ A};$ $T_j = 125\text{ }^\circ\text{C}$	0.25	0.4	-			V
I_D	Off-state leakage current	$V_D = V_{DRM(max)};$ $T_j = 125\text{ }^\circ\text{C}$	-	0.1	0.5			mA

DYNAMIC CHARACTERISTICS

 $T_j = 25\text{ }^\circ\text{C}$ unless otherwise stated

SYMBOL	PARAMETER	CONDITIONS	MIN.			TYP.	MAX.	UNIT
dV_D/dt	Critical rate of rise of off-state voltage	BT137S -(or BT137M) $V_{DM} = 67\% V_{DRM(max)};$ $T_j = 125\text{ }^\circ\text{C};$ exponential waveform; gate open circuitF	...G	250	-	V/ μs
dV_{com}/dt	Critical rate of change of commutating voltage	$V_{DM} = 400\text{ V}; T_j = 95\text{ }^\circ\text{C};$ $I_{T(RMS)} = 8\text{ A};$ $dl_{com}/dt = 3.6\text{ A/ms};$ gate open circuit	-	-	10	20	-	V/ μs
t_{gt}	Gate controlled turn-on time	$I_{TM} = 12\text{ A}; V_D = V_{DRM(max)};$ $I_G = 0.1\text{ A}; dl_G/dt = 5\text{ A}/\mu\text{s}$	-	-	-	2	-	μs

Triacs

BT137S series
BT137M series

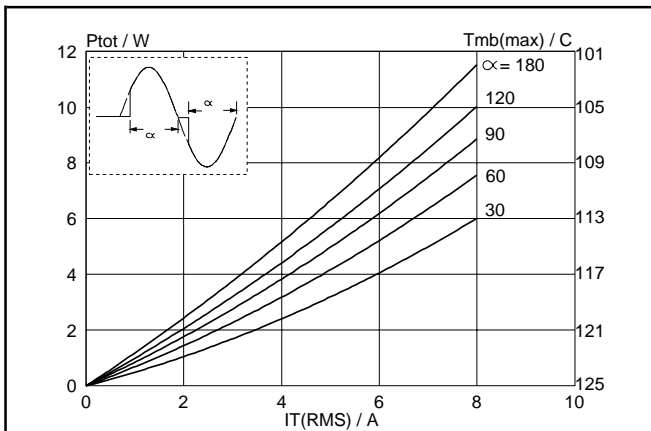

Fig.1. Maximum on-state dissipation, P_{tot} , versus rms on-state current, $I_{T(RMS)}$, where $\alpha =$ conduction angle.

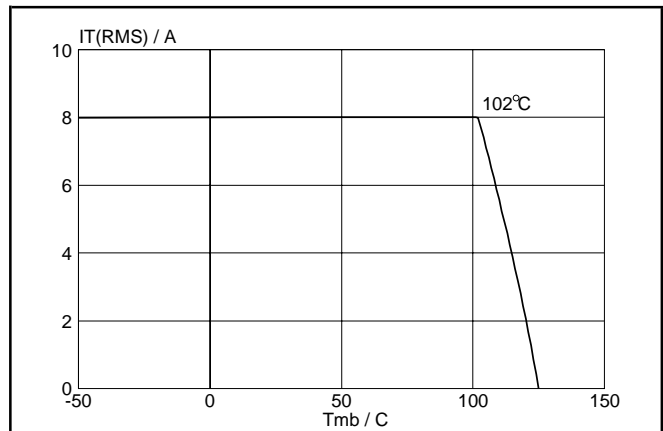

Fig.4. Maximum permissible rms current $I_{T(RMS)}$, versus mounting base temperature T_{mb} .

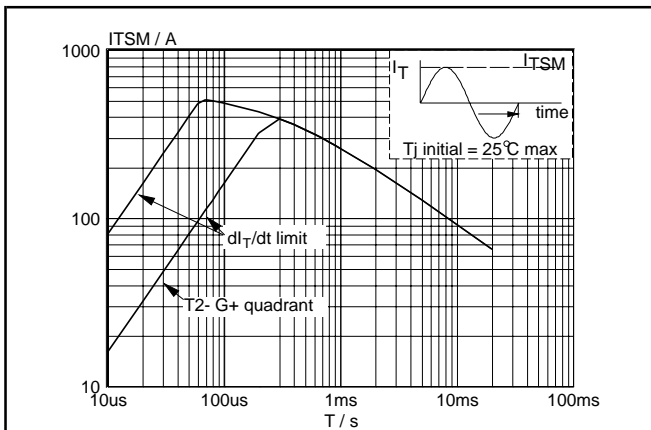

Fig.2. Maximum permissible non-repetitive peak on-state current I_{TSM} , versus pulse width t_p , for sinusoidal currents, $t_p \leq 20$ ms.

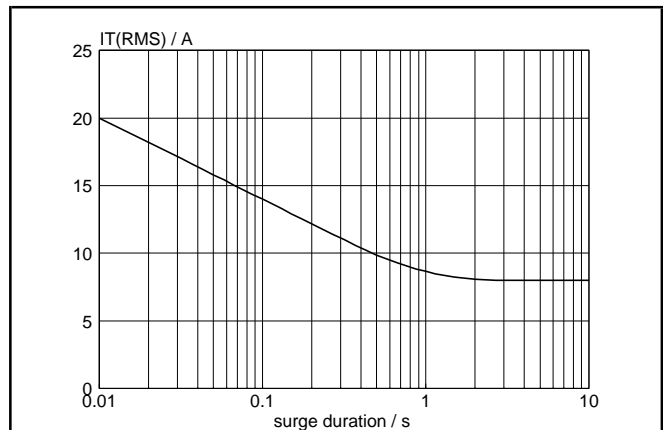

Fig.5. Maximum permissible repetitive rms on-state current $I_{T(RMS)}$, versus surge duration, for sinusoidal currents, $f = 50$ Hz; $T_{mb} \leq 102^\circ$ C.

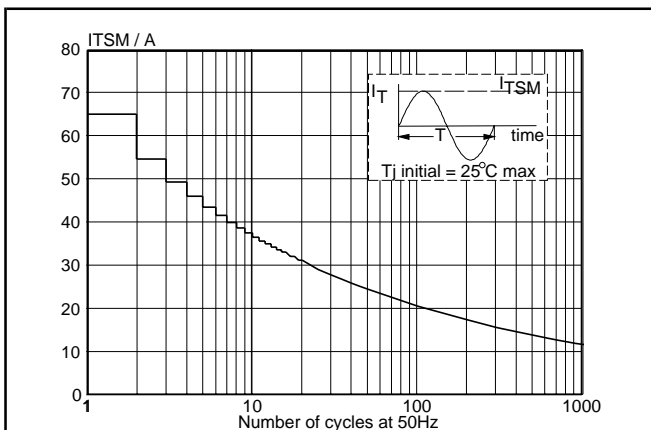

Fig.3. Maximum permissible non-repetitive peak on-state current I_{TSM} , versus number of cycles, for sinusoidal currents, $f = 50$ Hz.

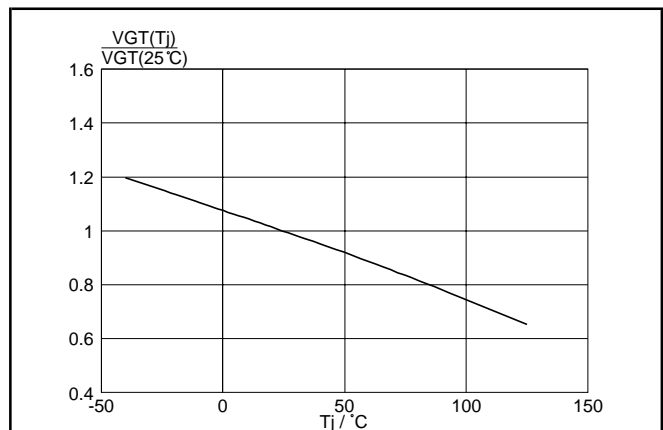
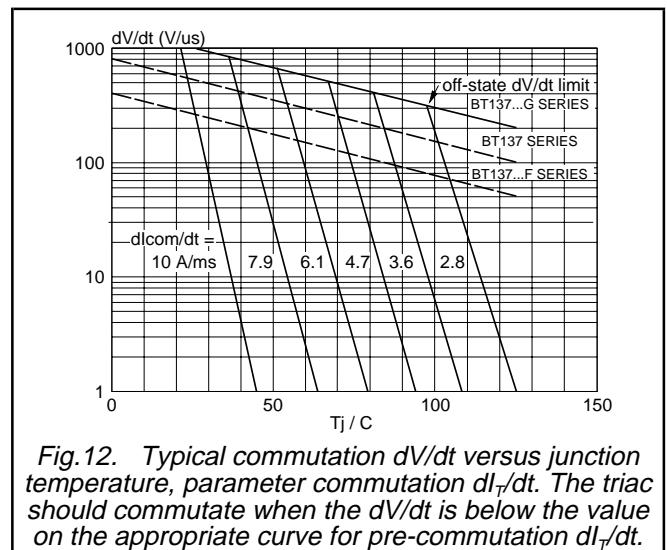
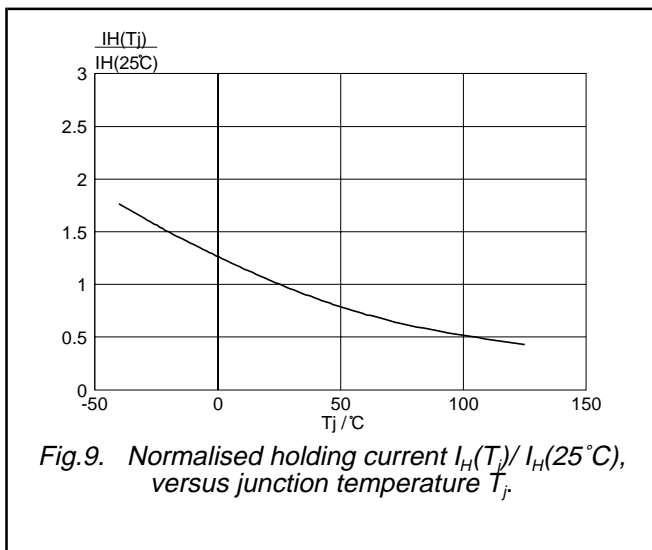
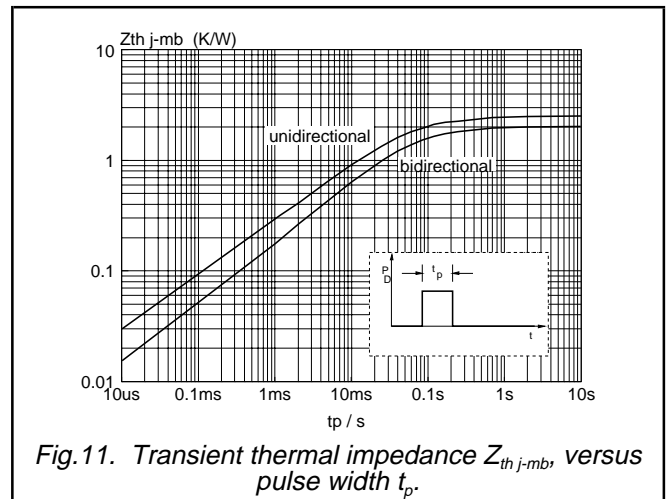
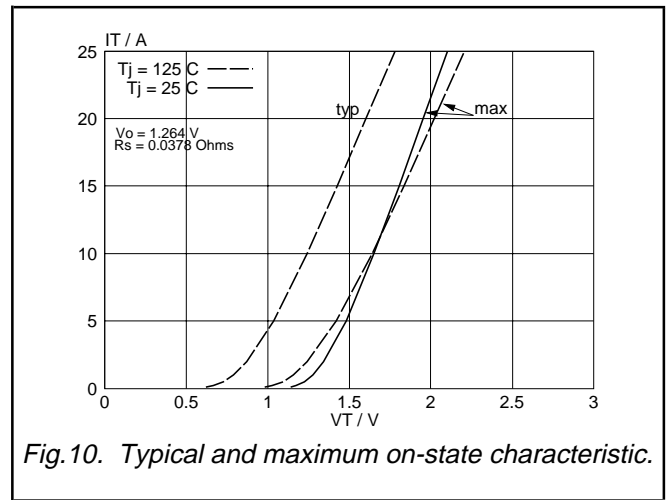
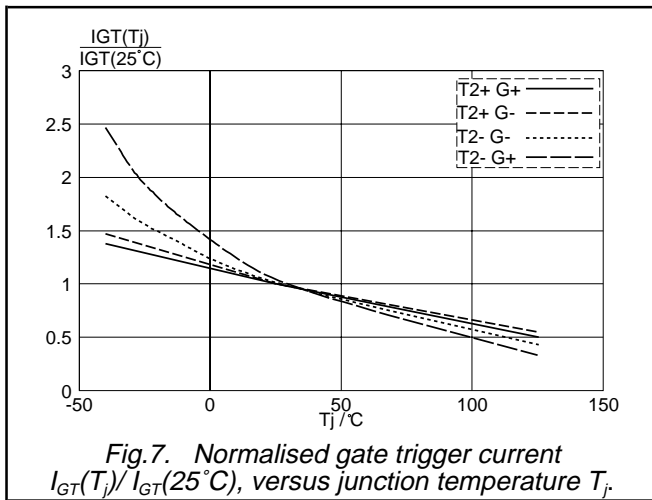

Fig.6. Normalised gate trigger voltage $V_{GT}(T_j) / V_{GT}(25^\circ\text{C})$, versus junction temperature T_j .

Triacs

BT137S series
BT137M series



Triacs

BT137S series
BT137M series

MECHANICAL DATA

Dimensions in mm

Net Mass: 1.1 g

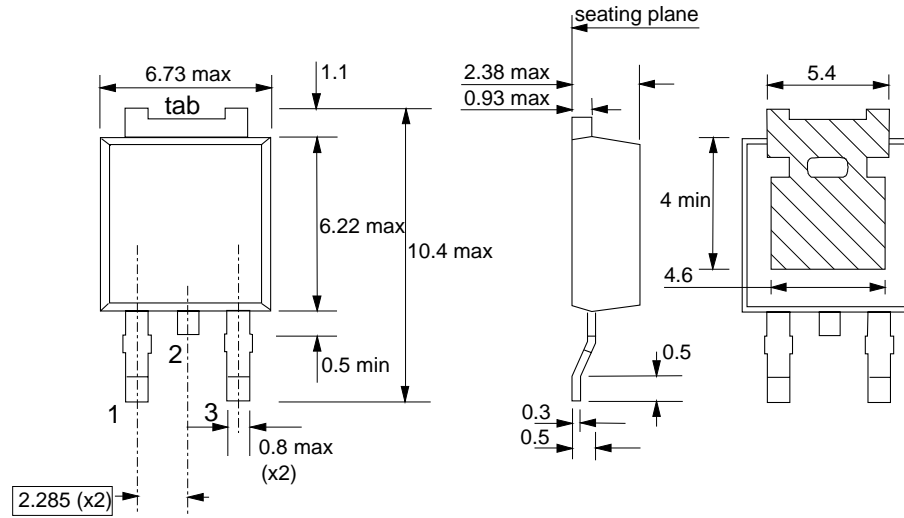

Fig.13. SOT428 : centre pin connected to tab.

MOUNTING INSTRUCTIONS

Dimensions in mm

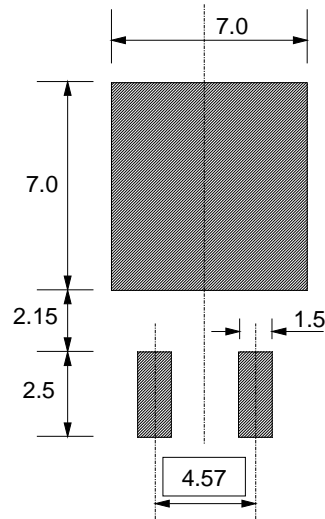

Fig.14. SOT428 : minimum pad sizes for surface mounting.

Notes

- 1. Plastic meets UL94 V0 at 1/8".

Triacs

BT137S series
BT137M series**DEFINITIONS**

Data sheet status	
Objective specification	This data sheet contains target or goal specifications for product development.
Preliminary specification	This data sheet contains preliminary data; supplementary data may be published later.
Product specification	This data sheet contains final product specifications.
Limiting values	
Limiting values are given in accordance with the Absolute Maximum Rating System (IEC 134). Stress above one or more of the limiting values may cause permanent damage to the device. These are stress ratings only and operation of the device at these or at any other conditions above those given in the Characteristics sections of this specification is not implied. Exposure to limiting values for extended periods may affect device reliability.	
Application information	
Where application information is given, it is advisory and does not form part of the specification.	
© Philips Electronics N.V. 1997	
All rights are reserved. Reproduction in whole or in part is prohibited without the prior written consent of the copyright owner.	
The information presented in this document does not form part of any quotation or contract, it is believed to be accurate and reliable and may be changed without notice. No liability will be accepted by the publisher for any consequence of its use. Publication thereof does not convey nor imply any license under patent or other industrial or intellectual property rights.	

LIFE SUPPORT APPLICATIONS

These products are not designed for use in life support appliances, devices or systems where malfunction of these products can be reasonably expected to result in personal injury. Philips customers using or selling these products for use in such applications do so at their own risk and agree to fully indemnify Philips for any damages resulting from such improper use or sale.