

---

# Flooring Installation and Care Instructions

---

# MEISTER Flooring Installation and Care Instructions

## Contents

<b>Laying instructions</b>	<b>6</b>
Preparatory measures, substrates and general instructions	6
<b>Laying instructions for Longlife parquet and Lindura wood flooring</b>	<b>8</b>
Longlife parquet and Lindura wood flooring with Mastercllic Plus technology	8
Longlife parquet Residence PS 500 with Quadrolic Plus technology	10
Longlife parquet Residence PS 400 with Uniclic technology	12
Longlife parquet Penta PD 550 with longitudinal Uniclic technology	14
<b>Laying instructions for Longlife parquet and Lindura wood flooring on walls</b>	<b>16</b>
Longlife parquet Penta PD 450, Cottage PD 400, Residence PS 300, Style PC 400, Classic PC 200, Classic PD 200 and Lindura wood flooring HD 400 with Mastercllic Plus technology	16
<b>Laying instructions for cork, linoleum, design, Nadura and laminate flooring</b>	<b>18</b>
Cork, linoleum, design, Nadura and laminate flooring with Mastercllic Plus technology	18
Laminate flooring with Multiclic technology	20
Design flooring with Multiclic technology	21
Design flooring with Maxiclic technology (MeisterDesign. life)	22
<b>Laying instructions for humid rooms</b>	<b>24</b>
Laminate flooring Melango, Micala and Talamo	24
Design flooring Catega® Flex, MeisterDesign. flex and MeisterDesign. comfort	25
<b>Mouldings and accessories</b>	<b>26</b>
Flooring profiles	26
Wall transitions   mouldings	28
Underlay materials	29
<b>Installation on warm water underfloor heating structures</b>	<b>30</b>
Longlife parquet	30
Lindura wood flooring	31
Cork flooring	32
Linoleum flooring	33
Design flooring	34
Nadura flooring	35
Laminate flooring	36
<b>Full surface bonding</b>	<b>37</b>
Longlife parquet, Lindura wood flooring and Nadura flooring	37
Design flooring MeisterDesign. life	38
Design flooring MeisterDesign. pro	39
<b>Cleaning and care instructions</b>	<b>40</b>
<b>Warranty conditions</b>	<b>46</b>

Quality starts with the installation.



You have purchased quality »Made in Germany«. For us, MEISTER quality is not just about the durability of your floor. It can also be seen during the installation of your floor. We rely on a middle layer of extremely stable HDF, special wood materials or the high-performance composite material ecuran for all our flooring types. And we use click systems, which are tailored to the properties of the flooring and dimensions of the planks, together with the patented Mastercllic Plus,

Quadrocllic Plus or Maxiclic system, which was developed within our own company, and the tried-and-tested Uniclic connection system. This ensures optimal precision of fitting that you can feel while installing your new flooring. MEISTER flooring is especially easy to install. That's why many craftsmen swear by products from MEISTER. You will find a lot of information about how to work with your MEISTER product in these installation and care instructions.



# Preparatory measures, substrates and general instructions

## Preparatory measures:

**The packages must be acclimatised before you open them. Store them unopened and lying flat on the ground for approx. 48 hours (in winter 3–4 days) / MeisterDesign. life und MeisterDesign. pro for approx. 24 hours (in winter 2 days) in the centre of the room you want to work in.** Do not store the packages in front of damp or freshly wallpapered walls. Before you install the flooring, outer doors and windows must be installed and all painting and decorating work must be finished. The room temperature must be approx. 20°C (at least 15°C), and the relative humidity must be approx. 30–65 percent.

The flooring requires a permanent living climate of approx. 30–65 percent relative humidity at a room temperature of 18–22°C. If you measure or anticipate a significantly lower humidity, you must install a humidifier (vapouriser) to prevent the flooring from drying out excessively.

Parquet, Lindura wood flooring, cork, linoleum and Nadura flooring are natural products. Therefore possible differences in colour and structure are an expression of its authenticity. Bleaching may occur with all flooring with direct sunlight or intense, artificial lighting. As a natural product, wood has hygroscopic properties. Dry cracks can appear as the wood expands/contracts, and are not due to faulty quality. In contrast to standard parquet floors, our Longlife parquet in a planked look has deliberately been produced at the factory with open joints and slits that underline the special character property. Before installation, check all planks in daylight for recognisable faults and damages, as well as colour and structure. Mix planks before laying so that you achieve the floor pattern and colour you want. You cannot make a claim for any products you have already installed.

## Important information about linoleum flooring

Drying chamber film: Linoleum is a product made from natural raw materials. It obtains the right proportional balance of elasticity and toughness in the drying chamber. During the drying process, a light yellow tinge forms on the surface of the material – this is called the drying chamber film. This film disappears under UV radiation (sunlight). How long that takes depends on the intensity of the sunlight. The flooring only develops its true colour after the film has disappeared. This effect is unavoidable

and an indicator of the natural substances used. Please note that the effect is more noticeable on light colours than on darker surfaces.

**Please be aware that our Silence »S« flooring collections already have the insulating underlay integrated into them.**

## Substrates

The substrates must be considered as ready-to-lay in accordance with the generally accepted rules of the trade, taking into account VOB (German Construction Contract Procedures), Part C, DIN 18 356 »Parquetry« or DIN 18 365 »Floor covering work« respectively.

Therefore they must be dry, even, solid and clean. The residual humidity, measured using the CM method, of mineral substrates must be no more than 2 percent (1.8 percent for underfloor heating) and that of anhydrite screeds must be a maximum of 0.5 percent (0.3 percent for underfloor heating). Any substrate unevenness of three or more millimetres for each initial metre and two or more millimetres for each subsequent continuous metre must be evened out according to DIN 18 202, table 3, line 4. We recommend consulting technical information sheet 02 from the Zentralverband für Parkett und Fußbodentechnik (Central Association for Parquet Flooring and Flooring Technology) and the BEB (German Federal Association of Screed and Floor Covering). For MeisterDesign. life, joints in old ceramic subfloors wider than 7mm and more than 2mm deep must be levelled using suitable filler materials. 0.2mm thick PE film (SD value  $\geq 75\text{m}$ ) must be laid out on all mineral substrates (except poured asphalt screed) as a vapour barrier. The strip edges must overlap by at least 20 centimetres and the overlapping edges must be glued to the side walls. A vapour barrier is not required for waterproof MeisterDesign. life.

In rooms that are not above a cellar and foundations, the currently valid building conditions require that the owner of the building provide a barrier against damage to the base plate due to moisture from the ground, in accordance with the DIN 18 195 directive.

MEISTER flooring can be laid on existing surfaces, such as plastic, ceramic tiles and boards or stone floors, so long as the old flooring is firmly bonded and there are no loose areas. You should also spread out a film on these subfloors as a separating layer. On existing wooden planks, wood-based boards, OSB-boards,

drywall elements etc., no vapour barrier must be used. Textile flooring such as, e.g. carpet or needle fleece must be removed not only for technical reasons, but for hygiene reasons too.

## General information

**MEISTER flooring is not suitable for installation in humid rooms/wet areas (bathrooms, saunas, swimming pool etc.). The design floorings Catega® Flex, MeisterDesign. flex, MeisterDesign. comfort and the laminate floorings Melango, Micala, Talamo and the waterproof design floorings MeisterDesign. life and MeisterDesign. pro can be installed in humid rooms (Class W0-I, e.g. bathrooms; for life and pro class W1-I). They are not suitable for installation in outdoor areas or wet rooms such as showers, saunas, public washrooms or rooms with a floor drain – see page 22, 24 and 25.**

MEISTER flooring is installed as a floating floor, without glue. MeisterDesign. pro flooring is exclusively intended for full-surface bonding. Some other types of flooring can also be installed with full surface bonding using an approved adhesive as an alternative to floating installation; see pages 37–39.

The various click systems are tailored to the properties of the respective flooring and the dimensions of the planks. The Masterclik Plus connection system makes it possible to install the flooring quickly and easily. The end interlocking occurs when the next row is laid. In addition, it is a valuable installation aid, as the planks can be aligned against each other in this way. To do this, you should lift the plank slightly and square it quite easily with the tongue in the groove of the plank which has already been laid.

If the floor area is longer or wider than 10m (for MeisterDesign. life: longer or wider than 15m), then you must provide an expansion joint. Cover this with a transition profile. It is also important to provide these joints between two adjacent rooms, in doorways, passageways and rooms with a lot of angles.

Always use a jointing profile for clean transitions to adjacent, lower areas or floor coverings and an end profile next to higher adjacent thresholds, tiles or the like. Give stairs a clean finish with the stair edge profile.

During installation, take care to leave a gap of at least 10 or 1.5mm per metre (15mm for

parquet flooring and Lindura wood flooring; 5mm for MeisterDesign. life) next to all walls. This distance must also be left around all columns, heating pipes, steel door frames, etc. It may be possible to shorten wooden door frames. To do this, lay a loose plank with the decorative side down against the door frame and saw the frame off along the plank.

To protect the wood from dirt, a sufficiently large entrance covering must always be laid (e.g. a doormat, carpet). Do not use any rubber-coated mats, since prolonged contact can lead to permanent discolouration, especially in design flooring. In addition, you should also fit chair and furniture feet with felt sliders; office chairs, mobile containers, etc., on castors must be equipped with soft, standard running surfaces (type W). Coloured rubber, natural rubber or plastic glides and castors as well as dark car, bike or equipment tyres may possibly cause discolouration on design flooring. Please only use light, non-migrating furniture glides, castors or tyres, if possible. We recommend protecting the floor in these heavy wear areas with appropriate floor protection mats (e.g. polycarbonate mats).

With design, cork and linoleum flooring, contact areas for heavy furnishings (e.g. pieces of furniture) should be increased using pressure distribution plates to prevent imprints and damage.

MEISTER Nadura floors have an extremely durable and highly wear-resistant surface. Visible signs of wear or shiny/glossy areas are characteristic of hard wood flooring, depending on wear.

We recommend that you install the planks lengthways to the way the light falls. In narrow or long rooms, choose the laying direction to suit the room's proportions. Lay the planks crossways to make narrow rooms look more spacious; planks laid lengthways narrow hallways.

Please first check whether a subfloor is required as explained in "Substrates". Furthermore, if you are using products without a sound-absorbing Silence cushion, use the system-bound MEISTER insulating underlay. (If you use MEISTER-Silence 25 DB, MEISTER-

Silence 15 DB, or MEISTER-Twin Control, an additional 0.2mm PE film is not required.)

**Other insulating underlay needs to have a corresponding compressive strength (CS value  $\geq 15\text{kPa}$ ,  $\geq 60\text{kPa}$  in commercial areas with heavy wear) and a thickness of 1–3mm.**

**For MEISTER design flooring Catega® Flex DD 300 and Meister-Design. flex DD 400/DB 400, a compressive strength of  $\geq 60\text{kPa}$  is generally required.**

**For MeisterDesign. life DD 800/DB 800, only the insulating underlay designed for this system, MEISTER-SilenceGrip (CS value  $> 400\text{ kPa}$ ), may be used.**

**Other types of insulating underlay must meet the increased requirements in accordance with the technical bulletin "TM 1" from MMFA for Class 2 floor coverings.**

When sawing the elements, make sure you work from the correct side: if you use a bench saw, keep the wear layer side facing up if you use a keyhole or portable circular saw, keep the wear layer side down.

**For laying Lindura wood flooring and Nadura floors hard metal saw blades or diamond tipped saw blades are required.**

# MEISTER Longlife parquet and Lindura wood flooring with Mastercllic Plus technology



**You need the following tools and aids to install MEISTER Longlife parquet and Lindura wood flooring with Mastercllic Plus technology.**

Keyhole or electric saw (for Lindura wood flooring hard metal saw blades or diamond tipped saw blades), possibly power drill, folding metre rule, pencil, wedges (spacer wedges), angle or adjustable bevel, possibly PE film (0.2mm).

Use MEISTER foam film, MEISTER-Silence 15 DB, MEISTER-Silence 20, MEISTER-Silence 25 DB, or MEISTER-Twin Control as a cushioning layer. (When using MEISTER-Silence 25 DB, MEISTER-Silence 15 DB or MEISTER-Twin Control, an additional 0.2mm PE film is not required.)

## Step 1

Start by laying the first complete plank in the left-hand corner of the room with the tongue sides facing the wall. Remove only the tongues on the long sides of all the other planks you want to lay in the first row. Using wedges, you can easily keep a gap of at least 15mm from the wall (fig. 1).

## Step 2

Insert the end of the next complete plank into plank no. 1 (fig. 2). Install the other planks in this row in exactly the same way across the entire width of the room.

## Step 3

Cut the last plank in each row so that you leave a gap of at least 15mm to the wall (fig. 3). You can use cut-off pieces of planks, as long as they are at least 40 centimetres long, to start subsequent rows.

## Step 4

Make sure that the planks in the first row are straight. Cut the first plank in the second row to approx. 80 centimetres.

Fix this plank upright with the spring as far as possible into the groove on the groove side of the previous row of planks and press the plank down slowly, using a forward and downward turning motion (fig. 4). The plank should lock into the previously laid row (fig. 5).

## Step 5

Similarly, the next complete plank is turned into the click connection on the long side and the end pushed tight against the previous plank before it is lowered. Then press the plank down slowly, using a forward and downward turning motion (fig. 6). The plank has to click into the previously installed row and the end joint with the previous plank has to be closed.

## Step 6

Continue installing the panels row by row in this way. Remember that the end joints must be offset by at least 40cm (fig. 7).

## Step 7

To cut the last row to size, use a spare piece of plank and draw the remaining plank width on it (leaving a gap of at least 15mm to the wall).

## Step 8

Taking the plank marked for width, push the plastic end tongue forward out of the end groove with the aid of a spare piece of plank (fig. 8).

## Step 9

Begin cutting the plank to size at the end of the plastic tongue (fig. 9). After the plank has been cut to size, push the plastic tongue on the end back into the end groove (fig. 10).

## Step 10

Begin laying the last row in the right hand corner of the room (leaving at least a 15mm gap to the wall) and angle the sides of the plank into the second-last row. The next plank is pivoted in the same way and lowered down at the end (fig. 11).

## Step 11

Push the plastic tongue which is pointing out towards the wall (fig. 12) back into the end connection using a tension rod, scraper, screw driver or similar (fig. 13).

## Step 12

You have to remove the wooden wedges along the walls before attaching the skirting boards.

To cover the all-round expansion joints, use MEISTER real wood veneered skirting boards (see page 28).

Please avoid any silicon products coming into contact with the mouldings.

**To take a plank row back out again,** lift the entire row, levering it at the side out of the last row (fig. 14). Then you can separate the planks' ends by angling them (fig. 15). Should you wish to reuse the disassembled planks, you should push the end plastic spring tongue back into the top groove.

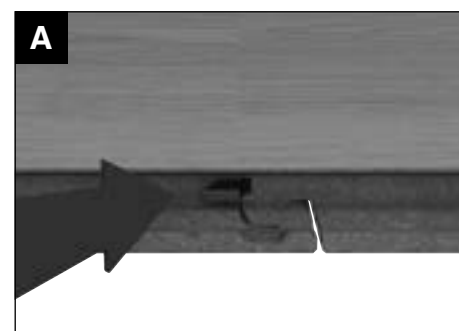
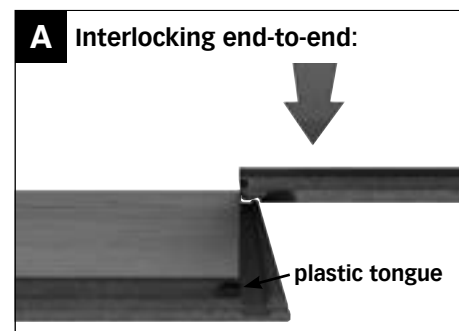
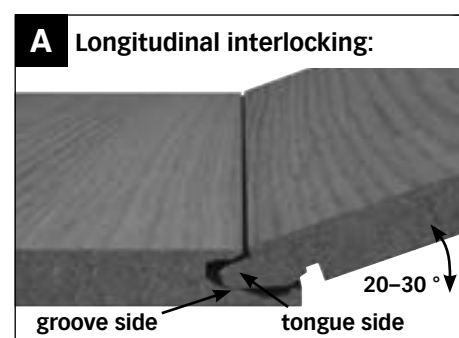



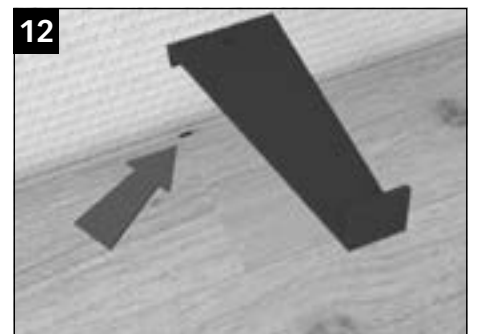
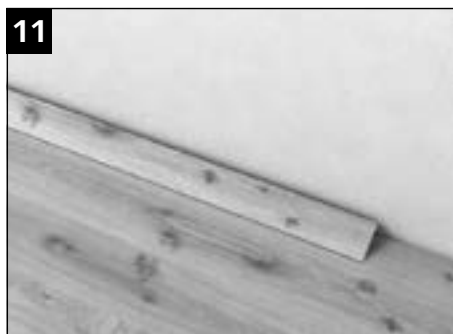
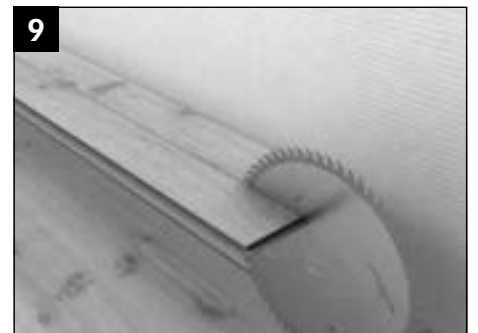
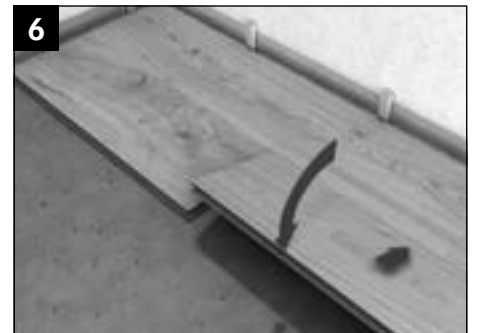
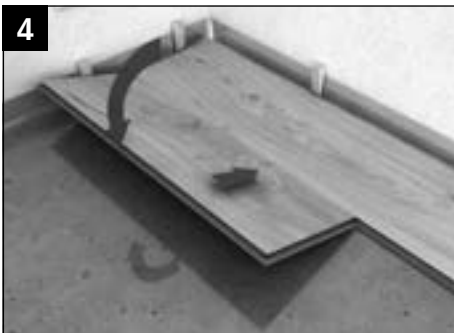

# MEISTER Longlife parquet Residence PS 500 with Quadroclit Plus technology

QUADROCLITPLUS®

## You need the following tools and aids to install MEISTER Longlife parquet flooring PS 500 with Quadroclit Plus technology:

MEISTER herringbone template, hammer, keyhole or electric saw, possibly power drill, folding metre rule, pencil, MEISTER "Quadroclit" tapping block, wedges (spacer wedges), tension rod, angle or adjustable bevel, possibly PE film (0.2 mm). Use the MEISTER-Silence 15 DB, MEISTER-Silence 20 or MEISTER-Silence 25 DB as an insulating underlay to absorb footfall noise (when using MEISTER-Silence 25 DB or MEISTER-Silence 15 DB an additional 0.2mm PE film is not required).

## General information

The Quadroclit Plus click connection (fold down system) allows you to work quickly and safely and produce different laying patterns, e.g. an irregular lattice, regular lattice, herringbone look or even square, ladder or braid pattern. Generally the longitudinal sides are angled in (fig. I) and the ends are lowered (fig. II) and instantly locked by applying pressure from above. The planks can be angled in and pivoted out both longitudinally and at the ends. In addition, it may be necessary to tap both the end and longitudinal joints together using the matching "Quadroclit" tapping block, e.g. in specific installation situations such as in the area around door frames etc. It may also be required to remove the plastic tongue here. If you want to reuse the disassembled planks, you have to manually reinsert the plastic tongue into the middle of the groove again (fig. III).

**There are 4 planks each labelled type A and type B on the back (fig. IV) in every packet.**

## Installing a parallel herringbone lattice

If you want a symmetrical installation pattern, you have to join the rows accordingly.

### Step 1

Start the installation in the left-hand corner of the room using the planks labelled type A. The plastic tongues must be facing the left-hand wall. In the first row the type A plans are joined longitudinally with an offset end of exactly 142 mm. You can also use the MEISTER herringbone template for the precise offset (fig. 1).

### Step 2

Please note, the first row has to be completely cut to size and installed first. Using the wedges you can easily keep a gap of at least 15mm to the wall (fig. 2). The leftover pieces of planks there can possibly be used at the start of the next herringbone. Mark the off-cut pieces A or B accordingly on the back.

### Step 3

The second row is then installed using the type B planks. Each plank is angled-in longitudinally and lowered at the end (fig. 2). The plastic tongue clicks in when a bit of pressure is applied from above.

### Step 4

Install the entire area up to the end of the room in this order (fig. 3). The planks that end at the wall are cut to size so that a gap of 15mm to the wall is taken into account. When installing in a different direction or with specific room situations, the longitudinal sides and ends can be tapped together using the "Quadroclit" tapping block. When tapping the plastic tongues flat into the appropriate grooves, the element has to be clicked in again by applying pressure or tapping from above, once the end joint is closed.

### Step 5

You have to remove the wooden wedges along the walls before attaching the skirting boards. To cover the all-round expansion joints, use MEISTER real wood veneered skirting boards (see page 28). Please avoid any silicon products coming into contact with the mouldings.

## Diagonal herringbone lattice

If you want a symmetrical installation pattern, you have to join the rows accordingly.

### Step 1

Start the installation using the planks labelled type A. The longitudinal tongues must be facing the wall. In the first row the type A plans are joined longitudinally with offsetting of the end joints of exactly 142 mm. You can also use the MEISTER herringbone template for the precise offset (fig. 1).

### Step 2

Please note, the first row has to be completely cut to size and installed first. Using wedges, you can easily keep a gap of at least 15mm to the wall (fig. 1).

### Step 3

The second row is then installed using the type B planks. Each plank is angled-in longitudinally and lowered at the end (fig. 2). The plastic tongue clicks in when a bit of pressure is applied from above.

### Step 4

Install the entire area up to the end of the room in this order (fig. 3). The planks that end at the wall are cut to size so that a gap of 15mm to the wall is taken into account. The leftover pieces of planks there can possibly be used at the start of the next herringbone. Mark the off-cut pieces A or B accordingly on the back. When installing in a different direction or with specific room situations, the longitudinal sides and ends can be tapped together using the "Quadroclit" tapping block. When tapping the plastic tongues flat into the appropriate grooves, the element has to be clicked in again by applying pressure or tapping from above, once the end joint is closed.

### Step 5

You have to remove the wooden wedges along the walls before attaching the skirting boards. To cover the all-round expansion joints, use MEISTER real wood veneered skirting boards. Please avoid any silicon products coming into contact with the mouldings.

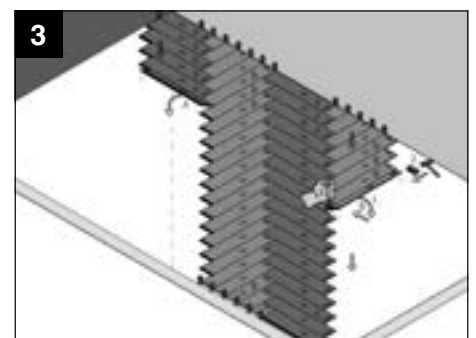
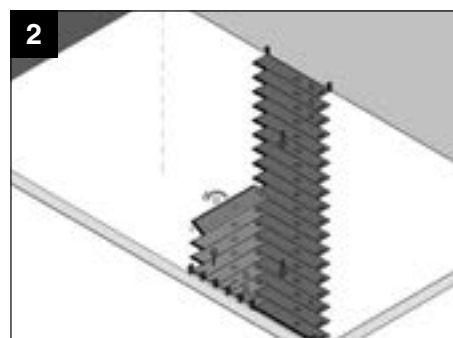
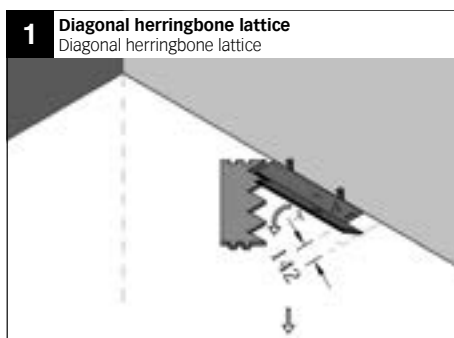
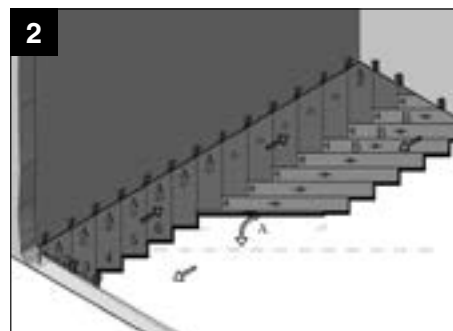
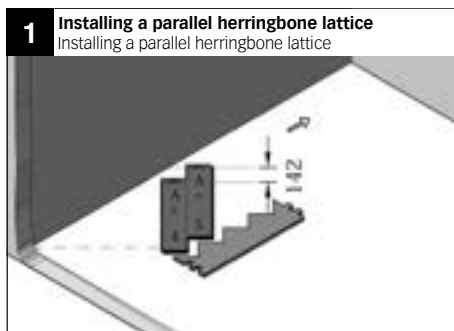
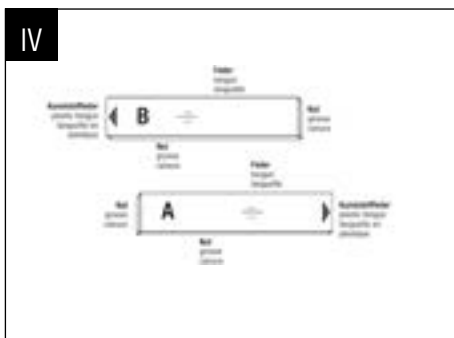
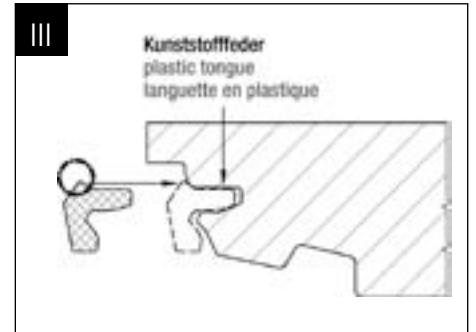
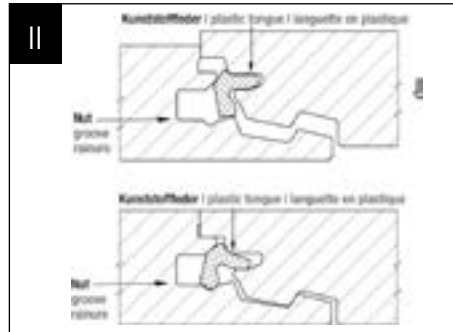
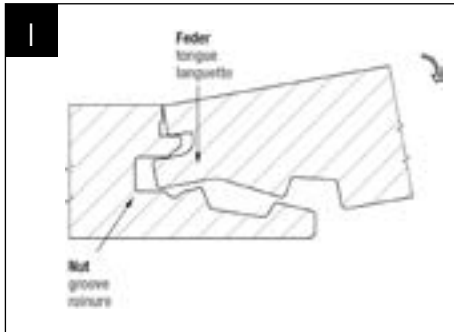

# MEISTER Longlife parquet Residence PS 400 with Uniclic technology

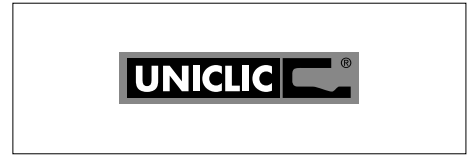

## You need the following tools and aids to install MEISTER Longlife parquet PS 400 with Uniclic technology

Hammer, keyhole or electric saw, possibly power drill, folding metre rule, pencil, MEISTER tapping block, wedges (spacer wedges), tension rod, angle or adjustable bevel, possibly PE film (0.2mm).

Use MEISTER foam film, MEISTER-Silence 15 DB, MEISTER-Silence 20, MEISTER-Silence 25 DB, or MEISTER-Twin Control as a cushioning layer. (When using MEISTER-Silence 25 DB, MEISTER-Silence 15 DB or MEISTER-Twin Control, an additional 0.2mm PE film is not required.)

## Diagonal herringbone lattice

In order to obtain a uniform distance to all walls, draw a guide line using a chalk line (fig. 1). Start the laying process in a corner of the room. The tongue of board 1 has to be cut off both on the short and on the long side. On board 2, only the tongue on the long side has to be cut off. Now angle the short side of board 2 into the long side of board 1 (fig. 1). Then angle the long side of board 3 into board 1 (fig. 2). Now interlock the short side of board 3 using the MEISTER tapping block into board 2 (fig. 3). Follow this process to continue laying (fig. 4, 5, 6). Make sure that the long sides of the boards are angled in first before interlocking the boards on their short sides.

Lay the first herringbone pattern up to the wall/corner of the room (fig. 7). The leftover pieces of planks there can possibly be used at the start of the next herringbone. Mark the leftover pieces on the reverse side indicating right or left positioning. The first herringbone pattern has to be fixed with spacers so that the herringbone pattern does not slide during the subsequent laying process.

Before starting with the next herringbone pattern, check if there are any leftover pieces that could be used. While continuing with the laying, ensure that the long sides of the boards are angled in first and only then interlock them short sides (fig. 8).

Following this sequence, lay the surface up to the end of the room (fig. 9). The planks that end at the wall are cut to size so that a gap of 15mm to the wall is taken into account.

## Parallel herringbone pattern

In order to obtain a uniform distance to all walls, draw a guide line using a chalk line (fig. 6). Start the laying process in the middle of the room facing a wall. Angle the short side of board 2 into the long side of board 1 (fig. 1). Then angle board 3 lengthways into board 1 (fig. 2). Now interlock the short side of board 3 using the MEISTER tapping block into board 2 (fig. 3). Follow this process to continue laying up to board 11 (fig. 4, 5, 6).

Saw off the laid boards at a right angle and then align them at the guide line (fig. 6).

Make sure that the long sides of the boards are angled in first before interlocking the boards on their short sides.

Lay the first herringbone pattern up to the facing wall (fig. 7). The leftover pieces of planks there can possibly be used at the start of the next herringbone. Mark the leftover pieces on the reverse side indicating right or left positioning. The first herringbone pattern has to be fixed with spacers so that the herringbone pattern does not slide during the subsequent laying process.

Before starting with the next herringbone pattern, check if there are any leftover pieces that could be used. While continuing with the laying, ensure that the long sides of the boards are angled in first and only then interlock them short sides (fig. 8).

Following this sequence, lay the surface up to the end of the room (fig. 9). The planks that end at the wall are cut to size so that a gap of 15mm to the wall is taken into account.

You have to remove the wooden wedges along the walls before attaching the skirting boards.

To cover the all-round expansion joints, use MEISTER real wood veneered skirting boards (see page 28).

Please avoid any silicon products coming into contact with the mouldings.

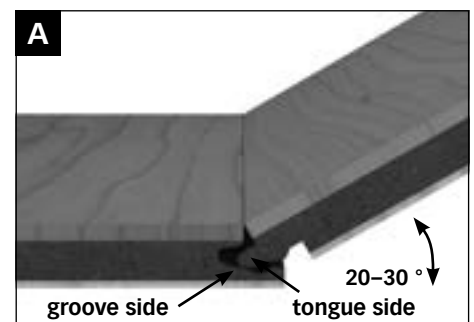

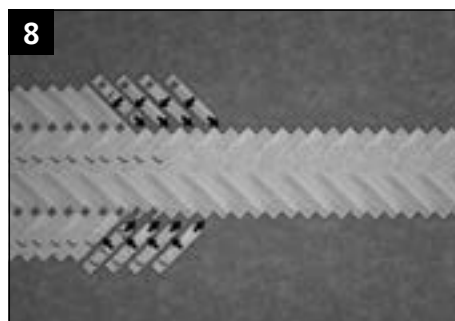
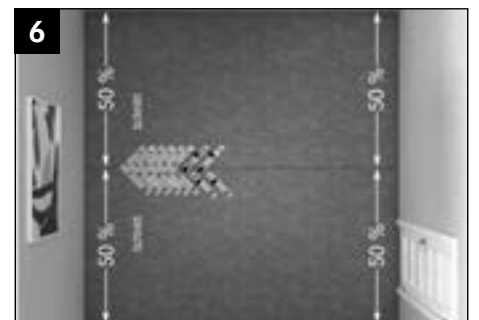
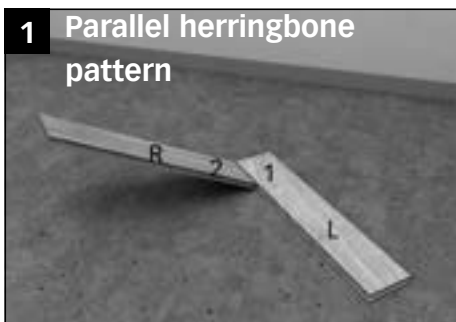
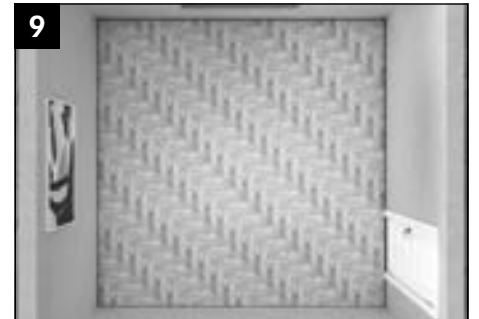
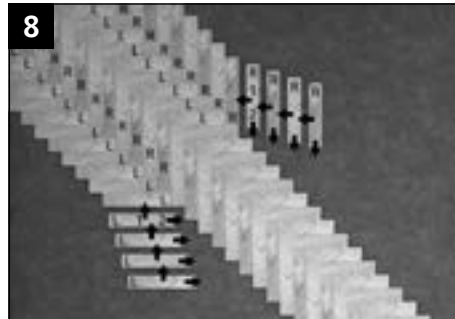
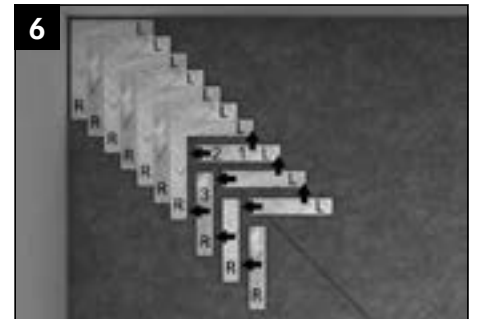

# MEISTER Longlife parquet Penta PD 550 with longitudinal Uniclic technology

**You need the following tools and aids to install MEISTER Longlife parquet PD 550 with longitudinal Uniclic technology:**

Hammer, keyhole or electric saw, possibly power drill, folding metre rule, pencil, MEISTER tapping block, wedges (spacer wedges), tension rod, angle or adjustable bevel, possibly PE film (0.2mm), possibly D3 waterproof wood glue for naturally oiled parquet flooring or Meistercoll special glue for UV-oiled parquet flooring.

For sound insulation, we recommend MEISTER-Silence 25 DB.

**General information:**

**The planks have a tongue and groove joint on each end. These joints must always be glued.** To do this, apply glue evenly to the bottom edge of the groove (fig. B). Please take care that no glue gets onto the wear layer. If any glue oozes out from the joint, remove it at once with a clean, damp cloth. Due to the different widths of plank, an installation plan must be compiled before laying the floor to avoid unnecessary cutting.

**Step 1**

Start by laying the first complete plank in the left-hand corner of the room with the tongue sides facing the wall. Saw the tongues off the long edges of the first row of planks to ensure you keep the right gap to the wall. Using wedges, you can easily keep a gap of 15mm from the wall (fig A1).

**Step 2**

Insert the end of the next complete plank into plank 1 using a hammer and tapping block (fig. 2). To do this, first apply glue evenly to the bottom edge of the groove (fig. B). Install the other planks in this row in exactly the same way across the entire width of the room. Join the last piece of plank using a tension rod.

**Step 3**

Make sure the planks in the first row are straight. Remember that the end joints must be offset by at least 40cm. Then place the next plank against row 1 and press the plank down slowly, using a forward and downward turning motion. (fig. 3). The plank should lock into the previously laid row (fig. 4).

**Step 4**

Similarly, the next complete plank is turned into the click connection on the long side and pushed tight against the previous plank before it is lowered. (fig. 5).

**Step 5**

Then press the plank down slowly, using a forward and downward turning motion (fig. 6). The plank has to click into the previously installed row.

**Step 6**

Insert the end of this plank into the previous plank and ensure the joint is tight with a hammer and tapping block (fig. 7). To do this, first apply glue evenly to the bottom edge of the groove (fig. B). Continue in this way across the entire width of the room.

**Step 7**

Continue installing the panels row by row in this way. Remember that the end joints must be offset by at least 40cm. The last planks in each row are cut to size so that a gap of 15mm to the wall is taken into account. To cut the last row to size, use a spare piece of plank and draw the remaining plank width on it (leaving a gap of at least 15mm to the wall). Join the last piece of plank using a tension rod.

**Step 8**

You have to remove the wooden wedges along the walls before attaching the skirting boards.

To cover the all-round expansion joints, use MEISTER real wood veneered skirting boards (see page 28).

Please avoid any silicon products coming into contact with the mouldings.

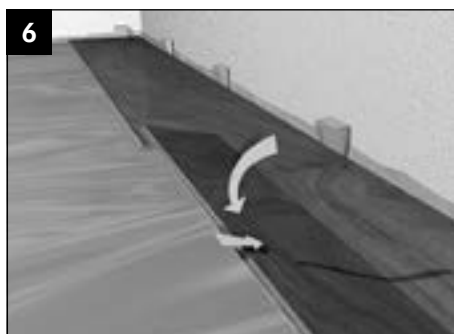
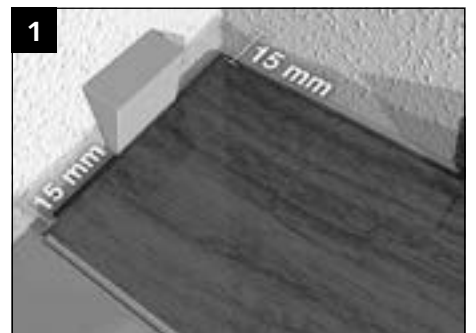
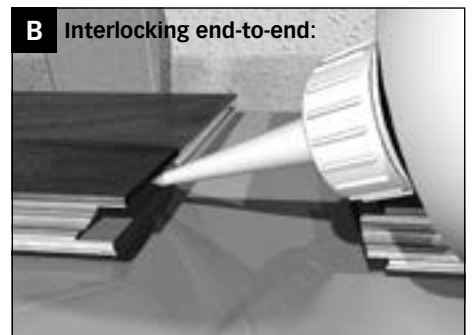
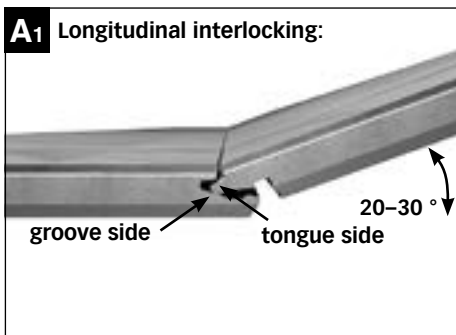

# Laying instructions for fastening Longlife parquet Penta PD 450, Cottage PD 400, Classic PD 200, PC 200, Residence PS 300, Style PC 400 (clip TOP 13) Lindura wood flooring HD 400 (clip TOP 11) to the wall

---

## Preparatory measures:

The packages must be acclimatised before you open them. Store them for approx. 48 hours (3-4 days in winter) flat on the floor in the centre of the room you want to work in. Do not store the packages in front of damp or freshly wallpapered walls. Before you install the planks, the conditions must comply with the general requirements for the installation of wooden materials in interior rooms. Make sure that the walls are dry, i.e. contain a maximum residual moisture of 5 percent. All windows and doors must also have been installed and a room temperature of approx. 20°C and approx. 30 – 65 percent relative humidity must prevail.

During installation, make sure that air can also circulate behind the wood panelling (possibly provide lath backing structure). You must avoid trapped air. It is also important during installation that you allow a gap of at least 10 – 15 mm next to all walls and other fixed elements. You need an expansion joint if your installation surface is longer or wider than 10 metres.

## Sub-structure with batten profile type 8

Place the batten profile type 8 at maximum intervals of 40 centimetres apart (fig. 1). Please use suitable plugs or screws to screw the sub-structure to the wall at intervals of 50 cm. Correct any slight unevenness in the wall by placing spacers or wooden wedges underneath the laths. Use a standard metal hacksaw or one-hand angle grinder with metal cutting disc to trim the profile. A minimum gap of 20 mm is required when installing MEISTER recessed lights. This must be guaranteed by fixing the batten profile to the wall using a space of at least 12 mm.

## Installation

As a result of the Masterclip Plus system the planks are installed from right to left (fig. 9). Start by laying the first complete plank with the tongue side facing the floor. With all the planks in the first row remove the tongues along the long edges.

To install the first row use the start/end clip. To fix these mark the profile's position on the back of the plank. The middle of the rail is marked using a pencil (fig. 2) and the start/end clip is fixed using the supplied screws (fig. 3). Tighten the screws but do not over tighten them. Then simply clip the plank into the batten profile (fig. 4). If the clip does not slot in correctly then the profile may have been pressed together during trimming. In this case please bend open the profile to its original dimensions again.

Use the TOP 13|TOP 11 clip to fix the planks for the rest of the installation. For this simply screw the clip onto the batten profile (fig. 5) and push it onto the plank groove (fig. 6 + 7). Make sure that the planks in the first row are straight.

Angle the tongue of the first plank in the second row into the groove of the previous row of planks (fig. 8) and slowly press the planks onto the batten profile. Use the TOP 13|TOP 11 clip to fix the planks for the rest of the installation (fig. 7). Continue installing the planks row by row in this way (fig. 10).

To cut the last row to size, use a spare piece of plank and draw the remaining plank width on it (leaving a gap of 10-15 mm to the ceiling).

Taking the plank marked for width, push the plastic end tongue forward out of the end groove using the spare piece of plank (fig. 11). Begin cutting the plank to size at the end of the plastic tongue. After the plank has been cut to size, push the plastic tongue on the end back into the end groove (fig. 12 + 13).

To install the start/end clips on the last row mark the position of the batten profile using a piece of adhesive tape (fig. 14) and transfer the position of the profile onto the back of the plank (fig. 15 + 16). Now the clip is fixed on the plank in the first row (fig. 17) and inserted into the plank (fig. 18). Afterwards the plastic tongue in the last row must be fixed using a screwdriver (fig. 19).

Use the MEISTER angled cover moulding for example to cover the all-round expansion joints (fig. 20 + 22).





Fig. 1



Fig. 2



Fig. 3



Fig. 4



Fig. 5



Fig. 6



Fig. 7



Fig. 8



Fig. 9

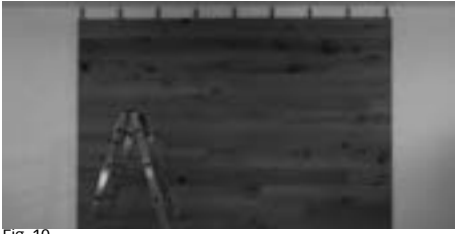

Fig. 10



Fig. 11



Fig. 12



Fig. 13



Fig. 14



Fig. 15



Fig. 16



Fig. 17



Fig. 18



Fig. 19



Fig. 20



Fig. 21



Fig. 22

# MEISTER cork, linoleum, design, Nadura and laminate flooring with Mastercllic Plus technology



**You need the following tools and aids to install MEISTER cork, linoleum, design, Nadura and laminate flooring with Mastercllic Plus technology:**

Keyhole or electric saw (**for Nadura flooring hard metal saw blades or diamond tipped saw blades**), possibly power drill, folding metre rule, pencil, wedges (spacer wedges), angle or adjustable bevel, possibly PE film (0.2mm). If the product does not already have a sound-absorbing cushion, you have to use MEISTER foam film, MEISTER-Silence 15 DB, MEISTER-Silence 20, MEISTER-Silence 25 DB or MEISTER-Twin Control as a cushioning layer. (When using MEISTER-Silence 25 DB, MEISTER-Silence 15 DB or MEISTER-Twin Control, an additional 0.2mm PE film is not required.)

### Step 1

Start by laying the first complete plank in the left-hand corner of the room with the tongue sides facing the wall. Remove only the tongues on the long sides of all the other planks you want to lay in the first row. Using wedges, you can easily keep a gap of at least 10mm or 1.5mm per metre from the wall (fig.1).

### Step 2

Insert the end of the next complete plank into plank No. 1 (fig. 2). Install the other planks in this row in exactly the same way across the entire width of the room.

### Step 3

Cut the last plank in each row so that you leave a gap of at least 10mm to the wall (fig. 3). You can use cut-off pieces of planks, as long as they are at least 40 centimetres (with Nadura flooring NB 400, laminate flooring Classic LB 85, MeisterDesign. comfort DB 600 S and cork flooring KC 85 S 30 centimetres) long, to start subsequent rows.

### Step 4

Make sure that the planks in the first row are straight. Cut the first plank in the second row to approx. 80 centimetres (with Nadura flooring NB 400, laminate flooring Classic LB 85, MeisterDesign. comfort DB 600 S and cork flooring Classic KC 85 S to approx. 50-60 centimetres). Fix this plank upright with the spring as far as possible into the groove on the groove side of the previous row of planks and press the plank down slowly, using a forward and downward turning motion (fig. 4). The plank should lock into the previously laid row (fig. 5).

### Step 5

Similarly, the next complete plank is turned into the click connection on the long side and the end pushed tight against the previous plank before it is lowered. Then press the plank down slowly, using a forward and downward turning motion (fig. 6). The plank has to click into the previously installed row and the end joint with the previous plank has to be closed.

### Step 6

Continue installing the panels row by row in this way. Remember that the end joints must be offset by at least 40cm (with Nadura flooring NB 400, laminate flooring Classic LB 85, MeisterDesign. comfort DB 600 S and cork flooring Classic KC 85 S 25cm) (fig. 7).

### Step 7

To cut the last row to size, use a spare piece of plank and draw the remaining plank width on it (leaving at least a gap of 10mm or 1.5mm per metre to the wall).

### Step 8

Taking the plank marked for width, push the plastic end tongue forward out of the end groove with the aid of a spare piece of plank (fig. 8).

### Step 9

Begin cutting the plank to size at the end of the plastic tongue (fig. 9). After the plank has been cut to size, push the plastic tongue on the end back into the end groove (fig. 10).

### Step 10

Begin laying the last row in the right hand corner of the room (leaving at least a gap of 10mm or 1.5mm per metre to the wall) and angle the sides of the plank into the second-last row. The next plank is pivoted in the same way and lowered down at the end (fig. 11)

### Step 11

Push the plastic tongue which is pointing out towards the wall (fig. 12) back into the end connection using a tension rod, scraper, screw driver or similar (fig. 13).

### Step 12

You have to remove the wooden wedges along the walls before attaching the skirting boards.

To cover the all-round expansion joints, use MEISTER skirting boards with colour-matching decorative surfaces (see page 28). Please avoid any silicon products coming into contact with the mouldings.

**To take a plank row back out again**, lift the entire row, levering it at the side out of the last row (fig. 14). Then you can separate the planks' ends by angling them (fig. 15). Should you wish to reuse the disassembled planks, you should push the end plastic spring flush back into the top groove.

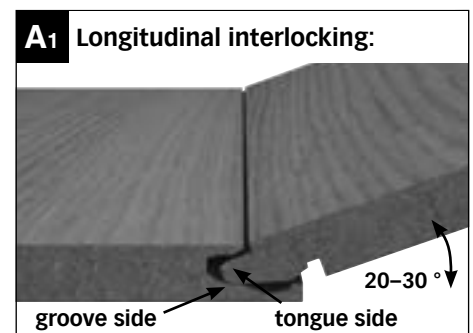

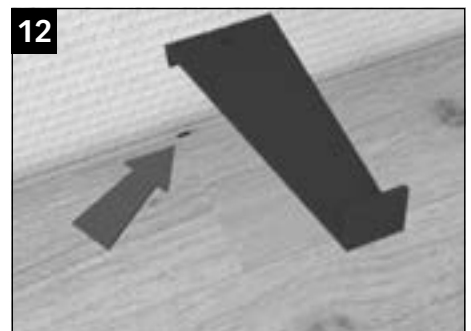
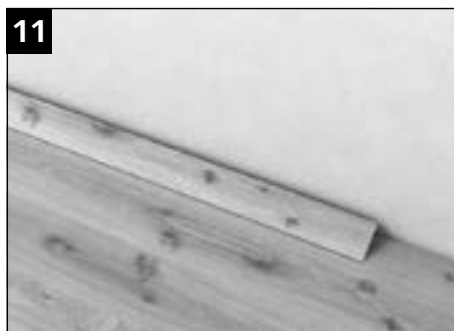
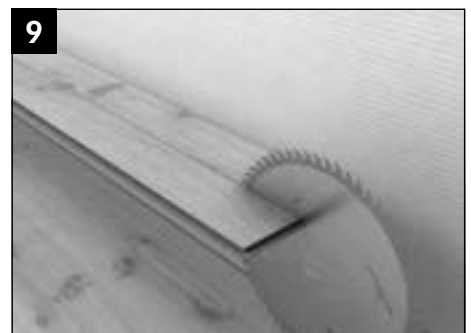
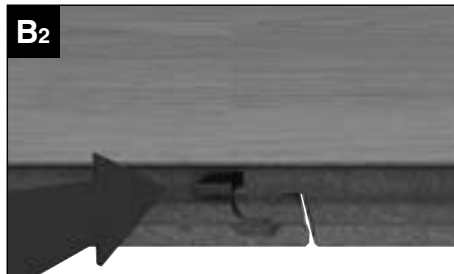
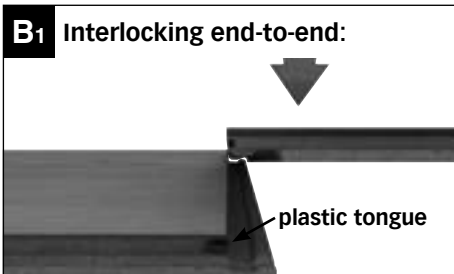

# MEISTER laminate flooring with Multiclic technology



**You need the following tools and aids to install MEISTER laminate flooring with Multiclic technology:**

Hammer, keyhole or electric saw, possibly power drill, folding metre rule, pencil, wedges (spacer wedges), tension rod, angle or adjustable bevel, MEISTER tapping block, possibly PE film (0.2mm).

If the product does not already feature a sound-absorbing cushioning, use MEISTER foam film, MEISTER-Silence 15 DB, MEISTER-Silence 20, MEISTER-Silence 25 DB or MEISTER-Twin Control as a cushioning layer. (When using MEISTER-Silence 25 DB, MEISTER-Silence 15 DB or MEISTER-Twin Control, an additional 0.2mm PE film is not required.)

**Step 1**

Start by laying the first complete plank in the left-hand corner of the room with the tongue sides facing the wall. Saw the tongues off the first plank, both on the short and the long side (fig. E). Remove only the tongues on the long sides of all the other planks you want to lay in the first row. Using wedges, you can easily keep a gap of at least 10mm or 1.5mm per metre from the wall.

**Step 2**

Join the next complete plank to the end of plank 1 using a tapping block and a hammer. Install the other planks in this row in exactly the same way across the entire width of the room. Wherever space is too tight to work with a hammer and tapping block, you can use a tension rod to help click the end joint in place.

**Step 3**

Make sure the planks in the first row are straight (fig. A). Cut the first plank of the second row down to approx. 80cm. To install the second row, insert the long tongue into the groove of the first row of planks (fig. B, ①).

**Step 4**

By moving the plank slightly up and down, angle it completely into the already laid row of planks (fig. B, ②).

**Step 5**

Again, angle the next complete plank of the second row first on its long edge against the previously laid plank. Always make sure the long joint is tight. Once you have angled in the planks (fig. C, ① and ②) so they lie flat on the subfloor, click the ends together using the tapping block and light taps with the hammer (fig. C, ③).

**Step 6**

Continue installing the panels row by row in this way. Install the planks row by row until you have covered the whole room – always first fitting the long tongue into the groove and then joining the plank ends together. Remember that the end joints must be offset by at least 40cm to ensure the overall area is more stable (fig. D).

**Step 7**

Cut the last plank in each row so that you leave a gap of at least 10mm or 1.5mm per metre to the wall. To cut the last row to size, use a spare piece of plank and draw the remaining plank width on it (leaving at least a gap of 10mm or 1.5mm per metre to the wall). After you have laid the last planks, you can walk on the floor straight away and start attaching the skirting boards.

**Step 8**

Finally, remove the wooden wedges from around the walls.

To cover the all-round expansion joints, use MEISTER skirting boards or clip-on skirting boards with colour-matching decorative surfaces (see page 28). Please avoid any silicon products coming into contact with the mouldings.

**To take a plank row back out again,** lift the entire row, levering it at the side out of the last row. Then you can separate the planks' ends by angling them. This way, the locking system remains intact and the planks can be refitted.

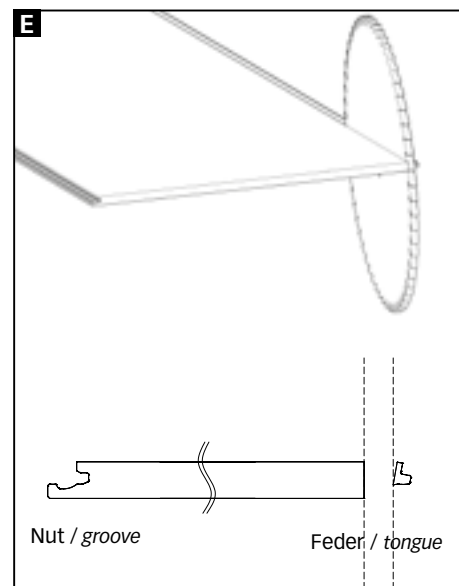
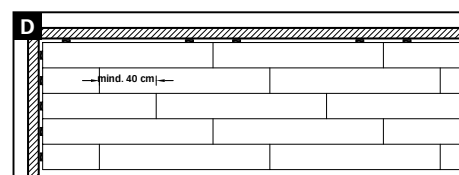
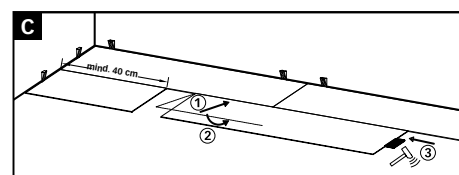
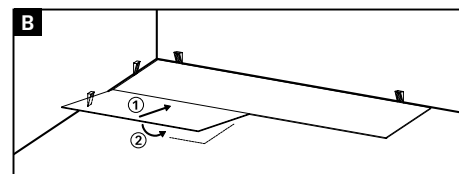
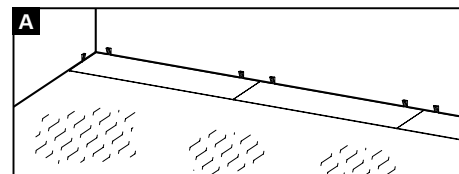

- ① Join the tongue on the long side
- ② Angle in
- ③ Join the ends

# MEISTER design flooring with Multiclic technology



**You need the following tools and aids to install MEISTER design flooring with Multiclic technology:**

Hammer, keyhole or electric saw, possibly power drill, folding metre rule, pencil, wedges (spacer wedges), tension rod, angle or adjustable bevel, **MEISTER 5mm tapping block**, possibly PE film (0.2mm).

If the product does not already feature a sound-absorbing cushioning, use MEISTER-Silence 15 DB, MEISTER-Silence 20 or MEISTER-Silence 25 DB as a cushioning layer. (When using MEISTER-Silence 25 DB or MEISTER-Silence 15 DB additional 0.2mm PE film is not required.)

**Any other cushioning layers must have a suitable pressure stability (CS-value  $\geq 60$  kPa) and be 1–3 mm thick.**

**Step 1**

Start by laying the first complete plank in the left-hand corner of the room with the tongue sides facing the wall. Saw the tongues off the first plank, both on the short and the long side (fig. F). Remove only the tongues on the long sides of all the other planks you want to lay in the first row. Using wedges, you can easily keep a gap of at least 10mm or 1.5mm per metre from the wall.

**Step 2**

Join the next complete plank to the end of plank 1 using the 5mm tapping block and a hammer. Install the other planks in this row in exactly the same way across the entire width of the room. Wherever space is too tight to work with a hammer and tapping block, you can use a tension rod to help click the end joint in place.

**Step 3**

Make sure the planks in the first row are straight (fig A). Cut the first plank of the second row down to approx. 80cm (with MeisterDesign. flex DB 400 approx. 50–60 centimetres). To install the second row, insert the long tongue into the groove of the first row of planks (fig. B, ①).

**Step 4**

By moving the plank slightly up and down, angle it completely into the already laid row of planks (fig. B, ②).

**Step 5**

Again, angle the next complete plank of the second row first on its long edge against the previously laid plank. Always make sure the long joint is tight. Once you have angled in the planks (fig. C ① and ②) so they lie flat on the subfloor, start by installing the first plank in the third row. As soon as you have angled in and laid this plank (fig. D ① and ②), click the second plank in the previous row together at the ends using the 5mm tapping block and light taps with the hammer (fig. D ③).

**Step 6**

Continue installing the panels row by row in this way. Install the planks row by row until you have covered the whole room – always first fitting the long tongue into the groove and then joining the plank ends together.

Before you click the plank together at the ends using the hammer and tapping block, a plank should already be angled into the next row (guide plank fig. D). Remember that the end joints must be offset by at least 40cm (with MeisterDesign. flex DB 400 approx. 25cm) to ensure the overall area is more stable (fig. E).

**Step 7**

Cut the last plank in each row so that you leave a gap of at least 10mm or 1.5mm per metre to the wall. To cut the last row to size, use a spare piece of plank and draw the remaining plank width on it (leaving at least a gap of 10mm or 1.5mm per metre to the wall). After you have laid the last planks, you can walk on the floor straight away and start attaching the skirting boards.

**Step 8**

Finally, remove the wooden wedges from around the walls. To cover the all-round expansion joints, use MEISTER skirting boards or clip-on skirting boards with colour-matching decorative surfaces (see page 28). Please avoid any silicon products coming into contact with the mouldings.

**To take a plank row back out again**, lift the entire row, levering it at the side out of the last row. Then you can separate the planks' ends by angling them. This way, the locking system remains intact and the planks can be refitted.

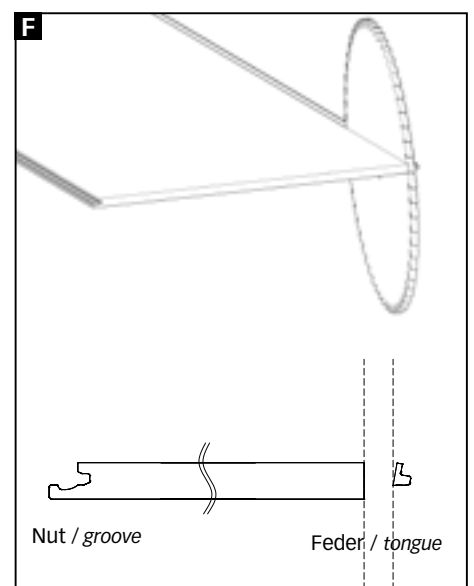
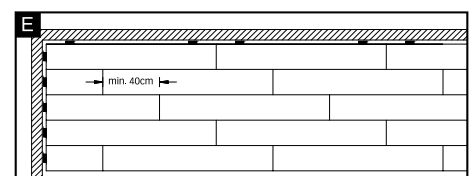
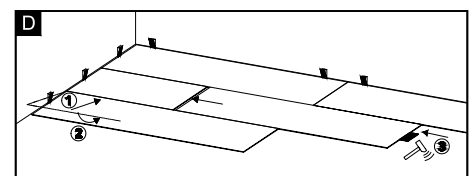
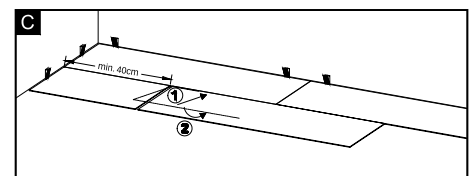
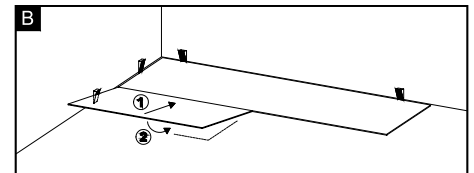
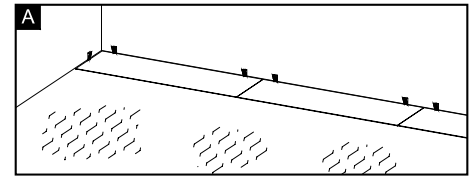

- ① Join the tongue on the long side
- ② Angle in
- ③ Join the ends

# Design flooring MeisterDesign. life with Maxiclic technology

**MAXICLIC**®

DE 102005012827

**You need the following tools and aids for installing MEISTER design flooring:** Rubber hammer with a white head (non-marking), installation knife with trapezoidal blade, jig saw or electric saw, folding metre rule, pencil, spacer wedges, angle or adjustable bevel.

**If the product does not already feature a Silence backing, you must use the system-oriented MEISTER insulating underlay SilenceGrip (CS value > 400 kPa) as a cushioning layer. Other types of insulating underlay must meet the increased requirements in accordance with the technical bulletin "TM 1" from MMFA for Class 2 floor coverings.**

The flooring is installed as a floating structure without glue. The specially designed click connection Maxiclic (fold-down system) allows quick and easy installation. The long edge of the plank is angled with the tongue side into the groove of the previous row (fig. A) and lowered into the previous plank at the end (fig. B). The Maxiclic connection at the end is then locked by blows with a white rubber hammer (fig. B). If the floor area is longer or wider than 15m, you must provide an expansion joint. Cover this with a transition profile. It is also important to provide these joints between two adjacent rooms, in doorways, passageways and many-angled rooms.

You can score the planks with an installation knife (trapezoidal blade) once or twice and then fold them down. Sawing with a jig saw or portable circular saw or snapping with a guillotine cutter are also possible. When sawing the elements, make sure you work from the correct side: if you use a bench saw, keep the decorative side facing up, if you use a keyhole or portable circular saw, keep the decorative side down.

**Install a mixture of planks from different packages to achieve a consistent design across the entire surface.**

## Step 1

Start by laying the first complete plank in the left-hand corner of the room with the tongue sides facing the wall. Remove the tongues only on the long sides of all the planks you want to lay in the first row (fig. 1). Using the wedges you can easily maintain a gap of at least 5mm to the wall (fig. 2).

## Step 2

Insert the next complete plank into the head end of plank 1 and lock them by blows with a white rubber hammer (fig. 3). Install the other planks in this row in exactly the same way across the entire width of the room.

## Step 3

Make sure that the planks in the first row are straight. Cut the first plank of the second row down to approx. 80cm (in the case of DB 800 to approx. 50-60 cm). Angle this plank with the tongue into the groove side of the previous row of planks and slowly press the plank down using a forwards and downwards twisting movement (fig. 4).

## Step 4

Again, angle the next complete plank of the second row first on its long edge against the previously laid plank and press it tight to the head end of the previous plank before lowering it. You then press the plank down using a forwards and downwards twisting movement (fig. 5). The head end is locked by blows with a white rubber hammer (fig. 6).

## Step 5

Continue installing the panels row by row in this way. Remember that the end joints must be offset by at least 30cm (fig. 7) (in the case of DB 800 approx. 20cm).

## Step 6

Cut the last plank in each row so that you leave a gap of at least 5mm to the wall. To cut the last row to size, use a spare piece of plank and draw the remaining plank width on it (leaving at least a 5mm gap to the wall). Start installing the last row in the right-hand corner of the room and angle the long side of the plank into the last-but-one row (fig. 8). The next plank is turned in on the long side as before and lowered at the head end into the previous plank. Locking at the head end is again through blows with the rubber hammer.

## Step 7

Finally, remove the spacer wedges from around the walls. To cover the all-round expansion joints, use MEISTER skirting boards with colour-matching decorative surfaces (see page 28). Please avoid any silicon products coming into contact with the mouldings.

**To take a plank row back out again,** lift the entire row, levering it at the side out of the last row (fig. 9). Afterwards you can slide the ends of the planks apart (fig. 10). This way, the locking system remains intact and the planks can be refitted.

**For installation in humid rooms (Class W1-I),** the wall ends and edge areas must be sealed, in the case of full-surface bonding with plasticiser-free silicone or natural stone silicone, for example. For floating installation, use the waterproof MEISTER skirting board 20 PK Aqua profile or an aluminium profile in combination with plasticiser-free, permanently elastic silicone or natural stone silicone (fig. C + D). In areas where no skirting boards or aluminium profiles can be used, a PE joint filling cord (plasticiser-free) must be used in combination with plasticiser-free, permanently elastic silicone or natural stone silicone (fig. E). **Permanently elastic sealed joints must be considered as maintenance joints and require permanent maintenance and care to avoid subsequent damage.**

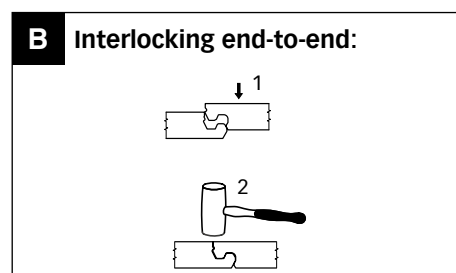
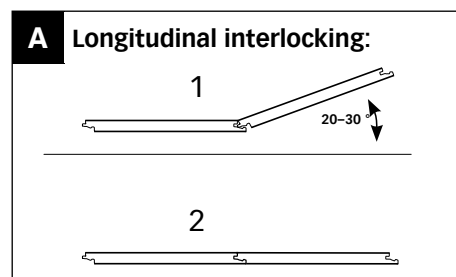



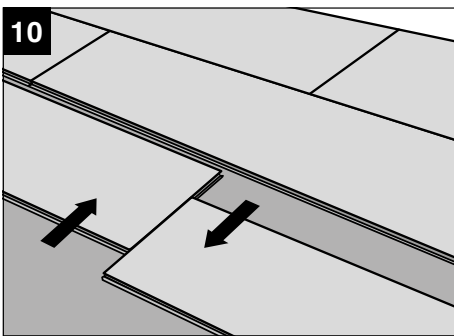
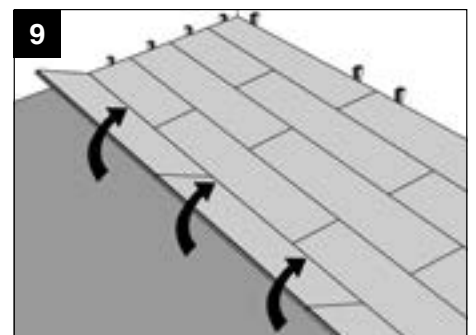
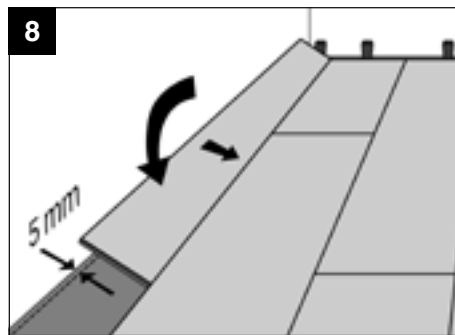
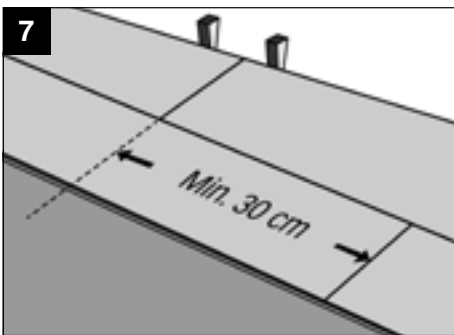
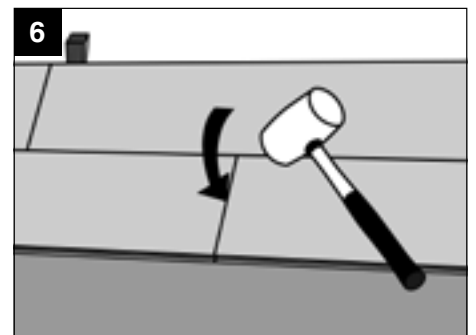
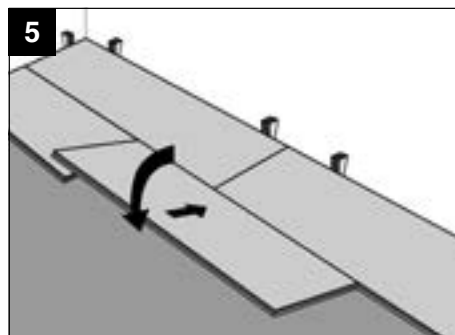
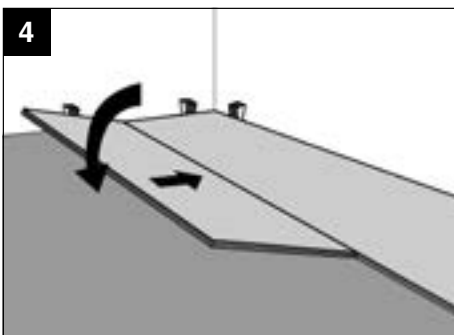
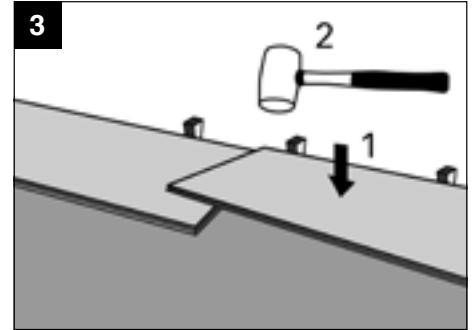
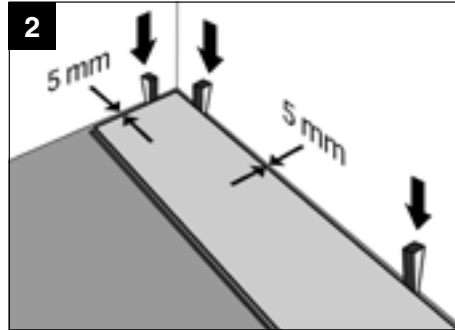
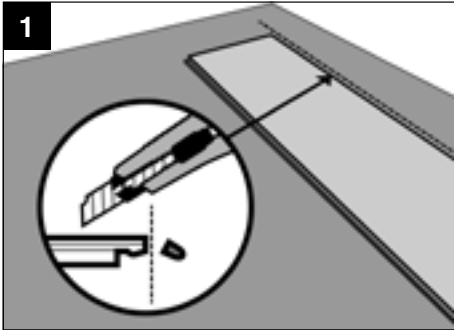

- A – Pre-compressed and plasticiser-free PE sealing tape
- B – Maintenance joint, permanently flexible, plasticiser-free silicone
- D – PE joint filler cord, plasticiser-free

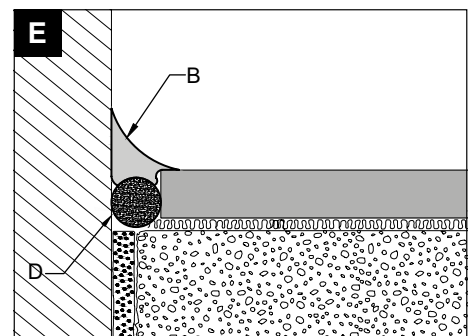
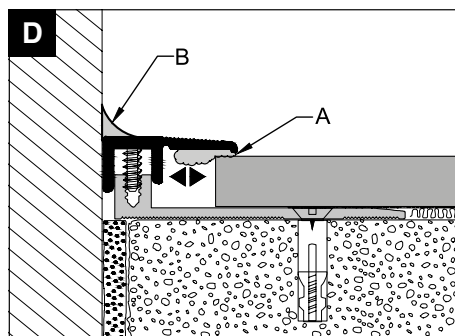
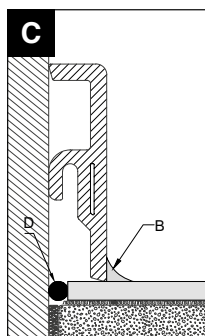

Attention: Please heed the up-to-date installation instructions included in the packaging.

# Laminate flooring Melango, Micala and Talamo in humid rooms

The laying instructions for Masterclac Plus (see page 18) and the general notes and preparatory measures must be observed.

**So-called "humid rooms" (Class W0-I) are all rooms with higher but not permanent moisture and/or with periodically high humidity e.g. bathrooms. This does not include outdoor areas and wet rooms, e.g. saunas, shower cubicles, steam rooms and rooms with a floor drain.**

All Premium laminate flooring from MEISTER is suitable for humid rooms as they have the AquaSafe system's comprehensive protection against humidity. **Please note: do not leave puddles of water/spills to dry on the surface but wipe up and wipe dry immediately (within 30 minutes).** This also applies to wet and damp objects, including textiles, bath mats etc.

In addition, any parts of the flooring which come into contact with sanitary cleaners, chemicals etc. must be wiped with clear water without delay.

Care must always be taken that no humidity gets under the flooring. For this reason, appropriate structural measures must be taken for floating installation in humid rooms. Edge joints are generally necessary to guarantee the flooring can expand, particularly in rooms with high humidity.

Wall ends and edge areas should preferably be fitted with suitable end, transition or joining profiles made of aluminium. To ensure the necessary seal against liquids, a pre-compressed PE sealing tape without plasticisers can be used, for example. This tape is glued under the cover profile. Once this has been screwed to the base profile, the result is a sealed finish with the flooring. The bottom profile must be glued to the adhesive and sealing tape of the respective sound-absorbing cushion.

Joints between the profile and the wall must be sealed water-impermeably using a permanently flexible sealing compound (plasticiser-free silicone). This also applies to the wall and edge areas where non of the above-mentioned aluminium profiles can be used. In such areas, a PE joint filler cord (plasticiser-free) must be used as to finish off. These expansion joints must also be sealed with sealing compound to prevent humidity penetration. Joints in the edge and wall area must always have a width of 10 mm to fixed building structures. This is a maintenance joint which, as a flexible joint, requires permanent maintenance and care. The term maintenance joint is used for all those joints which are exposed to heavy chemical and/or physical influences and whose sealants must be checked at regular intervals and renewed if necessary in order to avoid consequential damage.

## With end profile

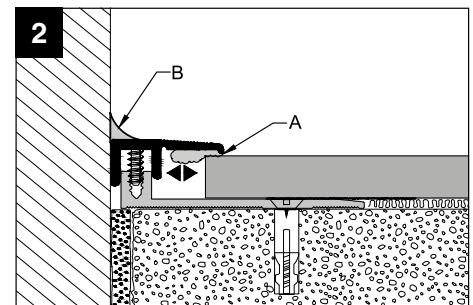
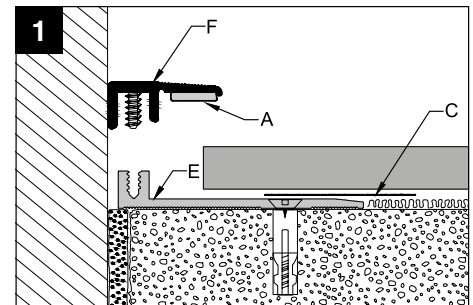

## Without end profile

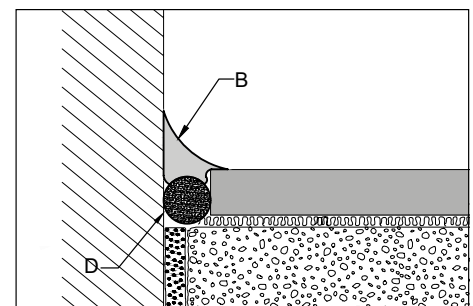

## With waterproof skirting board 20 PK profile

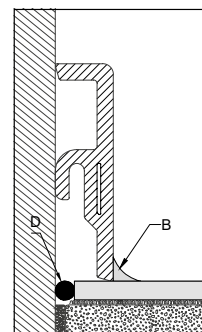

- A – Pre-compressed and plasticiser-free PE sealing tape
- B – Maintenance joint, permanently flexible, plasticiser-free silicone
- C – Adhesive tape for sound-absorbing cushion
- D – PE joint filler cord, plasticiser-free
- E – Bottom profile
- F – Cover profile



# Design flooring Catega® Flex, MeisterDesign. flex and MeisterDesign. comfort in humid rooms

The laying instructions for Masterclit Plus or Multiclic technology (see page 18 or 21) and the general notes and preparatory measures must be observed.

**So-called "humid rooms" (Class W0-I) are all rooms with higher but not permanent moisture and/or with periodically high humidity e.g. bathrooms. This does not include outdoor areas and wet rooms, e.g. saunas, shower cubicles, steam rooms and rooms with a floor drain.**

**Please note: do not leave puddles of water/spills to dry on the surface but wipe up and wipe dry immediately (within 4 hours).**

In addition, any parts of the flooring which come into contact with sanitary cleaners, chemicals etc. must be wiped with clear water without delay.

Care must always be taken that no humidity gets under the flooring. For this reason, appropriate structural measures must be taken for floating installation in humid rooms. Edge joints are generally necessary to guarantee the flooring can expand, particularly in rooms with high humidity.

Wall ends and edge areas should preferably be fitted with suitable end, transition or joining profiles made of aluminium. To ensure the necessary seal against liquids, a pre-compressed PE sealing tape without plasticisers can be used, for example. This tape is glued under the cover profile. Once this has been screwed to the base profile, the result is a sealed finish with the flooring. The bottom profile must be glued to the adhesive and sealing tape of the respective sound-absorbing cushion.

Joints between the profile and the wall must be sealed water-impermeably using a permanently flexible sealing compound (plasticiser-free silicone). This also applies to the wall and edge areas where non of the above-mentioned aluminium profiles can be used. In such areas, a PE joint filler cord (plasticiser-free) must be used as to finish off. These expansion joints must also be sealed with sealing compound to prevent humidity penetration. Joints in the edge and wall area must always have a width of 10 mm to fixed building structures. This is a maintenance joint which, as a flexible joint, requires permanent maintenance and care. The term maintenance joint is used for all those joints which are exposed to heavy chemical and/or physical influences and whose sealants must be checked at regular intervals and renewed if necessary in order to avoid consequential damage.

## With end profile

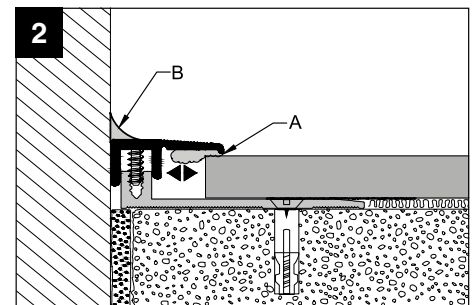
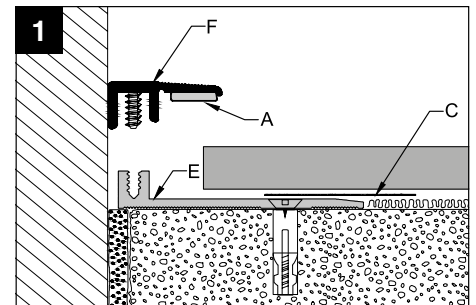

## Without end profile

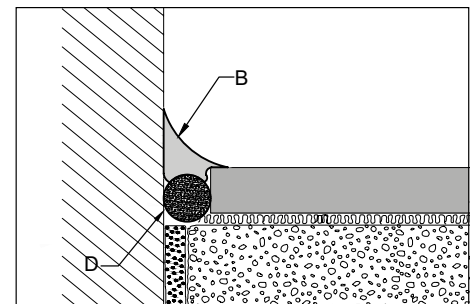

## With waterproof skirting board 20 PK profile

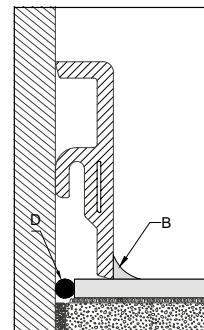

- A – Pre-compressed and plasticiser-free PE sealing tape
- B – Maintenance joint, permanently flexible, plasticiser-free silicone
- C – Adhesive tape for sound-absorbing cushion
- D – PE joint filler cord, plasticiser-free
- E – Bottom profile
- F – Cover profile

# Flooring profiles

If the floor area is longer or wider than 10m (for MeisterDesign. life longer or wider than 15 m), then you must provide an expansion joint. This is covered with a transition profile. Please also be aware of this in doorways, passageways and many-angled rooms.

In general, two adjacent rooms must be separated by a transition profile. Use the joining profile to adjust to adjacent, lower lying areas or floor coverings.

The clip-on end profile is ideal for clean transitions to adjacent, higher thresholds, tiles or the like. Stairs that are laid with MEISTER flooring have a clean finish with the stair edge profile.

**Joining, end and transition profiles, anodised aluminium, matching all MEISTER design flooring (except for: design flooring Catega® Flex DD 300 | DD 300 S, MeisterDesign. flex and MeisterDesign. life)**

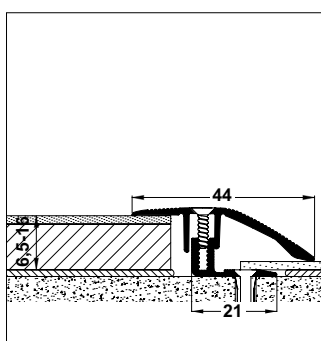

**Joining profile type 200 (6.5 to 16mm)**

Use the joining profile to adjust to adjacent, lower lying areas or floor coverings (e.g. carpet, linoleum etc.)

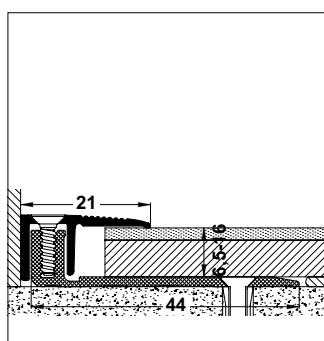

**End profile type 201 B (6.5 to 16mm)**

Broad bottom profile allows better fixing to substrate.

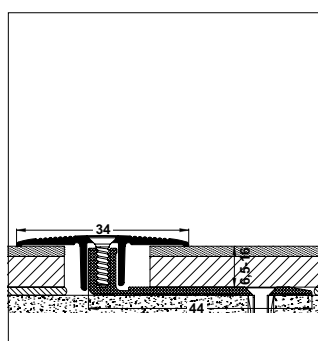

**Transition profile type 202 B (6.5 to 16mm)**

Broad bottom profile allows better fixing to substrate. For expansion joints: Height differences of up to 3mm can be overcome.

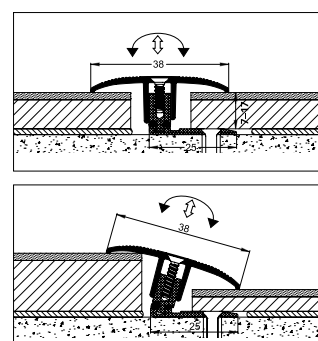

**Transition profile Flexo type 302 (7 to 17mm)**

For expansion joints: Suited for floor coverings between 7 and 17mm (at equal covering height).

Bridges height differences of up to 12mm (e.g. from 23mm to 8mm or from 15mm to 3mm).

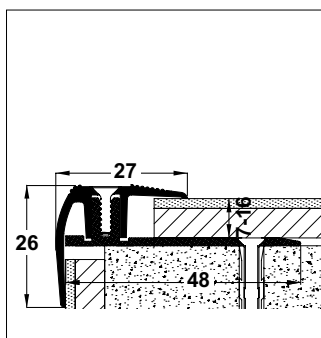

**Stair profile type 203 (7 to 16mm)**

Supplied as a 2-part profile system (cover and base element). Screws are provided.

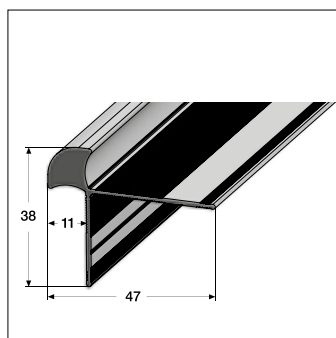

**Stair profile type 11 (10 to 11mm)**

Two-sided; discreet, visible edge; drilled countersunk, with grooves.

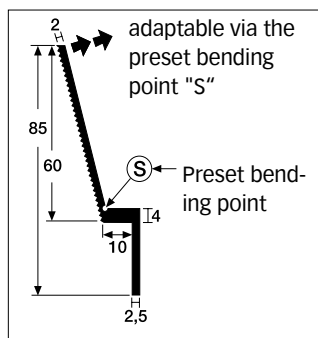

**Sloping angle 3402**

With adhesive grooves; natural-coloured aluminium; with countersunk drill holes; 20mm x 3.5mm Ø wood screws with cross-slot head are provided.

Toughness: approx. 75N/sq.mm<sup>2</sup>. Length: 100 cm

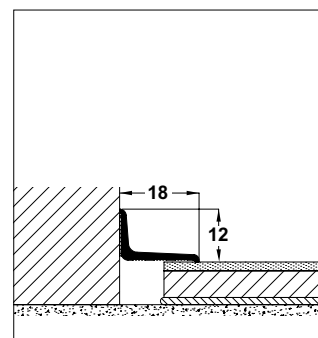

**End profile type 300 SK (self-adhesive)**

For clean finishes with patio doors and floor-to-ceiling windows.

**Clip-on transition profile "Flexo" and end profile with a specially coated laminate film or anodised aluminium, matching all MEISTER flooring (except for: design flooring Catega® Flex DD 300 | DD 300 S, MeisterDesign. flex and MeisterDesign. life)**

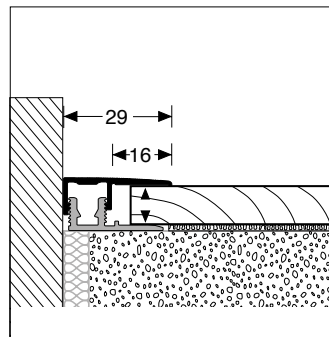
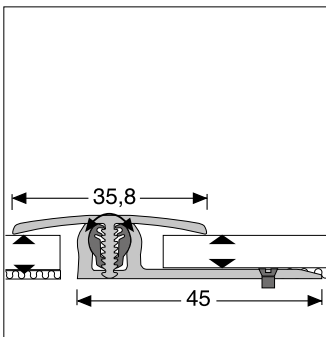

**Clip-on transition profile "Flexo" type 402 (7 to 15mm)**

Including 4-18mm height compensation.

For expansion joints: Bridges height differences of up to 6mm. Broad bottom profile enables a better fixation to the subfloor.

**Clip-on end profile type 401 (7 to 18mm)**

The clip-on end profile is ideal for clean transitions to adjacent, higher thresholds, tiles or the like.

**Joining, end and transition profiles, anodised aluminium, matching all MEISTER design flooring Catega® Flex DD 300 | DD 300 S, MeisterDesign. flex and MeisterDesign. life**

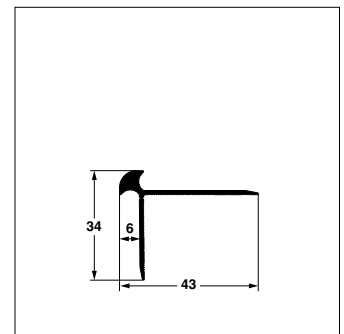
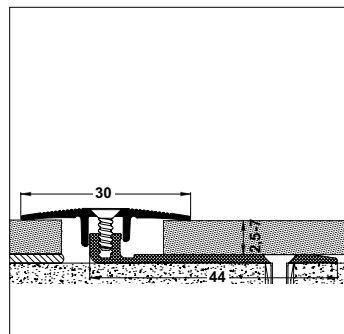
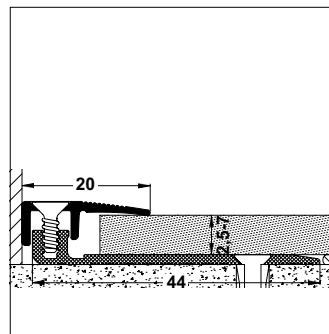
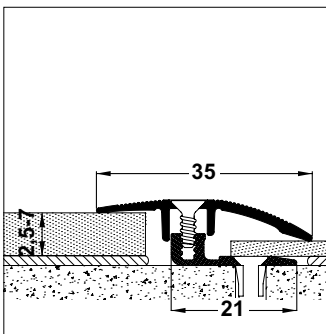

**Joining profile type 100 (2.5 to 7mm)**

Use the joining profile to adjust to adjacent, lower lying areas or floor coverings (e.g. carpet, linoleum etc.)

**End profile type 101 (2.5 to 7mm)**

The clip-on end profile is ideal for clean transitions to adjacent, higher thresholds, tiles or the like.

**Transition profile type 102 (2.5 to 7mm)**

For expansion joints. Bridges height differences of up to 3mm.

**Stair profile type 5 (5 to 6 mm)**

Two-sided; discreet, visible edge; drilled countersunk, with grooves.

# Wall transitions

To cover the expansion joints around the edges of MEISTER laminate flooring, use MEISTER clip-on skirting board profiles 1 to 3, for MEISTER Classic (LB 85) laminate flooring, we recommend MEISTER skirting board 8 PK profiles with matching decorative surface. For installation with MEISTER Longlife parquet and Lindura wood flooring, we offer matching real wood veneer MEISTER skirting board profiles 1 to 3.

To match MEISTER cork flooring, we also supply our cork-covered clip-on skirting board profiles 1 to 3. When installing MEISTER Nadura flooring, use MEISTER skirting board 8 PK profile. When installing MEISTER design flooring use the MEISTER skirting board 2 PK, 3 PK and 20 PK profiles with colour-matching decorative surface. The MEISTER skirting board profiles are a clean and sophisticated floor connector and can be fitted with a clip,

glued (with silicone-free assembly adhesive), nailed or screwed. A hollow space inside the attachment clips (PK) makes it possible to lay concealed cables through it. Please avoid any silicon products coming into contact with the mouldings.

## Skirting board – a perfect finish



Skirting board Profile 1 MK



Skirting board Profile 2 PK



Skirting board 3 PK profile



Skirting board 5 PK profile

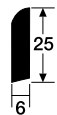

Skirting board Profile 6



Quarter round 7 profile

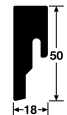

Skirting board 8 PK profile



Skirting board 9 PK profile



Skirting board 10 PK profile



Skirting board 11 PK profile

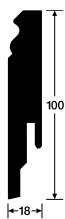

Skirting board 12 PK profile

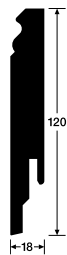

Skirting board 13 PK profile

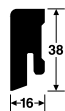

Skirting board 14 MK profile



Skirting board 15 MK profile



Skirting board 16 MK profile

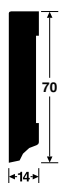

Skirting board 17 profile

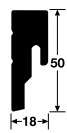

Skirting board 18 PK profile



Skirting board 19 PK profile



Skirting board 20 PK profile



Skirting board 20 PK Aqua profile

# Underlay materials

Thanks to the special PUR mineral blend, MEISTER-Silence 25 DB, MEISTER-Silence 20 or MEISTER-Silence 15 DB are the ideal insulating underlay for effective room and footfall noise protection. The high self-weight of the products also has a positive effect on the sound-absorbing properties. In the case of Silence 25 DB and 15 DB the vapour barrier is already integrated, which means the laying of an additional PE-film is no longer necessary on mineral subsurfaces.

The insulating underlay MEISTER-SilenceGrip is a 1.5 mm thick underlay made of a PUR mineral blend with non-slip effect and was especially developed for floor coverings with a solid, elastic and synthetic core with click system. The underlay fulfils the increased requirements of the technical bulletin issued by the MMFA (Multilayer Modular Flooring Association) for Class 2 floor coverings. All MEISTER underlay materials can be installed on underfloor heating. They comply

with the technical bulletin provided by the European Producers of Laminate Flooring (EPLF) based on CEN/TS 16354. The Silence products also meet the requirements of the technical bulletin issued by the Multi-layer Modular Flooring Association (MMFA) »Underlay Materials under Multilayer Modular Floor Coverings (MMF) – Test Standards and Performance Indicators« for Class 1 (with HDF-core).

## Product properties – underlay materials

Summary	Silence 25 DB	Silence 20	Silence 15 DB	SilenceGrip	Twin Control	Foam film	Plastic film
Material thickness approx.	3 mm	2.5 mm	2 mm	1.5 mm	2 mm	2 mm	0.2 mm
Weight approx.	3 kg/m <sup>2</sup>	2.3 kg/m <sup>2</sup>	1.5 kg/m <sup>2</sup>	1.5 kg/m <sup>2</sup>	0.3 kg/m <sup>2</sup>	0.2 kg/m <sup>2</sup>	
Pressure resistance	ca. 150 kPa ●●●●	ca. 170 kPa ●●●●	ca. 220 kPa ●●●●●	ca. 450 kPa ●●●●●	ca. 50 kPa ●●●	ca. 45 kPa ●●●	–
Room noise improvement	●●●●●	●●●●	●●●	●●●	●●	●●	–
Footfall noise improvement	●●●●	●●●●	●●●	●●●	●●●	●●●	–
Suitability for underfloor heating	●●●●	●●●●	●●●●	●●●●	●●	●●	●●●●●
Eignung für Fußbodenkühlung	●●●●	●●●●	●●●●	●●●●	–	–	●●●●●
Correction of unevenness	●●●●	●●●●	●●●	●●	●●●	●●●	–
Humidity protection	✓	No	✓	No	✓	No	✓

Summary	Silence 25 DB	Silence 20	Silence 15 DB	SilenceGrip	Twin Control	Foam film	Plastic film
Weight approx.	3 kg/m <sup>2</sup>	2.3 kg/m <sup>2</sup>	1.5 kg/m <sup>2</sup>	1.5 kg/m <sup>2</sup>	0.3 kg/m <sup>2</sup>	0.2 kg/m <sup>2</sup>	
Wooden planks	–	✗	–	✗	–	✗	–
Wood based boards, OSB boards, drywall elements	–	✗	–	✗	–	✗	–
Mineral subfloors (e.g. cement screed, anhydride screed)	✗	✗ with plastic film	✗	✗ with plastic film	✗	✗ with plastic film	✗
Mastic asphalt screed	–	✗	–	✗	–	✗	–
Existing coverings (e.g. ceramic tiles and boards, natural stone, plastic)	✗	✗ with plastic film	✗	✗ with plastic film	✗	✗ with plastic film	✗

Properties:

●●●●● Ideally suited ●●●● Very well suited ●●● Well suited ●● Suited • Suited to a certain extent ✓ Available ✗ Suited – Not suited

# MEISTER Longlife parquet flooring on warm-water heated floor structures

The entire MEISTER Longlife parquet range is suitable for installation on warmwater underfloor heating.

**Please follow the instructions below:**

The PD 450, PD 400, PD 200, PS 500, PS 300, PC 400 and PC 200 collections have a thermal resistance on MEISTER-Silence 25 DB of 0.118m<sup>2</sup> K/W. The MEISTER floors in the PS 400 collections have a thermal resistance of 0.13m<sup>2</sup> K/W when laid with MEISTER foam film (2mm) together with MEISTER PE film (0.2mm). Due to the natural warmth of the flooring, the heating can be switched off more often during moderately cold weather compared to heating under tiled floors. MEISTER flooring on underfloor heating reaches an even surface temperature all over. All types of wood are suitable for installation on hot-water underfloor heating – due to the natural swelling and shrinking properties of natural woods, open joints may appear. Especially maple and beech are more sensitive. The floors must not be covered with any coverings, e.g. carpets, runners, mats or any other overlays as this may cause an accumulation of heat. These types of flooring react with deformations and warping. When laying on hot water underfloor heating in commercial areas, we recommend the installation of a fidbox® (measuring device from floorprotector).

**Preparatory measures:**

Any room heated over a large area requires planning and coordination of the heating system, the screed and the various coverings, taking into account the type of use, in order to ensure optimum and fault-free functioning over the long term. When these special floor constructions are installed, professional standards are correspondingly important. Supplies and processing steps must correspond with the latest technology, the available information sheets from the central association of the German construction trade and the assembly and installation guidelines of the relevant system suppliers and manufacturers.

**Caution!** In case of underfloor heating, the bottom profiles of the transition profiles etc. are fixed with mounting adhesive.

**Screed – Checking moisture – Readiness for laying**

After completion and a corresponding lying time, the screed can be heated. Complete drying out (readiness for laying) is an absolute prerequisite for the preparation and installation steps for MEISTER Longlife parquet flooring and is therefore essential. The reason for this is that the moisture measurements to be carried out as part of subfloor checking cannot be reliably performed on heated constructions due to the risk of damage. This means that heated screed must be dried out by means of heating up and cooling down with a heating break before installation of any type of covering. To be ready for the installation of MEISTER flooring, the moisture content (according to DIN 4725, part 4 – measured with CM devices) of cement screed should be a maximum of 1.8 CM% and of anhydrite screed it should be a maximum of 0.3 CM%. The moisture content limits also apply to fast-hardening cement and screed with screed additives – TKB technical briefing note 14.

**Special measures**

(heating up and cooling down)  
The client must observe the following instructions and/or have them performed by the persons responsible:

- | The screed with underfloor heating must be heated up after its respective holding time in accordance with its specific data sheet.
- | During heating up, the initial temperature should be increased daily up to the full (maximum) heating power.
- | The pattern of the heating measure and the heating break must be carried out in accordance with the measure protocol.
- | The time plan indicates the minimum period of heating up – each additional day is of further benefit and provides extra security.
- | MEISTER Longlife parquet must be installed in accordance with DIN 18 356, 18 365 and 18 367 at a screed surface temperature of at least 15°C and a relative humidity of 30 - max. 65%.
- | After installation of the flooring (completion), this climate must be maintained for one week (adhering and hardening time of adhesives and other material layers used).
- | After installation of MEISTER Longlife parquet, the maximum surface temperature of 29°C may not be exceeded.

**Important note:** The above points must be carried out according to the relevant rules and/or confirmed by specialists (architect, heating specialist etc.)

**Structure of floating installation**

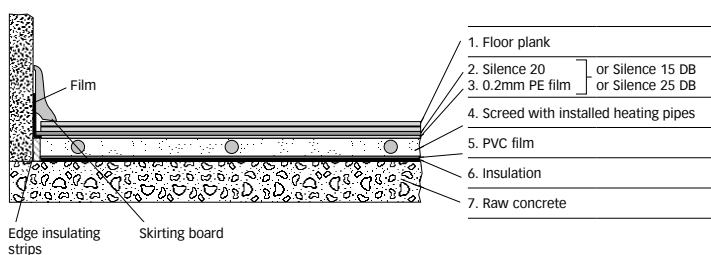

**Structure of surface bonding**

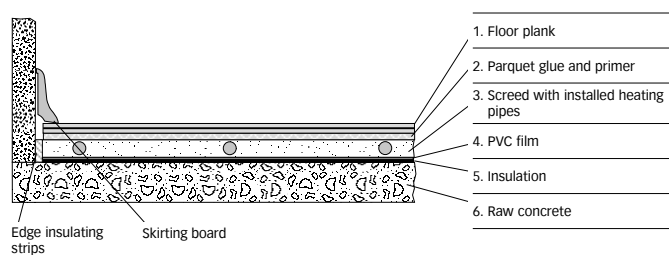

**Note:** Full surface bonding must be carried out by a professional.

# MEISTER Lindura wood flooring on warm water heated floor constructions

The MEISTER Lindura wood flooring is suitable for installation on hot-water underfloor heating.

**Please follow the instructions below:**

When installed with MEISTER-Silence 25 DB, MEISTER Lindura wood flooring has a thermal resistance of 0.084m<sup>2</sup> K/W.

Due to the natural warmth of the flooring, the heating can be switched off more often during moderately cold weather compared to heating under tiled floors. MEISTER flooring on underfloor heating reaches an even surface temperature all over. The floors must not be covered with any coverings, e.g. carpets, runners, mats or any other overlays as this may cause an accumulation of heat. These types of flooring react with deformations and warping. When laying on hot water underfloor heating in commercial areas, we recommend the installation of a fidbox® (measuring device from floorprotector).

**Preparatory measures:**

Any room heated over a large area requires planning and coordination of the heating system, the screed and the various coverings, taking into account the type of use, in order to ensure optimum and fault-free functioning over the long term. When these special floor constructions are installed, professional standards are correspondingly important. Supplies and processing steps must correspond with the latest technology, the available information sheets from the central association of the German construction trade and the assembly and installation guidelines of the relevant system suppliers and manufacturers.

**Caution!** In case of underfloor heating, the bottom profiles of the transition profiles etc. are fixed with mounting adhesive.

**Screed – Checking moisture – Readiness for laying**

After completion and a corresponding lying time, the screed can be heated. Complete drying out (readiness for laying) is an absolute prerequisite for the preparation and installation steps for MEISTER Lindura wood flooring is therefore essential. The reason for this is that the moisture measurements to be carried out as part of subfloor checking cannot be reliably performed on heated constructions due to the risk of damage.

This means that heated screed must be dried out by means of heating up and cooling down with a heating break before installation of any type of covering. To be ready for the installation of MEISTER flooring, the moisture content (according to DIN 4725, part 4 – measured with CM devices) of cement screed should be a maximum of 1.8 CM% and of anhydrite screed it should be a maximum of 0.3 CM%. The moisture content limits also apply to fast-hardening cement and screed with screed additives – TKB technical briefing note 14.

**Special measures**

(heating up and cooling down)

The client must observe the following instructions and/or have them performed by the persons responsible:

- | The screed with underfloor heating must be heated up after its respective holding time in accordance with its specific data sheet.
- | During heating up, the initial temperature should be increased daily up to the full (maximum) heating power.
- | The pattern of the heating measure and the heating break must be carried out in accordance with the measure protocol.
- | The time plan indicates the minimum period of heating up – each additional day is of further benefit and provides extra security.
- | MEISTER Lindura wood floorings must be installed in accordance with DIN 18 356, 18 365 and 18 367 at a screed surface temperature of at least 15°C and a relative humidity of 30 to max. 65%.
- | After installation of the flooring (completion), this climate must be maintained for one week (adhering and hardening time of adhesives and other material layers used).
- | After installation of MEISTER Lindura wood flooring, the maximum surface temperature of 29°C may not be exceeded.

**Important note:** The above points must be carried out according to the relevant rules and/or confirmed by specialists (architect, heating specialist etc.).

**Structure of floating installation**

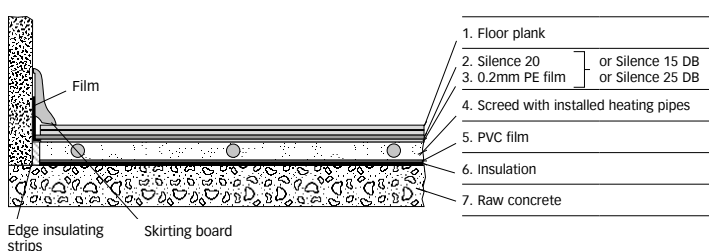

**Structure of surface bonding**

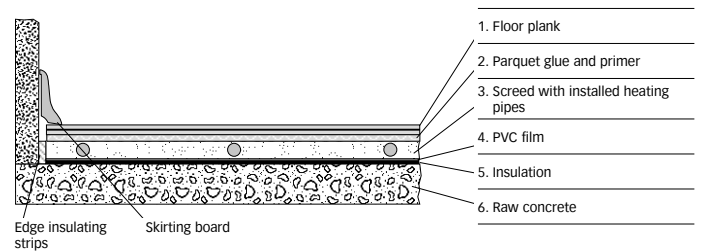

**Note:** Full surface bonding must be carried out by a professional.



# MEISTER cork flooring on warm water heated floor constructions

The MEISTER cork flooring is suitable for installation on hot-water underfloor heating.

### Please follow the instructions below:

When installed with 0.2mm PE film, MEISTER flooring from the Puro KD 300 S and Classic KC 85 S collections has a thermal resistance of 0.11m<sup>2</sup> K/W. Due to the natural warmth of the flooring, the heating can be switched off more often during moderately cold weather compared to heating under tiled floors. MEISTER flooring on underfloor heating reaches an even surface temperature all over.

The floors must not be covered with any coverings, e.g. carpets, runners, mats or any other overlays as this may cause an accumulation of heat. These types of flooring react with deformations and warping.

When laying on hot water underfloor heating in commercial areas, we recommend the installation of a fidbox® (measuring device from floorprotector).

### Preparatory measures:

Any room heated over a large area requires planning and coordination of the heating system, the screed and the various coverings, taking into account the type of use, in order to ensure optimum and fault-free functioning over the long term. When these special floor constructions are installed, professional standards are correspondingly important. Supplies and processing steps must correspond with the latest technology, the available information sheets from the central association of the German construction trade and the assembly and installation guidelines of the relevant system suppliers and manufacturers.

**Caution!** In case of underfloor heating, the bottom profiles of the transition profiles etc. are fixed with mounting adhesive.

### Screed – Checking moisture – Readiness for laying

After completion and a corresponding lying time, the screed can be heated. Complete drying out (readiness for laying) is an absolute prerequisite for the preparation and installation steps for MEISTER cork flooring and is therefore essential. The reason for this is that the moisture measurements to be carried out as part of subfloor checking cannot be reliably performed on heated constructions due to the risk of damage. This means that heated screed must be dried out by means of heating up and cooling down with a heating break before installation of any type of covering. To be ready for the installation of MEISTER flooring, the moisture content (according to DIN 4725, part 4 – measured with CM devices) of cement screed should be a maximum of 1.8 CM% and of anhydrite screed it should be a maximum of 0.3 CM%.

The moisture content limits also apply to fast-hardening cement and screed with screed additives – TKB technical briefing note 14.

### Special measures

(heating up and cooling down)

The client must observe the following instructions and/or have them performed by the persons responsible:

- | The screed with underfloor heating must be heated up after its respective holding time in accordance with its specific data sheet.
- | During heating up, the initial temperature should be increased daily up to the full (maximum) heating power.
- | The pattern of the heating measure and the heating break must be carried out in accordance with the measure protocol.
- | The time plan indicates the minimum period of heating up – each additional day is of further benefit and provides extra security.
- | MEISTER cork floorings must be installed in accordance with DIN 18 356, 18 365 and 18 367 at a screed surface temperature of at least 15°C and a relative humidity of 30 to max. 65%.
- | After installation of the flooring (completion), this climate must be maintained for one week (adhering and hardening time of adhesives and other material layers used).
- | After installation of MEISTER cork flooring, the maximum surface temperature of 29°C may not be exceeded.

**Important note:** The above points must be carried out according to the relevant rules and/or confirmed by specialists (architect, heating specialist etc.).

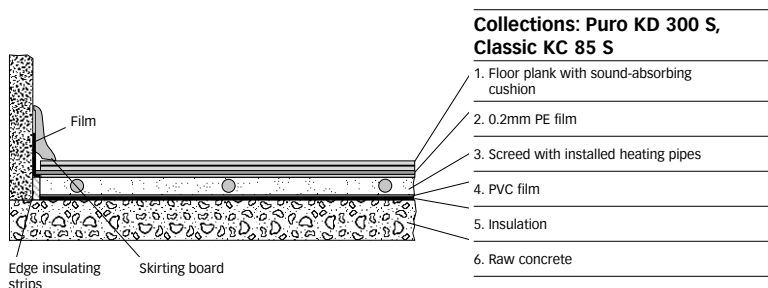



# MEISTER linoleum flooring on warm water heated floor constructions

The entire MEISTER linoleum flooring range is suitable for installation on hot water under-floor heating.

### Please follow the instructions below:

When installed with MEISTER PE film (0.2mm), MEISTER flooring from the Puro LID 300 S collection has a thermal resistance of 0.08m<sup>2</sup> K/W. Due to the natural warmth of the flooring, the heating can be switched off more often during moderately cold weather compared to heating under tiled floors. MEISTER flooring on underfloor heating reaches an even surface temperature all over.

The floors must not be covered with any coverings, e.g. carpets, runners, mats or any other overlays as this may cause an accumulation of heat. These types of flooring react with deformations and warping.

When laying on hot water underfloor heating in commercial areas, we recommend the installation of a fidbox® (measuring device from floorprotector).

### Preparatory measures:

Any room heated over a large area requires planning and coordination of the heating system, the screed and the various coverings, taking into account the type of use, in order to ensure optimum and fault-free functioning over the long term. When these special floor constructions are installed, professional standards are correspondingly important. Supplies and processing steps must correspond with the latest technology, the available information sheets from the central association of the German construction trade and the assembly and installation guidelines of the relevant system suppliers and manufacturers.

**Caution!** In case of underfloor heating, the bottom profiles of the transition profiles etc. are fixed with mounting adhesive.

### Screed – Checking moisture – Readiness for laying

After completion and a corresponding lying time, the screed can be heated. Complete drying out (readiness for laying) is an absolute prerequisite for the preparation and installation steps for MEISTER linoleum flooring and is therefore essential. The reason for this is that the moisture measurements to be carried out as part of subfloor checking cannot be reliably performed on heated constructions due to the risk of damage. This means that heated screed must be dried out by means of heating up and cooling down with a heating break before installation of any type of covering. To be ready for the installation of MEISTER flooring, the moisture content (according to DIN 4725, part 4 – measured with CM devices) of cement screed should be a maximum of 1.8 CM% and of anhydrite screed it should be a maximum of 0.3 CM%.

The moisture content limits also apply to fast-hardening cement and screed with screed additives – TKB technical briefing note 14.

### Special measures

(heating up and cooling down)

The client must observe the following instructions and/or have them performed by the persons responsible:

- | The screed with underfloor heating must be heated up after its respective holding time in accordance with its specific data sheet.
- | During heating up, the initial temperature should be increased daily up to the full (maximum) heating power.
- | The pattern of the heating measure and the heating break must be carried out in accordance with the measure protocol.
- | The time plan indicates the minimum period of heating up – each additional day is of further benefit and provides extra security.
- | MEISTER linoleum flooring must be installed in accordance with DIN 18 356, 18 365 and 18 367 at a screed surface temperature of at least 15°C and a relative humidity of 30 to max. 65%.
- | After installation of the flooring (completion), this climate must be maintained for one week (adhering and hardening time of adhesives and other material layers used).
- | After installation of MEISTER linoleum flooring, the maximum surface temperature of 29°C may not be exceeded.

**Important note:** The above points must be carried out according to the relevant rules and/or confirmed by specialists (architect, heating specialist etc.).

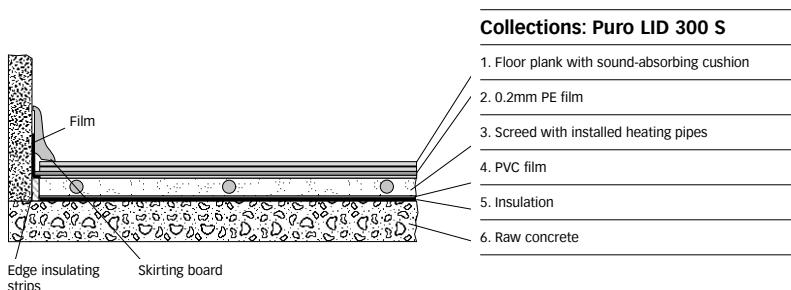

# MEISTER design flooring on warm water heated floor constructions

The MEISTER design flooring is suitable for installation on hot-water underfloor heating.

**Please follow the instructions below:**

When installed with MEISTER PE film (0.2mm), MEISTER flooring from the DD 350 S has a thermal resistance of 0.10m<sup>2</sup> K/W, the DS 600 S and the DD 600 S collections have a thermal resistance of 0.09m<sup>2</sup> K/W and the DD 300 S collection, a thermal resistance of 0.05m<sup>2</sup> K/W. The collections DD 300, DD 400 and DB 400 have a thermal resistance of 0.05 m<sup>2</sup> K/W when installed on MEISTER-Silence 15 DB. The collections DD 800 and DB 800 have a thermal resistance of 0.02 m<sup>2</sup> K/W when installed on Meister-SilenceGrip. Due to the natural warmth of the flooring, the heating can be switched off more often during moderately cold weather compared to heating under tiled floors. MEISTER flooring on underfloor heating reaches an even surface temperature all over.

The floors must not be covered with any coverings, e.g. carpets, runners, mats or any other overlays as this may cause an accumulation of heat. These types of flooring react with deformations and warping.

When laying on hot water underfloor heating in commercial areas, we recommend the installation of a fidbox® (measuring device from floorprotector).

**Preparatory measures:**

Any room heated over a large area requires planning and coordination of the heating system, the screed and the various coverings, taking into account the type of use, in order to ensure optimum and fault-free functioning over the long term.

When these special floor constructions are installed, professional standards are correspondingly important.

Supplies and processing steps must correspond with the latest technology, the available information sheets from the central associ-

ation of the German construction trade and the assembly and installation guidelines of the relevant system suppliers and manufacturers.

**Caution!** In case of underfloor heating, the bottom profiles of the transition profiles etc. are fixed with mounting adhesive.

**Screed – Checking moisture – Readiness for laying**

After completion and a corresponding lying time, the screed can be heated. Complete drying out (readiness for laying) is an absolute prerequisite for the preparation and installation steps for MEISTER design flooring and is therefore essential. The reason for this is that the moisture measurements to be carried out as part of subfloor checking cannot be reliably performed on heated constructions due to the risk of damage. This means that heated screed must be dried out by means of heating up and cooling down with a heating break before installation of any type of covering. To be ready for the installation of MEISTER flooring, the moisture content (according to DIN 4725, part 4 – measured with CM devices) of cement screed should be a maximum of 1.8 CM% and of anhydrite screed it should be a maximum of 0.3 CM%.

The moisture content limits also apply to fast-hardening cement and screed with screed additives – TKB technical briefing note 14.

**Special measures**

(heating up and cooling down)

The client must observe the following instructions and/or have them performed by the persons responsible:

- | The screed with underfloor heating must be heated up after its respective holding time in accordance with its specific data sheet.
- | During heating up, the initial temperature should be increased daily up to the full (maximum) heating power.
- | The pattern of the heating measure and the heating break must be carried out in accordance with the measure protocol.
- | The time plan indicates the minimum period of heating up – each additional day is of further benefit and provides extra security.
- | MEISTER design flooring must be installed in accordance with DIN 18 356, 18 365 and 18 367 at a screed surface temperature of at least 15°C and a relative humidity of 30 to max. 65%.
- | After installation of the flooring (completion), this climate must be maintained for one week (adhering and hardening time of adhesives and other material layers used).
- | After installation of MEISTER design flooring, the maximum surface temperature of 29°C may not be exceeded.

**Important note:** The above points must be carried out according to the relevant rules and/or confirmed by specialists (architect, heating specialist etc.).

Structure of floating installation

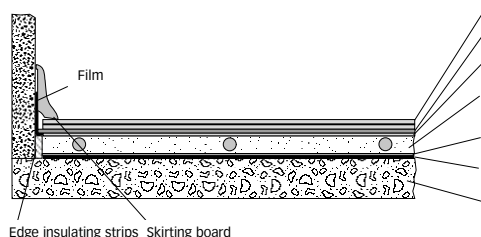

Collections: DD 300, DD 400, DB 400	DD 300 S, DD 350 S, DD 600 S, DB 600 S	DD 800, DB 800
1. Floor plank	Floor plank with sound-absorbing cushion	Floor plank
2. Silence 20 3. 0.2mm PE film	or Silence 15 DB or Silence 25 DB	0.2mm PE film
4. Screed with installed heating pipes	Screed with installed heating pipes	Screed with installed heating pipes
5. PVC film	PVC film	PVC film
6. Insulation	Insulation	Insulation
7. Raw concrete	Raw concrete	Raw concrete

# MEISTER Nadura flooring on warm water heated floor constructions

All MEISTER Nadura flooring is suitable for installation on hot-water underfloor heating.

**Please follow the instructions below:**

When installed with MEISTER-Silence 25 DB MEISTER flooring from the NB 400 collection has a heat transmission resistance of 0.10m<sup>2</sup> K/W. Due to the natural warmth of the flooring, the heating can be switched off more often during moderately cold weather compared to heating under tiled floors. MEISTER flooring on underfloor heating reaches an even surface temperature all over. The floors must not be covered with any coverings, e.g. carpets, runners, mats or any other overlays as this may cause an accumulation of heat. These types of flooring react with deformations and warping. When laying on hot water underfloor heating in commercial areas, we recommend the installation of a fidbox® (measuring device from floorprotector).

**Preparatory measures:**

Any room heated over a large area requires planning and coordination of the heating system, the screed and the various coverings, taking into account the type of use, in order to ensure optimum and fault-free functioning over the long term. When these special floor constructions are installed, professional standards are correspondingly important. Supplies and processing steps must correspond with the latest technology, the available information sheets from the central association of the German construction trade and the assembly and installation guidelines of the relevant system suppliers and manufacturers.

**Caution!** In case of underfloor heating, the bottom profiles of the transition profiles etc. are fixed with mounting adhesive.

**Screed – Checking moisture – Readiness for laying**

After completion and a corresponding lying time, the screed can be heated. Complete drying out (readiness for laying) is an absolute prerequisite for the preparation and installation steps for MEISTER Nadura flooring and is therefore essential. The reason for this is that the moisture measurements to be carried out as part of subfloor checking cannot be reliably performed on heated constructions due to the risk of damage. This means that heated screed must be dried out by means of heating up and cooling down with a heating break before installation of any type of covering. To be ready for the installation of MEISTER flooring, the moisture content (according to DIN 4725, part 4 – measured with CM devices) of cement screed should be a maximum of 1.8 CM% and of anhydrite screed it should be a maximum of 0.3 CM%.

The moisture content limits also apply to fast-hardening cement and screed with screed additives – TKB technical briefing note 14.

**Special measures**

(heating up and cooling down)

The client must observe the following instructions and/or have them performed by the persons responsible:

- | The screed with underfloor heating must be heated up after its respective holding time in accordance with its specific data sheet.
- | During heating up, the initial temperature should be increased daily up to the full (maximum) heating power.
- | The pattern of the heating measure and the heating break must be carried out in accordance with the measure protocol.
- | The time plan indicates the minimum period of heating up – each additional day is of further benefit and provides extra security.
- | MEISTER Nadura flooring must be installed in accordance with DIN 18 356, 18 365 and 18 367 at a screed surface temperature of at least 15°C and a relative humidity of 30 to max. 65%.
- | After installation of the flooring (completion), this climate must be maintained for one week (adhering and hardening time of adhesives and other material layers used).
- | After installation of MEISTER Nadura flooring, the maximum surface temperature of 29°C may not be exceeded.

**Important note:** The above points must be carried out according to the relevant rules and/or confirmed by specialists (architect, heating specialist etc.).

**Structure of floating installation**

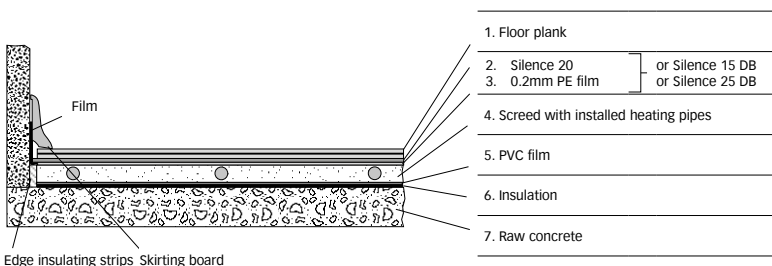

**Structure of surface bonding**

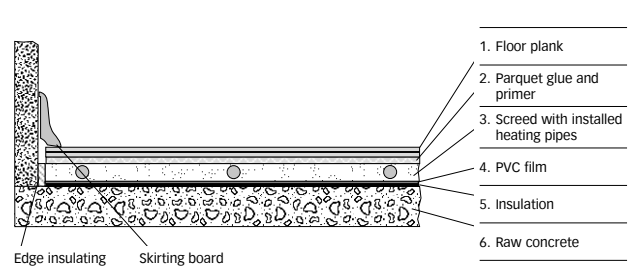

**Note:** Full surface bonding must be carried out by a professional.

# MEISTER laminate flooring on warm water heated floor constructions

All MEISTER laminate flooring is suitable for installation on hot-water underfloor heating.

### Preparatory measures:

Any room heated over a large area requires planning and coordination of the heating system, the screed and the various coverings, taking into account the type of use, in order to ensure optimum and fault-free functioning over the long term. When these special floor constructions are installed, professional standards are correspondingly important. Supplies and processing steps must correspond with the latest technology, the available information sheets from the central association of the German construction trade and the assembly and installation guidelines of the relevant system suppliers and manufacturers. The floors must not be covered with any coverings, e.g. carpets, runners, mats or any other overlays as this may cause an accumulation of heat. These types of flooring react with deformations and warping.

**Caution!** In case of underfloor heating, the bottom profiles of the transition profiles etc. are fixed with mounting adhesive.

### Screed – Checking moisture – Readiness for laying

After completion and a corresponding lying time, the screed can be heated. Complete drying out (readiness for laying) is an absolute prerequisite for the preparation and installation steps for MEISTER laminate flooring and is therefore essential. The reason for this is that the moisture measurements to be carried out as part of subfloor checking cannot be reliably performed on heated constructions due to the risk of damage. This means that heated screed must be dried out by means of heating up and cooling down with a heating break before installation of any type of covering. To be ready for the installation of MEISTER flooring, the moisture content (according to DIN 4725, part 4 – measured with CM devices) of cement screed should be a maximum of 1.8 CM% and of anhydrite screed it should be a maximum of 0.3 CM%.

The moisture content limits also apply to fast-hardening cement and screed with screed additives – TKB technical briefing note 14.

### Special measures

(heating up and cooling down)  
The client must observe the following instructions and/or have them performed by the persons responsible:

- | The screed with underfloor heating must be heated up after its respective holding time in accordance with its specific data sheet.
- | During heating up, the initial temperature should be increased daily up to the full (maximum) heating power.
- | The pattern of the heating measure and the heating break must be carried out in accordance with the measure protocol.
- | The time plan indicates the minimum period

of heating up – each additional day is of further benefit and provides extra security.

| MEISTER laminate floorings must be installed in accordance with DIN 18 356, 18 365 and 18 367 at a screed surface temperature of at least 15°C and a relative humidity of 30 to max. 65%.

| After installation of the flooring (completion), this climate must be maintained for one week (adhering and hardening time of adhesives and other material layers used).

| After installation of MEISTER laminate flooring, the maximum surface temperature of 29°C may not be exceeded.

**Important note:** The above points must be carried out according to the relevant rules and/or confirmed by specialists (architect, heating specialist etc.).

### Laminate flooring heat transmitting resistance MEISTER laminate flooring on insulating underlays

	Installation on MEISTER Twin Control m <sup>2</sup> K/W	Installation on MEISTER-Silence 25 DB m <sup>2</sup> K/W
Laminate flooring Melango	–	0.09
Laminate flooring Micala	0.115	0.07
Laminate flooring Talamo	0.115	0.07
Laminate flooring Classic		
LB 85	0.115	0.07
LD 95	0.115	0.07
LD 75	0.115	0.07
LC 75	0.115	0.07
LC 55	0.104	–

### Laminate flooring with integrated sound-absorbing lining

	Installation on MEISTER Twin Control m <sup>2</sup> K/W	Installation with 0.2 mm MEISTER-PE film m <sup>2</sup> K/W
Laminate flooring Melango	–	0.083
Laminate flooring Micala	–	0.075
Laminate flooring Talamo	–	0.075
Laminate flooring Classic		
LD 95 S	–	0.075
LD 75 S	–	0.075
LC 75 S	–	0.075
LC 55 S	–	0.069

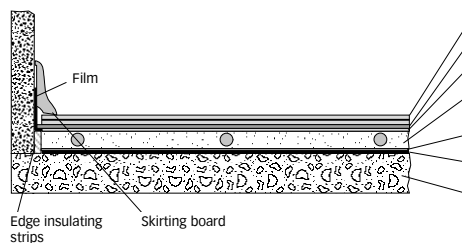

### Collections:

#### Laminate flooring Melango, Micala, Talamo, Classic

1. Floor plank
2. Foam film
3. 0.2mm PE film } or Twin Control or Silence 15 DB  
or Silence 25 DB
4. Screed with installed heating pipes
5. PVC film
6. Insulation
7. Raw concrete

#### Laminate flooring Melango, Micala, Talamo, Classic

- |  |
|--|
| Floor plank with sound-absorbing cushion |
| 0.2mm PE film                            |
| Screed with installed heating pipes      |
| PVC film                                 |
| Insulation                               |
| Raw concrete                             |

# Full surface bonding with MEISTER Longlife parquet, Lindura wood flooring and Nadura flooring

MEISTER Longlife parquet flooring, Lindura wood flooring and Nadura can also be installed with full surface bonding using an approved adhesive as an alternative to floating installation.

Please note that all installation instructions for Masterclac Plus connections, Quadroclic Plus connections and Uniclic connections must be followed carefully at all times as well as the general recommendations / Technical Commission on Construction Adhesives (TKB) technical briefing notes and preparatory measures explained in the installation instructions when installing flooring with full surface bonding.

MeisterWerke recommends a water-free, shear-resistant adhesive released by the adhesive manufacturer.

**If you require more information please contact the MeisterWerke or adhesive manufacturer's technical customer service.**

### Information on adhesives:

The recommendations for adhesives are based on extensive tests conducted by the manufacturers. Due to the variability of on-site conditions, it is not possible to establish warranty claims based on the information provided. We cannot assume liability for any losses incurred in using the adhesive system. For that reason, we recommend that you test the adhesive yourself thoroughly before installing flooring or contact the adhesive manufacturer's technical customer service.

### Installation method:

With the floors mentioned lay each plank individually in the fresh adhesive bed. Then press them down well so that the backs of the planks are moistened as thoroughly as possible. To avoid hollow spots, extra weight can also be applied to the planks using a suitable material. Please note all of the adhesive manufacturer's instructions such as those on hardening and working time.

According to DIN 18 365 and 18356, the subsurface for flooring or parquet must always be smooth, dry, clean, free of cracks and release agents, and able to withstand lifting and pressing force.

CM moisture content with screed:

Cement screed: 2.0 CM-% (with underfloor heating: 1.8 CM-%)

Anhydrite screed: 0.5 CM-% (with underfloor heating: 0.3 CM-%)

(The moisture content limits also apply to fast-hardening cement and screed with screed additives – TKB technical briefing note 14.)

The contractor responsible for laying the flooring/parquet must ensure that subsurface material is inspected for technical suitability. This inspection must be in accordance with the recognised rules of the trade and current technology, and in compliance with the German Construction Contract Procedures (Vergabe- und Vertragsordnung für Bauleistungen – VOB). If the subsurface reveals deficiencies or there is a risk of damage occurring to the construction of the flooring, the contractor must report these concerns in writing, particularly in the following cases:

- | Serious unevenness
- | Cracks in the subsurface
- | Insufficiently dry subsurface
- | Insufficiently firm surface
- | Contaminated subsurfaces, e.g. oil, wax, lacquer, paint residues
- | Subsurface not being level with adjoining structures
- | Unsuitable subsurface temperature
- | Unsuitable room climate
- | No documentation on heating characteristics for heated flooring constructions
- | Required secure locking of expansion joints in the subsurface
- | No edging strip projection
- | No marking of measurement points for heated flooring constructions
- | No joint layout (if necessary)

### Fidbox®

Humidity and fluctuations in temperature can influence how long a floor lasts and retains its value. We therefore recommend using a fidbox® (a measuring device from floorprotector), which can take long-term data recordings for temperature (°C) and relative humidity (%) in the immediate vicinity of the floor, which can be read using a reading device. If there should be a claim for damage, this can be clarified quickly using the results thus preventing any protracted research into the causes. You can obtain more information from MeisterWerke.

# Full surface bonding with Design flooring MeisterDesign. life

The design flooring MeisterDesign. life can also be installed with full surface bonding using an approved adhesive as an alternative to floating installation.

Please note that all installation instructions concerning the click connection must be followed carefully at all times as well as the general recommendations / Technical Commission on Construction Adhesives (TKB) technical briefing notes and preparatory measures explained in the installation instructions when installing flooring with full surface bonding. With regard to the required level of subsurface evenness, we recommend consulting technical information sheet no.02 from the Zentralverband für Parkett und Fußbodentechnik (Central Association for Parquet Flooring and Flooring Technology) and the BEB (Federal Association of Screed and Floor Covering)

MeisterWerke recommends a water- and solvent-free adhesive released by the adhesive manufacturer. The adhesive used should comply with the DIN ISO 17178 definitions of hard or hard elastic. Ask the respective adhesive manufacturer how the subfloor should be prepared for this particular system.

**If you require more information please contact the adhesive manufacturer's technical customer service.**

#### **Information on adhesives:**

The recommendations for adhesives are based on extensive tests conducted by the manufacturers. Due to the variability of on-site conditions, it is not possible to establish warranty claims based on the information provided. We cannot assume liability for any losses incurred in using the adhesive system. For that reason, we recommend that you test the adhesive yourself thoroughly before installing flooring or contact the adhesive manufacturer's technical customer service.

#### **Installation method:**

With the floors mentioned lay each plank individually in the fresh adhesive bed. Then press them down well so that the backs of the planks are moistened as thoroughly as possible. To avoid hollow spots, extra weight

can also be applied to the planks using a suitable material.

Please note all of the adhesive manufacturer's instructions such as those on hardening and working time.

According to DIN 18365 and 18356, the subsurface for flooring or parquet must always be smooth, dry, clean, free of cracks and release agents, and able to withstand lifting and pressing force.

CM moisture content with screed:

Cement screed: 2.0 CM-%

(with underfloor heating: 1.8 CM-%)

Anhydrite screed: 0.5 CM-%

(with underfloor heating: 0.3 CM-%)

The moisture content limits also apply to fast-hardening cement and screed with screed additives – TKB technical briefing note 14.

The contractor responsible for laying the flooring/parquet must ensure that subsurface material is inspected for technical suitability. This inspection must be in accordance with the recognised rules of the trade and current technology, and in compliance with the German Construction Contract Procedures (Vergabe- und Vertragsordnung für Bauleistungen – VOB). If the subsurface reveals deficiencies or there is a risk of damage occurring to the construction of the flooring, the contractor must report these concerns in writing, particularly in the following cases:

- | Serious unevenness
- | Cracks in the subsurface
- | Insufficiently dry subsurface
- | Insufficiently firm surface
- | Contaminated subsurfaces, e.g. oil, wax, lacquer, paint residues
- | Subsurface not being level with adjoining structures
- | Unsuitable subsurface temperature
- | Unsuitable room climate
- | No documentation on heating characteristics for heated flooring constructions
- | Required secure locking of expansion joints in the subsurface
- | No edging strip projection
- | No marking of measurement points for heated flooring constructions
- | No joint layout (if necessary)

# Full surface bonding with Design flooring MeisterDesign. pro

MeisterDesign. pro is a high-quality design flooring for full-surface bonding. Workmanship skills and product-specific knowledge is required for installation.

## General information:

Substrate preparation must be carried out in accordance with VOB DIN 18365. The relevant information sheets such as TKB information sheet no. 8 "Beurteilen und Vorbereiten von Untergründen für Bodenbelag- und Parkettarbeiten" (Evaluation and preparation of subfloors for flooring and parquet work) must be heeded. With regard to the required level of subsurface evenness, we recommend consulting technical information sheet no.02 from the Zentralverband für Parkett und Fußbodentechnik (Central Association for Parquet Flooring and Flooring Technology) and the BEB (Federal Association of Screed and Floor Covering).

MeisterWerke recommends a low-emission and solvent-free adhesive (RAL – Blue Angel or EC1), used with a system-oriented substrate preparation.

In order to achieve optimal wetting of the back and secure adherence, it is vital that you follow the instructions provided by the adhesive manufacturer regarding processing requirements, notched adhesive comb, application amounts and working times. Special approval from the adhesive manufacturer is required when using contact adhesive or reaction resin adhesive. After laying the covering in the adhesive bed, every plank must be pressed down with a scraping cork/handle scraper, and rolled with a heavy roller (min. 50 kg).

**If you need further information, please contact MeisterWerke's Technical Customer Services department or the adhesive manufacturer.**

## Information on adhesives:

The recommendations for adhesives are based on extensive tests conducted by the manufacturers. Due to the variability of on-site conditions, it is not possible to establish warranty claims based on the information provided. We cannot assume liability for any losses incurred in using the adhesive system. For that reason, we recommend that you test the adhesive

yourself thoroughly before installing flooring or contact the adhesive manufacturer's technical customer service.

According to DIN 18365 and 18356, the subsurface for flooring must always be smooth, dry, clean, free of cracks and release agents, and able to withstand lifting and pressing force.

CM moisture content with screed:

Cement screed: 2.0 CM-%

(with underfloor heating: 1.8 CM-%)

Anhydrite screed: 0.5 CM-%

(with underfloor heating: 0.3 CM-%)

The moisture content limits also apply to fast-hardening cement and screed with screed additives – TKB technical briefing note 14.

The contractor responsible for laying the flooring/parquet must ensure that subsurface material is inspected for technical suitability. This inspection must be in accordance with the recognised rules of the trade and current technology, and in compliance with the German Construction Contract Procedures (Vergabe- und Vertragsordnung für Bauleistungen – VOB). If the subsurface reveals deficiencies or there is a risk of damage occurring to the construction of the flooring, the contractor must report these concerns in writing, particularly in the following cases:

- | Serious unevenness
- | Cracks in the subsurface
- | Insufficiently dry subsurface
- | Insufficiently firm surface
- | Contaminated subsurfaces, e.g. oil, wax, lacquer, paint residues
- | Subsurface not being level with adjoining structures
- | Unsuitable subsurface temperature
- | Unsuitable room climate
- | No documentation on heating characteristics for heated flooring constructions
- | Required secure locking of expansion joints in the subsurface
- | No edging strip projection
- | No marking of measurement points for heated flooring constructions
- | No joint layout (if necessary)

# Care products

## Overview of the use of the care products

	Cleaning after completion of construction work/day-to-day cleaning	Freshening care	Special cleaning
<b>MEISTER-Longlife parquet and Lindura wood flooring</b>			
naturally oiled	Dr. Schutz Wood Care for Oiled Floors MR: 1:200 Article no. 9061 87 070 A22  In areas with heavy wear/ commercial areas: First cleaning Dr. Schutz Premium Care Oil for Wood Floors MR: undiluted Article no. 9061 87 080 A22	Dr. Schutz H <sub>2</sub> Oil MR: undiluted Article no. 9061 87 160 A22  In areas with heavy wear/ commercial areas: Dr. Schutz Premium Care Oil for Wood Floors MR: undiluted Article no. 9061 87 080 A22	Dr. Schutz Deep Clean for hard floors MR: 1:1 to 1:3 Article no. 9061 87 040 A22
lacquered   matt lacquered	Dr. Schutz Wood and Cork Floor Cleaner MR: 1:200 Article no. 9061 87 012 A22	Dr. Schutz Wood and Cork Floor Polish mat MR: undiluted Article no. 9061 87 031 A22	Dr. Schutz Deep Clean for hard floors MR: undiluted Article no. 9061 87 040 A22
high-gloss lacquered	Dr. Schutz Wood and Cork Floor Cleaner MR: 1:200 Article no. 9061 87 012 A22		Dr. Schutz Deep Clean for hard floors MR: undiluted Article no. 9061 87 040 A22

## MEISTER design flooring

	<ol style="list-style-type: none"> <li>Cleaning after completion of construction work: Dr. Schutz PU Cleaner MR: 1:10 Article no. 9061 87 150 A22</li> <li>Day-to-day cleaning: Dr. Schutz PU Cleaner MR: 1:200 Article no. 9061 87 150 A22</li> </ol>	Dr. Schutz Floor Mat MR: undiluted Article no. 9061 87 090 A22	Dr. Schutz Deep Clean for hard floors MR: undiluted Article no. 9061 87 040 A22
--	--	--	---

## MEISTER cork flooring

naturally oiled	Dr. Schutz Wood Care for Oiled Floors MR: 1:200 Article no. 9061 87 070 A22	Dr. Schutz H <sub>2</sub> Oil MR: undiluted Article no. 9061 87 160 A22	Dr. Schutz Deep Clean for hard floors MR: 1:1 to 1:3 Article no. 9061 87 040 A22
lacquered   matt lacquered	Dr. Schutz Wood and Cork Floor Cleaner MR: 1:200 Article no. 9061 87 012 A22	Dr. Schutz Wood and Cork Floor Polish mat MR: undiluted Article no. 9061 87 031 A22	Dr. Schutz Deep Clean for hard floors MR: 1:1 to 1:3 Article no. 9061 87 040 A22

## MEISTER linoleum flooring

	<ol style="list-style-type: none"> <li>Cleaning after completion of construction work: Dr. Schutz PU Cleaner MR: 1:10 Article no. 9061 87 150 A22</li> <li>Day-to-day cleaning: Dr. Schutz PU Cleaner MR: 1:200 Article no. 9061 87 150 A22</li> </ol>	Dr. Schutz Floor Mat MR: undiluted Article no.: 9061 87 090 A22	Dr. Schutz Deep Clean for hard floors MR: undiluted Article no. 9061 87 040 A22
--	--	---	---

## MEISTER Nadura flooring

	Dr. Schutz Laminate Cleaner MV: 1:200 Article no. 9061 87 001 A22		Dr. Schutz Deep Clean for hard floors MR: undiluted Article no. 9061 87 040 A22
--	---	--	---

## MEISTER laminate flooring

	Dr. Schutz Laminate Cleaner MR: 1:200 Article no. 9061 87 001 A22		Dr. Schutz Elatex Stain Remover MR: undiluted Article no. 9061 87 110 A22
--	---	--	---

MR = mixing ratio



# Cleaning and protective care agents

## **The quality does not stop with the installation.**

You have bought a quality product "made in Germany". These cleaning and care instructions will provide you with all the information important to ensuring a long period of value preservation and a beautiful appearance of your flooring. With a bit of time and effort, you can contribute to ensuring that you are able to enjoy your new MEISTER flooring for a long time to come.

MEISTER products are based on selected materials, which are processed by experienced experts with state-of-the-art technology to create a quality product "made in Germany". The premium quality includes substantiated consultation and excellent service. For this reason, you will only find MEISTER products in selected specialist shops.

## **1. The right care**

Your dream floor also needs the right care. MEISTER complements its product range with a high-quality series of care products from Dr. Schutz. Cleaners and care products, tailored for the floorings, ensure that your floor looks good in the long term. Even if you only need to run the vacuum round for day-to-day care (to remove loose dust), the surfaces should be cleaned and cared for regularly with Dr. Schutz care products to preserve the value of your floor.

When cleaning, please be aware that the floor must only ever be slightly moistened. In the ideal case, the film of water should be a thin mist, so that it dries out after about a minute. Some types of wood, such as beech or maple, are particularly sensitive to moisture. You should not use any abrasive cleaners, even in case of more severe stains. Even for stubborn stains and dirt, the Dr. Schutz Elatex Stain Remover\* will help.

Scratches on the floor not only affect the overall appearance. They will also make the floor more prone to dirt and moisture. The Dr. Schutz care products are designed to ensure that the floor is considerably more resistant to signs of wear and tear in heavy wear areas. Your qualified specialist shops will also be able to provide you with more tips on how to care for your MEISTER floor in the best possible way.

## **2. Preservation of value | precautionary measures**

A room temperature of approx. 18–22°C and a relative air humidity of approx. 30–65 percent will contribute to your personal well-being and are the basis for a healthy room climate. With such a room climate, you will also help your MEISTER floor obtain the optimal conditions, as it reacts to its climatic surroundings like any other wooden material. Low air humidity with a high temperature will lead to a contracting process in the wood, which dries the floor out. If you determine an air humidity which is considerably lower than 30 percent in the long term, we recommend the use of air humidifiers (vaporizers). This will prevent your MEISTER floor drying out excessively. As with all wooden products, very high air humidity will cause absorption of humidity, which can lead to the length and thickness increasing.

### **The introduction of dirt onto the floor:**

Most dirt is brought into your home from the outside and transferred onto the flooring. For this reason, we recommend installing a sufficiently large entrance covering (e.g. a doormat) in the entrance. Do not use any rubber-coated mats since prolonged contact can lead to permanent discoloration. Please consider that dirt, such as sand or small stones, will act like sandpaper on all floorings and can lead to unsightly scratches. To protect the wood from scratches, you should also fit chair and furniture feet with felt sliders; office chairs, mobile containers, etc., on castors must be equipped with soft, standard running surfaces (type w). Coloured rubber, natural rubber or plastic glides and castors as well as dark car, bike or equipment tyres may possibly cause discoloration on design flooring. Please only use light, non-migrating furniture glides, castors or tyres, if possible. We recommend protecting the floor in these heavy wear areas with appropriate floor protection mats (e.g. polycarbonate mats).

# Cleaning and protective care agents

### 3. Cleaning after completion of construction work

Newly laid MEISTER floors must be cleaned after completion of construction work and before first use in order to completely remove any dirt or glue residue which has arisen during the course of the installation.

You should clean **MEISTER laminate flooring** after completion of construction work with Dr. Schutz Laminate Cleaner\*, diluted with water in a ratio of 1:200.

You should clean **MEISTER Nadura flooring** after completion of construction work with Dr. Schutz Laminate Cleaner\*, diluted with water in a ratio of 1:200.

The cleaning after completion of construction work of **lacquered, matt lacquered and high gloss lacquered MEISTER Longlife parquet and Lindura wood flooring** should be carried out with Dr. Schutz Wood and Cork Floor Cleaner\*, diluted with water in a ratio of 1:200.

The cleaning after completion of construction work on **naturally oiled MEISTER Longlife parquet and MEISTER Lindura wood flooring** should be carried out with Dr. Schutz Wood Care for Oiled Floors\*, diluted with water in a ratio of 1:200. The flooring has been treated ready for residential use. To achieve further surface protection (so-called sacrificial layer), you can then apply undiluted H<sub>2</sub>Oil in a thin and even layer to the flooring using a lint-free mop. Treatment with Dr. Schutz Premium Care Oil in accordance with manufacturer's instructions will result in even better and longer-lasting surface protection. For **commercial areas and areas which are particularly highly frequented** (such as e.g. hallways, kitchens, dining rooms, open living areas with direct exit), subsequent treatment with Dr. Schutz Premium Care Oil is necessary. Apply the care oil in accordance with the manufacturer's instructions. After drying (at least 12 hours), the floor can be used again and can be cleaned using a thin mist of water again after allowing it to completely harden for 7 days.

The cleaning after completion of construction work on **lacquered and matt lacquered MEISTER cork flooring** should be carried out with Dr. Schutz Wood and Cork Floor Cleaner\*, diluted with water in a ratio of 1:200.

The cleaning after completion of construction work on **naturally oiled MEISTER cork flooring** should be carried out with Dr. Schutz Wood Care for Oiled Floors\*, diluted with water in a ratio of 1:200.

You should clean **MEISTER linoleum flooring after completion of construction work** with Dr. Schutz PU Cleaner\*, diluted with water in a ratio of 1:10.

Clean the floor using a well wrung out mop and then neutralise with clear water.

You should clean **MEISTER design flooring** and MEISTER design flooring after completion of construction work with Dr. Schutz PU Cleaner\*, diluted with water in a ratio of 1:10. Clean the floor using a well wrung out mop and then neutralise with clear water.

The floor is washed with a **mist** of water using the relevant cleaning solution and a non-lint mop.

*\* Water-based care products (e.g. polymer dispersions) or Dr. Schutz Elatex Stain Remover can penetrate the seams of the planks in the case of improper adhesion or incomplete jointing, leading to swelling of the base material.*

# Cleaning and protective care agents

## 4. Day-to-day cleaning

### MEISTER laminate flooring

To remove daily dirt, vacuuming or sweeping is sufficient. For conventional mopping, Dr. Schutz Laminate Cleaner\*, diluted with water in a ratio of 1:200, can be used. The floor should be wiped with a thin mist of water using a non-lint cloth, which has been dipped in this solution and wrung out well. Remove stains, smears and other bonded dirt with Dr. Schutz Elatex Stain Remover\* or undiluted Dr. Schutz Laminate Cleaner\* and a non-scratch, white pad. Then, wipe with a thin mist of water, until the dirt and cleaning agent residue is completely removed.

### MEISTER Nadura flooring

To remove daily dirt, vacuuming or sweeping is sufficient. For conventional mopping, Dr. Schutz Laminate Cleaner\*, diluted with water in a ratio of 1:200, can be used. The floor should be wiped with a thin mist of water using a non-lint cloth, which has been dipped in this solution and wrung out well. If necessary, use a scrubbing brush.

To remove stubborn stains dilute the Wood Floor Deep Clean with water in a ratio of 1:1 to 1:3 and spray the floor (using a hand spray or similar). Leave it to take effect for 5 minutes maximum, depending on the stubbornness of the stains. Then scrub the floor using a scrubbing brush. Remove the loosened dirt using a well pressed cloth and neutralise the floor using clean, if possible warm water until any residue dirt or cleaning products have been completely removed.

Remove stains and heel marks with Dr. Schutz Elatex Stain Remover\* (universal stain remover) or undiluted Dr. Schutz Laminate Cleaner\* or Dr. Schutz Wood Floor Deep Clean\* and a non-scratch, white pad. Then, wipe with a thin mist of water, until the dirt and cleaning agent residue is completely removed.

In **commercial** properties cleaning should always be possible using a cleaning machine or spray cleaning process with a disk buffing machine. For this, dilute Dr. Schutz Wood Floor Deep Clean\* with water in a ratio of 1:1. Please contact our technical customer services in case of application.

### Lacquered and matt lacquered MEISTER Longlife parquet and Lindura wood flooring

To remove daily dirt, vacuuming or sweeping is sufficient. Depending on the frequency and level of dirt, dilute Dr. Schutz Wood and Cork Floor Cleaner\* with water in a ratio of 1:200. The floor should be wiped with a thin mist of water using a non-lint cloth, which has been dipped in this solution and wrung out well. Remove fatty stains and other bonded dirt with undiluted Dr. Schutz Wood and Cork Floor Cleaner\* and a non-scratch, white pad. Then, wipe with a thin mist of water, until the dirt and cleaning agent residue is completely removed. Problem stains can be removed with Dr. Schutz Wood Floor Deep Clean. We recommend refreshing the floor with Dr. Schutz Wood and Cork Floor Polish mat to preserve its quality and at the first sign of wear. In areas subject to heavier levels of dirt or to build up resistance to wear, first carry out a deep clean using Dr. Schutz Wood Floor Deep Clean non-diluted with a green pad. After the floor has dried completely, apply Dr. Schutz Wood and Cork Floor Polish mat\* undiluted very thinly and evenly with a non-lint mop. Leave the floor to dry for at least 12 hours before use.

With the afore-mentioned deep clean use the Dr. Schutz Wood Floor Deep Clean\* non-diluted. Distribute the cleaning solution over the floor in sections using a cloth and then immediately remove any residue of the care product by scrubbing. Make sure that no puddles form. For larger surfaces, use a disk buffing machine with a green pad. Immediately absorb any dirty water completely with absorbent, dry cloths. Then wipe with a thin mist of clean water using a cloth. If possible carry out the cleaning in pairs so that one person removes the dirt and the other person immediately absorbs any dirty water.

### Note: High-gloss lacquered MEISTER Longlife parquet

At first signs of wear, refreshing the floor with corresponding care products is possible. These products however influence the high-gloss look of the parquet floor.

### Naturally oiled MEISTER Longlife parquet flooring and naturally oiled MEISTER Lindura wood flooring

To remove daily dirt, vacuuming or sweeping is sufficient. For regular cleaning and care use Dr. Schutz Wood Care for Oiled Floors\* diluted with water in a ratio of 1:200. The floor should be wiped with a thin mist of water using a non-lint cloth, which has been dipped in this solution and wrung out well. The floor is cleaned and polished in one work step. We recommend refreshing the floor with Dr. Schutz H<sub>2</sub>Oil\* to preserve its quality and at the first sign of wear. With normal levels of dirt clean the floor first using Dr. Schutz Wood Care for Oiled Floors diluted with water in a ratio of 1:200 and a green pad. After the floor has dried completely, apply Dr. Schutz H<sub>2</sub>Oil\* undiluted very thinly and evenly with a non-lint mop. Leave the floor to dry for at least 12 hours before use.

In cases of heavy soiling or care product build-up, carry out intensive cleaning first using Dr. Schutz intensive cleaner\* diluted to the ratio 1:1 to 1:3 with water and a green pad. Distribute the cleaning solution over the floor in sections using a cloth and then immediately remove any residue of the care product by scrubbing. Make sure that no puddles form. For larger surfaces, use a disk buffing machine with a green pad.

Immediately absorb any dirty water completely with absorbent, dry cloths. Then wipe with a thin mist of clean water using a cloth. If possible carry out the cleaning in pairs so that one person removes the dirt and the other person immediately absorbs any dirty water. **Subsequently, the flooring must always be re-oiled using Dr. Schutz Premium Care Oil in accordance with the manufacturer's instructions.**

After drying (at least 12 hours), the floor can be used again and can be cleaned using a thin mist of water again after allowing it to completely harden for 7 days.

# Cleaning and protective care agents

## **Where naturally oiled MEISTER Longlife parquet and naturally oiled Lindura wooden flooring are laid in areas subject to heavier wear or commercial areas,**

we always recommend refreshing/re-oiling the entire surface with Dr. Schutz Premium Care Oil in accordance with manufacturer's instructions if e.g. the surface becomes unsightly (extreme dirt, greying etc.). First, the floor must be cleaned thoroughly with Dr. Schutz Wood Floor Deep Clean (diluted with water at a ratio of 1:1 to 1:3). After drying (at least 12 hours), the floor can be used again and can be cleaned using a thin mist of water again after allowing it to completely harden for 7 days.

Osmo products can be used to clean and care for naturally oiled MEISTER Longlife parquet flooring and Lindura wood flooring.

For regular cleaning and care, we recommend Osmo Wisch-Fix, diluted with water. The floor should be washed with a thin mist of water using a non-lint mop. Then wipe dry. With regular use, the surface becomes resistant to new occurrences of dirt and signs of wear-and-tear.

To remove particularly stubborn stains and for occasional, intensive refreshing or maintenance, we recommend Osmo Wax Care and Cleaning Agent. First, the floor must be cleaned thoroughly with Osmo-Wisch-Fix. Immediately absorb any dirty water completely with an absorbent, dry mop. Apply Osmo Wax Care and Cleaning Agent thinly and evenly with a non-lint cloth. For larger surfaces, use a disk buffing machine with a white pad. Remove any surplus immediately with a dry cloth. After drying, the surface can be polished if required.

For heavier signs of wear-and-tear and for renovations, the floor should be treated afterwards with Osmo Hard Wax Oil 3062 matt.

## **Lacquered and matt lacquered MEISTER cork flooring**

Daily maintenance cleaning should be dry if possible (e.g. vacuuming/sweeping). Depending on the frequency and level of dirt, dilute Dr. Schutz Wood and Cork Floor Cleaner\* with water in a ratio of 1:200. The floor should be wiped with a thin mist of water using a non-lint cloth, which has been dipped in this solution and wrung out well. Remove fatty stains and other bonded dirt with undiluted Dr. Schutz Wood and Cork Floor Cleaner\* and a non-scratch, white pad. Then, wipe with a thin mist of water, until the dirt and cleaning agent residue is completely removed. In areas subject to heavier levels of dirt, add Dr. Schutz Wood and Cork Floor Polish mat\* for intensive care and apply undiluted, thinly and evenly with a lint-free mop onto the thoroughly cleaned floor (with Dr. Schutz Wood Floor Deep Clean\* for Wood and Cork Flooring undiluted).

## **MEISTER linoleum flooring**

Loose dust and dirt is removed by vacuuming or sweeping.

Depending on the frequency and degree of dirt, the removal of bonded dirt should be carried out with Dr. Schutz PU Cleaner\*, which is diluted with water at a ratio of 1:200. The floor should be wiped with a thin mist of water using a mop, which has been dipped in this solution and wrung out well. Remove stubborn stains and heel marks with undiluted Dr. Schutz PU Cleaner\* and a cloth or non-scratch, white pad. Then wipe the floor with clear water. A thorough clean of the floor is required to remove particularly stubborn dirt and residues and to prepare the floor for treatment with a care product in case of visible signs of wear. For this evenly spray Dr. Schutz Deep Clean\* undiluted on the floor and after allowing it to take effect for a short while (max. 5 minutes) scrub with a green pad or scrubbing brush. Wipe away loosened dirt using a cloth and wipe over again using clear water until all dirt and cleaner residue has been completely removed.

**Note:** If the flooring is not to receive a care treatment afterwards only use scrubbing brushes instead of green pads.

If there are signs of wear on the surface after long or intensive use, this can be refreshed with intensive maintenance after thoroughly cleaning the floor with (Dr. Schutz Deep Clean)\*. To do this, apply Dr. Schutz Floor Mat\* undiluted, thinly and evenly in a lengthwise direction with a lint-free mop rinsed in clear water and wrung out well. When the protective film can be walked on (after 45 minutes), apply a second coating in the crossways direction. Use: 750ml for approx. 25–35m<sup>2</sup> per application. If the protective film is worn away over the course of time, this can be refreshed with intensive maintenance after thoroughly cleaning the floor with Dr. Schutz Deep Clean\*.

# Cleaning and protective care agents

## MEISTER design flooring

Loose dust and dirt is removed by vacuuming or sweeping.

Depending on the frequency and degree of dirt, the removal of bonded dirt should be carried out with Dr. Schutz PU Cleaner\*, which is diluted with water at a ratio of 1:200. The floor should be wiped with a thin mist of water using a mop, which has been dipped in this solution and wrung out well. Remove stubborn stains and heel marks with undiluted Dr. Schutz PU Cleaner\* and a cloth or non-scratch, white pad. Then wipe the floor with clear water. A thorough clean of the floor is required to remove particularly stubborn dirt and residues and to prepare the floor for treatment with a care product in case of visible signs of wear. For this evenly spray Dr. Schutz Deep Clean\*

undiluted on the floor and after allowing it to take effect for a short while (max. 5 minutes) scrub with a green pad or scrubbing brush. Wipe away loosened dirt using a cloth and wipe over again using clear water until all dirt and cleaner residue has been completely removed.

**Note:** If the flooring is not to receive a care treatment afterwards only use scrubbing brushes instead of green pads.

If there are signs of wear on the surface after long or intensive use, this can be refreshed with intensive maintenance after thoroughly cleaning the floor with (Dr. Schutz Deep Clean)\*. To do this, apply Dr. Schutz Floor Mat\* undiluted, thinly and evenly in a lengthwise direction with a lint-free mop rinsed in clear water and wrung out well.

When the protective film can be walked on (after 45 minutes), apply a second coating in the crossways direction. Use: 750ml for approx. 25–35m<sup>2</sup> per application.

If the protective film is worn away over the course of time, this can be refreshed with intensive maintenance after thoroughly cleaning the floor with Dr. Schutz Deep Clean\*.

In commercial properties cleaning should always be possible using a cleaning machine or spray cleaning process with a disk buffing machine as well as separate value conservation measures. Please contact our technical customer services in case of application.

## 5. General information about cleaning and care

Never leave MEISTER flooring moist or wet over a long period of time. When cleaning, always try to use a dry method if possible (using a mop, hair broom, vacuum cleaner), or only wipe with a thin mist of water (with wrung out cloths) and do not leave any “puddles” on the floor. Steam cleaners are not suitable for the flooring. Do not use any cream cleaners or scouring powders as these agents can attack the surface of the floor.

Please only use suitable cleaners. Problem stains on laminate and Nadura floors as well as lacquered parquet and veneer flooring can be removed with Dr. Schutz Elatex Stain Remover (universal stain remover). Please be aware that you may increase the gloss level on the laminate/ Nadura surface by removing the stain with increased pressure with a white pad. For this reason, try this out in an inconspicuous place or left-over plank first.

*\* Water-based care products (e.g. polymer dispersions) or Dr. Schutz Elatex Stain Remover can penetrate the seams of the planks in the case of improper adhesion or incomplete jointing, leading to swelling of the base material.*

# Longlife warranty on MeisterWerke parquet

**I. Warranty cover:** MeisterWerke Schulte GmbH, Johannes-Schulte-Allee 5, 59602 Rùthen-Meiste, provides a warranty, over and beyond statutory rights under § 437 of the German Civil Code (replacement, cancellation of contract, reduction of purchase price and compensation), under the following warranty conditions. With the triple-layer parquet coating (fine wood wear layer, middle layer and backing) the parquet's special durability is achieved by using a special middle layer made from high density fibre board (HDF). Provided the product is properly used as intended in living areas, MeisterWerke warrants the durability of the three-layer glued structure of the product. The warranty does not cover any damage caused by incorrect treatment and use. In particular, any load or wear on the flooring that is not the purpose for which the flooring was intended, mechanical damage caused by furniture, pets etc. such as dents and scratches, for example. Optical faults such as joints, colour changes due to the effects of light or seasonal, climatic warping of individual planks are also not covered. Also excluded is damage due to an infestation of insects, incorrect care, cleaning or maintenance of the surface and the surface coating, especially chemical damage and/or damage due to the effects of moisture. The warranty applies exclusively to first choice products and use in private living areas subject to normal wear, with the exception of humid rooms, such as bathrooms or saunas. Special warranty conditions apply for the USA and Canada; this warranty does not apply in said regions.

**II. Warranty period:** The warranty period for MEISTER parquet flooring is 35 years after the appropriate date of purchase.

**III. Warranty conditions:** The flooring must have been fitted in accordance with the installation instructions enclosed in every third product package, in the permitted

areas of use named within the instructions. In particular the instructions relating to checking moisture in the substrate and the instructions for installation over underfloor heating must be observed. The floor must also be maintained and cleaned according to the care instructions enclosed with the product. If these installation and care instructions are missing and/or incomplete, the claimant must request these instructions from a specialist retailer or directly from MeisterWerke before starting the fitting. It should also be noted that the surface coating is a protective coating for the wear layer of wood underneath and is subject to normal wear. Therefore the warranty does not cover wearing down of this coating. When signs of wear appear, a specialist company must be engaged to expertly renew the surface in good time and to the extent necessary. Therefore the warranty does not cover damage resulting from incorrect installation, incorrect care or cleaning or a failure to expertly renew the surface coating in good time.

**IV. Reporting a warranty claim:** Any complaint must be made in text form (e.g. as a letter sent via the postal system, a fax, or an e-mail), enclosing a copy of the original invoice from the specialist retailer, which serves as a certificate of warranty. If it is not possible to present the original retailer's invoice, any claim under the warranty is excluded. Following receipt of the claim, MeisterWerke must notify the customer within four weeks of whether a warranty claim has been acknowledged. If no notification is given within this period, the warranty claim is deemed to have been rejected. During this period, MeisterWerke or a third party employed by them must be granted access to the product that is the subject of the complaint on site in order to investigate whether the claim is justified.

**V. Scope of the warranty:** When a warranty claim is acknowledged, MeisterWerke will at their discretion repair the faulty floor element or alternatively provide replacement material of the same quality, if at all possible from the same range, for the entire room in which the problem has occurred. The customer can collect the replacement material free of charge from the original sales outlet stated in the original invoice, excluding any further claims over and beyond this, including but not limited to compensation claims for the removal or fitting of the flooring or for consequential damage that has occurred other than in the product supplied itself.

**VI. Limitation of warranty:** The warranty period is not extended by a warranty claim. Claims under the warranty expire six months from the date of MeisterWerke's receipt of the customer's written complaint (see IV.), but no earlier than the expiry of the warranty period.

**VII. Choice of law:** This warranty is subject to German law, to the exclusion of the United Nations Treaty governing contracts for the international sale of goods. However, this does not affect the legal provisions regarding the limitation of the choice of law; in particular and in accordance with Art. 6 (2) of EC Regulation (EC) No. 593/2008 (the "Rome I Regulation"), the beneficiary of the warranty can, irrespective of the choice of law and in accordance with Section 1, invoke the mandatory protection of the law that would apply in the absence of this choice of law.

# Warranty on MeisterWerke Lindura wood flooring

---

**I. Warranty cover:** MeisterWerke Schulte GmbH, Johannes-Schulte-Allee 5, 59602 Rütten-Meiste, provides a warranty, over and beyond statutory rights under § 437 of the German Civil Code (replacement, cancellation of contract, reduction of purchase price and compensation), under the following warranty conditions. MeisterWerke warrants the durability of the multilayer product structure relating to pressing and fusing the single layers with one another. The warranty does not cover any damage caused by incorrect treatment and use. In particular, any load or wear on the flooring that is not the purpose for which the flooring was intended, mechanical damage caused by furniture, pets etc. such as dents and scratches, for example. Visual damage such as joints, changes in colour due to exposure to light and the deformation of individual planks caused by seasonal, room climate conditions are also not covered. Damage as a result of insect infestation, improper care, cleaning or maintenance of the surface and surface coating, specifically chemical damage or damage caused by the penetration of moisture is also not included. The warranty applies exclusively to first choice products and use in private living areas subject to normal wear up to heavy-wear areas, with the exception of humid rooms, such as bathrooms or saunas, or use in commercial areas with normal wear, e.g. offices, waiting rooms, boutiques etc. (corresponds to the range of application of wear class 32). Special warranty conditions apply for the USA and Canada; this warranty does not apply in said regions.

**II. Warranty period:** The warranty period is in accordance with the warranty time stated for each individual product and for the concrete type of use described, after the appropriate date of purchase respectively.

**III. Warranty conditions:** The flooring must have been fitted in accordance with the installation instructions enclosed in every third product package, in the permitted areas of use named within the instructions. In particular, information in the installation instructions about checking the humidity of subsurfaces and the installation on underfloor heating must be observed. The floor must also be maintained and cleaned according to the care instructions enclosed with the product. If these installation or care instructions are missing and/or incomplete, the claimant is obliged to request this information from their specialist retailer or directly from MeisterWerke before fitting the flooring. In addition, it should be noted that the surface coating is a protective layer for the wooden wear layer underneath it and is subject to normal wear. The wear of this surface coating is therefore not covered by the warranty. If signs of wear appear, the surface must be renewed in good time, properly to the required extent by a specialist company. The warranty therefore does not extend to damage that results from improper installation, cleaning or care, as well as the delayed improper repair of the surface coating.

**IV. Reporting a warranty claim:** Any complaint must be made in text form (e.g. as a letter sent via the postal system, a fax, or an e-mail), enclosing a copy of the original invoice from the specialist retailer, which serves as a certificate of warranty. If it is not possible to present the original retailer's invoice, any claim under the warranty is excluded. Once the claim is received by MeisterWerke, it must notify the customer within four weeks whether a warranty claim has been acknowledged. If no notification is given within this period, the warranty claim is deemed to have been rejected. During this period, MeisterWerke or a third party employed by them must be granted

access to the product that is the subject of the complaint on site in order to investigate the claim.

**V. Scope of the warranty:** When a warranty claim is acknowledged, MeisterWerke will at their discretion repair the faulty floor element or alternatively provide replacement material of the same quality, if at all possible from the same range, for the entire room in which the problem has occurred. The customer can collect the replacement material free of charge from the original sales outlet stated in the original invoice, excluding any further claims over and beyond this, including but not limited to compensation claims for the removal or fitting of the flooring or for consequential damage that has occurred other than in the product supplied itself.

**VI. Limitation of warranty:** The warranty period is not extended by a warranty claim. Claims under the warranty expire six months from the date of MeisterWerke's receipt of the customer's written complaint (see IV.), but no earlier than the expiry of the warranty period.

**VII. Choice of law:** This warranty is subject to German law, to the exclusion of the United Nations Treaty governing contracts for the international sale of goods. However, this does not affect the legal provisions regarding the limitation of the choice of law; in particular and in accordance with Art. 6 (2) of EC Regulation (EC) No. 593/2008 (the "Rome I Regulation"), the beneficiary of the warranty can, irrespective of the choice of law and in accordance with Section 1, invoke the mandatory protection of the law that would apply in the absence of this choice of law.

# Warranty on MeisterWerke cork and linoleum flooring

**I. Warranty cover:** MeisterWerke Schulte GmbH, Johannes-Schulte-Allee 5, 59602 Rütten-Meiste, provides a warranty, over and beyond statutory rights under § 437 of the German Civil Code (replacement, cancellation of contract, reduction of purchase price and compensation) under the following warranty conditions. Provided the product is properly used as intended in living areas, MeisterWerke warrants the durability of the three-layer glued structure of the product. The warranty does not cover any damage caused by incorrect treatment and use. In particular, any load or wear on the flooring that is not the purpose for which the flooring was intended, mechanical damage caused by furniture, pets etc. such as dents and scratches, for example. Optical faults such as joints, colour changes due to the effects of light or seasonal, climatic warping of individual planks are also not covered. Also excluded is damage due to an infestation of insects, incorrect care, cleaning or maintenance of the surface and the surface coating, especially chemical damage and/or damage due to the effects of moisture. The warranty applies exclusively to first choice products and use in private living areas subject to normal wear, with the exception of humid rooms, such as bathrooms or saunas. Special warranty conditions apply for the USA and Canada. This warranty does not apply in said regions.

**II. Warranty period:** The warranty period is in accordance with the warranty time stated for each individual product and for the concrete type of use described, after the appropriate date of purchase respectively.

**III. Warranty conditions:** The flooring must have been fitted in accordance with the installation instructions enclosed in every third product package, in the permitted areas of use named within the instructions. In particular the instructions relating to checking moisture in the substrate and the instructions for installation over underfloor

heating must be observed. The floor must also be maintained and cleaned according to the care instructions enclosed with the product. If these installation and care instructions are missing and/or incomplete, the claimant must request these instructions from a specialist retailer or directly from MeisterWerke before starting the fitting. It should also be noted that the surface coating is a protective coating for the wear layer of cork or linoleum underneath and is subject to normal wear. Therefore the warranty does not cover wearing down of this coating. When signs of wear appear, a specialist company must be engaged to expertly renew the surface in good time and to the extent necessary. Therefore the warranty does not cover damage resulting from incorrect installation, incorrect care or cleaning or a failure to expertly renew the surface coating in good time.

**IV. Reporting a warranty claim:** Any complaint must be made in text form (e.g. as a letter sent via the postal system, a fax, or an e-mail), enclosing a copy of the original invoice from the specialist retailer, which serves as a certificate of warranty. If it is not possible to present the original retailer's invoice, any claim under the warranty is excluded. Following receipt of the claim, MeisterWerke must notify the customer within four weeks of whether a warranty claim has been acknowledged. If no notification is given within this period, the warranty claim is deemed to have been rejected. During this period, MeisterWerke or a third party employed by them must be granted access to the product that is the subject of the complaint on site in order to investigate whether the claim is justified.

**V. Scope of the warranty:** When a warranty claim is acknowledged, MeisterWerke will at their discretion repair the faulty floor element or alternatively provide replacement material of the same quality, if at all possible from the same range, for the entire room in which the problem has occurred. The customer

can collect the replacement material free of charge from the original sales outlet stated in the original invoice, excluding any further claims over and beyond this, including but not limited to compensation claims for the removal or fitting of the flooring or for consequential damage that has occurred other than in the product supplied itself.

**VI. Limitation of warranty:** The warranty period is not extended by a warranty claim. Claims under the warranty expire six months from the date of MeisterWerke's receipt of the customer's written complaint (see IV.), but no earlier than the expiry of the warranty period.

**VII. Choice of law:** This warranty is subject to German law, to the exclusion of the United Nations Treaty governing contracts for the international sale of goods. However, this does not affect the legal provisions regarding the limitation of the choice of law; in particular and in accordance with Art. 6 (2) of EC Regulation (EC) No. 593/2008 (the "Rome I Regulation"), the beneficiary of the warranty can, irrespective of the choice of law and in accordance with Section 1, invoke the mandatory protection of the law that would apply in the absence of this choice of law.



# Warranty of wear resistance for MeisterWerke design, Nadura and laminate flooring

**I. Warranty cover:** MeisterWerke Schulte GmbH, Johannes-Schulte-Allee 5, 59602 Rütten-Meiste, provides a warranty, over and beyond statutory rights under § 437 of the German Civil Code (replacement, cancellation of contract, reduction of purchase price and compensation) that the decorative/veneer layer on the purchased product will not wear away within the warranty period provided the product is used properly for the purpose intended, according to the following warranty conditions. Any spot on which the decorative/veneer layer has been removed down to the substrate material over an area of at least 1cm<sup>2</sup> is regarded as having worn away, though signs of wear on the edge area of an individual floor element are excluded from this warranty. Any improper use of the floor for a purpose for which it is not intended, as well as mechanical damage and non-compliance with the MeisterWerke care instructions for the respective floor exclude this warranty.

The warranty applies exclusively to first choice products and use in private living areas or commercial areas depending on the wear class specified, with the exception of humid rooms, such as bathrooms or saunas. The warranty also applies to use in humid rooms such as bathrooms at MeisterDesign. life, MeisterDesign. pro and Laminate flooring Melango, Micala, Talamo. Use in wet rooms, such as showers, public washrooms and saunas, is not permitted. Special warranty conditions apply for the USA and Canada. This warranty does not apply in said regions.

**II. Warranty period:** The warranty period is in accordance with the warranty time stated for each individual product and for the concrete type of use described, after the appropriate date of purchase respectively.

**III. Warranty conditions:** The flooring must be fitted professionally and especially in accordance with the fitting instructions accompanying every third product packaging, in the permitted areas of use stated therein. In particular the instructions relating to checking moisture in the substrate and the instructions for installation over underfloor heating must be observed. The floor must also be maintained and cleaned according to the care instructions enclosed with the product. If these installation and care instructions are missing and/or incomplete, the claimant must request these instructions from a specialist retailer or directly from MeisterWerke before starting the fitting.

**IV. Reporting a warranty claim:** Any complaint must be made in text form (e.g. as a letter sent via the postal system, a fax, or an e-mail), enclosing a copy of the original invoice from the specialist retailer, which serves as a certificate of warranty. If it is not possible to present the original retailer's invoice, any claim under the warranty is excluded. Following receipt of the claim, MeisterWerke must notify the customer within four weeks of whether a warranty claim has been acknowledged. If no notification is given within this period, the warranty claim is deemed to have been rejected. During this period, MeisterWerke or a third party employed by them must be granted access to the flooring that is the subject of the complaint on site in order to investigate whether the claim is justified.

**V. Scope of the warranty:** When a warranty claim is acknowledged, MeisterWerke will repair the defective floor element or alternatively provide replacement material of the same quality – if at all possible from the same range – for the entire contiguous area in which the problem has occurred.

The customer can collect the replacement material free of charge from the original sales outlet stated in the original invoice, excluding any further claims over and beyond this, including but not limited to compensation claims for the removal or fitting of the flooring or for consequential damage that has occurred other than in the product supplied itself.

**VI. Limitation of warranty:** The warranty period is not extended by a warranty claim. Claims under the warranty expire six months from the date of MeisterWerke's receipt of the customer's written complaint (see IV.), but no earlier than the expiry of the warranty period.

**VII. Choice of law:** This warranty is subject to German law, to the exclusion of the United Nations Treaty governing contracts for the international sale of goods. However, this does not affect the legal provisions regarding the limitation of the choice of law; in particular and in accordance with Art. 6 (2) of EC Regulation (EC) No. 593/2008 (the "Rome I Regulation"), the beneficiary of the warranty can, irrespective of the choice of law and in accordance with Section 1, invoke the mandatory protection of the law that would apply in the absence of this choice of law.





GB

© 2019 by MeisterWerke Schulte GmbH

For reasons of printing technology, colours and structures may vary from the reproductions shown here. We reserve the right to make changes. No responsibility is assumed for errors.

MEISTER – a trademark of MeisterWerke Schulte GmbH  
Johannes-Schulte-Allee 5 | 59602 Rùthen-Meiste | GERMANY  
Phone: +49 2952 816-0 | Fax +49 2952 816-66 | [www.meister.com](http://www.meister.com)

04|19