

6FM150E-X 12V 150Ah(10hr)



The rechargeable batteries are lead-lead dioxide systems. The dilute sulfuric acid electrolyte is absorbed by separators and plates and thus immobilized. Should the battery be accidentally overcharged producing hydrogen and oxygen, special one-way valves allow the gases to escape thus avoiding excessive pressure build-up. Otherwise, the battery is completely sealed and is, therefore, maintenance-free, leak proof and usable in any position.

Battery Construction

Component	Positive plate	Negative plate	Container	Cover	Safety valve	Terminal	Separator	Electrolyte
Raw material	Lead dioxide	Lead	ABS	ABS	Rubber	Copper	Fiberglass	Sulfuric acid

General Features

- Absorbent Glass Mat (AGM) technology for efficient gas recombination of up to 99% and freedom from electrolyte maintenance or water adding.
- Not restricted for air transport-complies with IATA/ICAO Special Provision A67.
- UL-recognized component.
- Can be mounted in any orientation.
- Computer designed lead, calcium tin alloy grid for high power density.
- Long service life, float or cyclic applications.
- Maintenance-free operation.
- Low self discharge.

Dimensions and Weight

Length(mm / inch)	482 / 19.0
Width(mm / inch)	170 / 6.69
Height(mm / inch)	240 / 9.45
Total Height(mm / inch)	240 / 9.45
Approx. Weight(Kg / lbs)	44.8 / 98.8

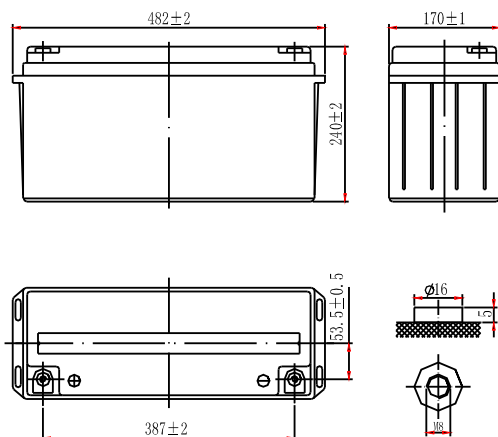

Performance Characteristics

Nominal Voltage	12V
Number of cell	6
Design Life	10 years
Nominal Capacity 77°F(25°C)	
10 hour rate (15.0A, 10.8V)	150Ah
5 hour rate (24.5A, 10.5V)	122.5Ah
1 hour rate (103A, 9.6V)	103Ah
Internal Resistance	
Fully Charged battery 77°F(25°C)	≤3.5mOhms
Self-Discharge	
3% of capacity declined per month at 20°C(average)	
Operating Temperature Range	
Discharge	-20~60°C
Charge	-10~60°C
Storage	-20~60°C
Max. Discharge Current 77°F(25°C)	970A(5s)
Short Circuit Current	2800A
Charge Methods: Constant Voltage Charge 77°F(25°C)	
Cycle use	2.40-2.45VPC
Maximum charging current	40A
Temperature compensation	-30mV/°C
Standby use	2.20-2.28VPC
Temperature compensation	-20mV/°C

Discharge Constant Current (Amperes at 77°F25°C)

End Point Volts/Cell	10min	15min	30min	1h	3h	5h	10h	20h
1.60V	340	283	186	103	42.9	27.6	15.4	8.07
1.65V	322	268	177	98.7	41.1	26.4	15.3	8.03
1.70V	303	254	167	94.1	39.3	25.3	15.2	7.98
1.75V	285	239	158	89.2	37.4	24.5	15.1	7.93
1.80V	274	230	153	87.2	36.7	23.7	15.0	7.88

Discharge Constant Power (Watts at 77°F25°C)

End Point Volts/Cell	10min	15min	30min	45min	1h	2h	3h	5h
1.60V	605	505	329	241	186	109	79.2	53.7
1.65V	583	487	318	234	182	107	77.2	52.4
1.70V	560	470	308	227	178	104	75.2	51.0
1.75V	537	452	297	220	174	101	73.3	50.0
1.80V	515	435	286	212	170	97.6	71.3	48.8

(Note)The above characteristics data are average values obtained within three charge/discharge cycles not the minimum values. All data shall be changed without notice,Vision reserves the right to explain and update the information contained hereinto.

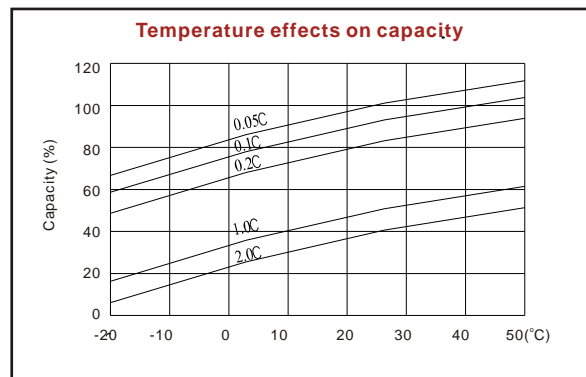
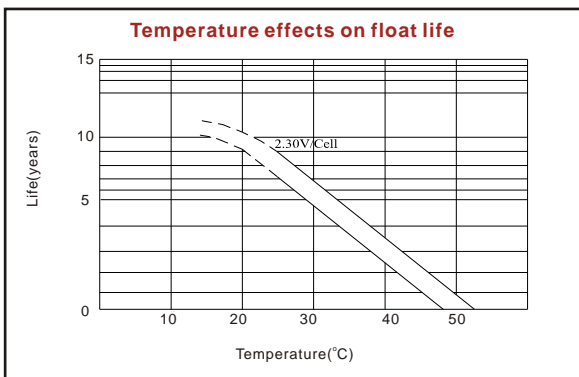
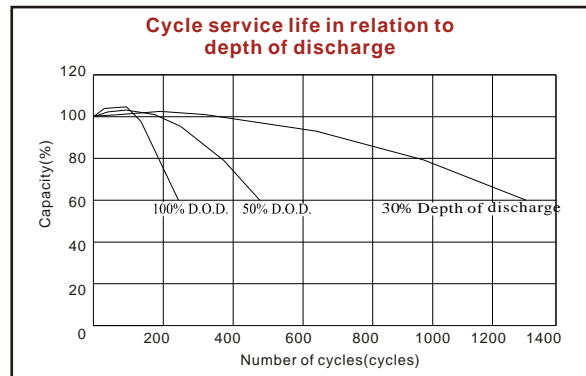
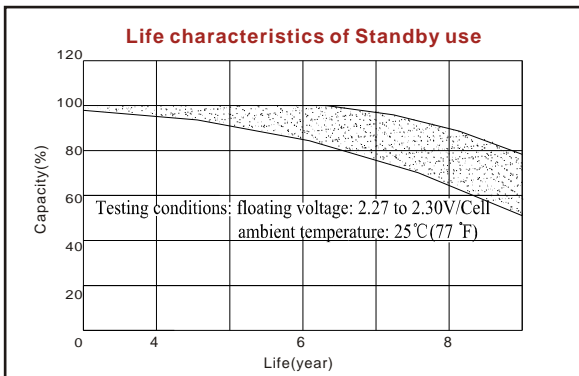
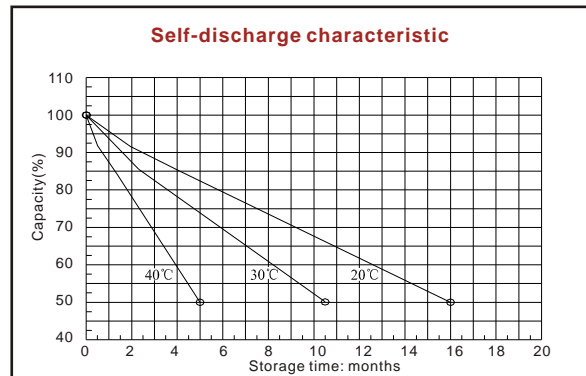
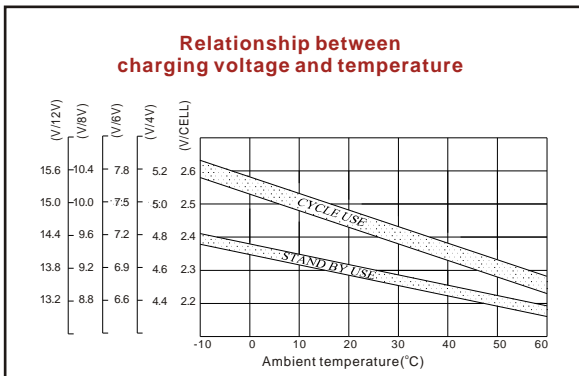
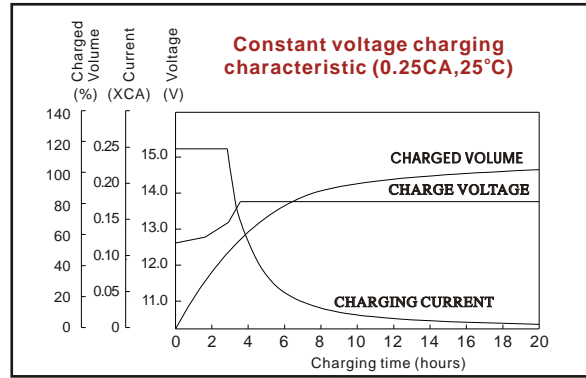
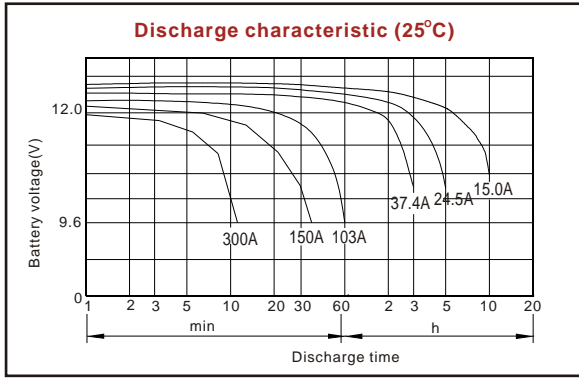

ISO9001:2008

MH25860

G4M19906-9202-E-16

www.vision-batt.com

Shenzhen Center Power Tech. Co., Ltd.
 Center Power Industrial Park, Tongfu Industrial District Dapeng Town, 518120 Shenzhen, China
 Tel: (+86-755) 8431 8088 Fax: (+86-755) 84318038 E-mail: sales@vision-batt.com