



集能易
GNE TEK

INSTALLATION MANUAL

For

Solar optimizers - Honeybee350, Honeybee700

Module Monitors - Scouter350, Scouter700

Smart Junction Boxes - Smartbee350, Smartbee350S

Jiangsu GNE New Energy Technology Co., Ltd.

Service Line: +86 519 8728 1798

Email: service@gnetek.com | Website: www.gnetek.com

Address: 1F/B, No.218, Hongkou Road, Liyang, Jiangsu 213300, CHINA

PLEASE READ THIS SHEET FIRST

IMPORTANT SAFETY INSTRUCTIONS SAVE THESE INSTRUCTIONS

LETHAL VOLTAGE MAY BE PRESENT IN ANY PV INSTALLATION

- This manual contains important instructions for installation and maintenance of the GNE Technology product models Honeybee350, Honeybee700, Smartbee350 and related GNE Technology software applications.
- Risk of electric shock, do not remove cover, disassemble, or repair, no user serviceable parts inside. Refer servicing to qualified service personal.
- Before installing or using the GNE Technology module optimizer system (Apidae), please read all instructions and warning marking on the GNE Technology products, appropriate sections of your inverter manual , photovoltaic (PV) module installation manual, and other available safety guides.
- Failure to adhere to these instructions may result in injury or death, damage to the system or voiding the factory warranty.
- To reduce risk of fire and shock hazard, install this device with strict adherence to local electric standards and codes. When the photovoltaic array is exposed to light , it supplies a DC voltage to the GNE Technology module optimizer. The module optimizer starts in the “ON” state and its output voltage may be as high as the PV module open circuit voltage (Voc) when connected to the module. The installer should use the same caution when handling electrical cables from a PV module with or without the GNE Technology module optimizer attached.
- Installation must be performed by trained professionals only. GNE Technology does not assume liability for loss or damage resulting from improper handling, installation, or misuse of products.
- Remove all metallic jewelry prior to installing the GNE Technology module optimizer to reduce the risk of contacting live circuitry. Do not attempt to install in inclement weather.
- Do not operate the GNE Technology module optimizer if it has been physically damaged. Check existing cables and connectors, ensuring they are in good condition and appropriate in rating. Do not operate the GNE Technology module optimizer with damaged or substandard wiring or connectors. GNE Technology module optimizer must be mounted on the high end of the PV module back-sheet or racking system, and in any case above ground.
- Do not connect or disconnect under load. Turning off the Inverter and/or the GNE Technology products may not reduce this risk. Internal capacitors within the inverter can remain charged for several minutes after disconnecting all power sources. Verify capacitors have discharged by measuring voltage across inverter terminals prior to disconnecting wiring if service is required.
- Service Personnel: Check the voltage of the array after activating the GNE Technology Safe-Hub function on the Data Aggregation Device (Beehive) prior to performing service.
- Always assume module optimizer is in “ON” state, or may turn on when restarting.

TABLE OF CONTENTS:

1. System Diagram (Apidae)

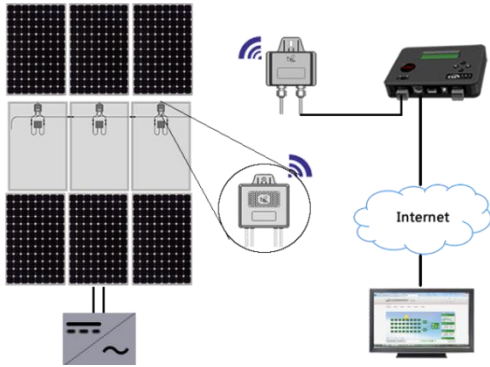

2. Connect Data Acquisition Unit (Swarm) to Data Aggregation Device (Beehive)



3. Install Data Acquisition Unit (Swarm)



4. Install Data Acquisition Device (Beehive)

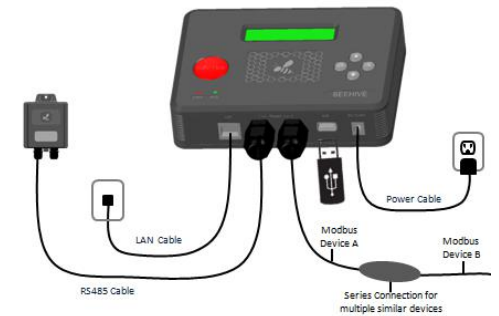

5. Mapping



6. Installing Honeybees/ Smartbees / Scouters

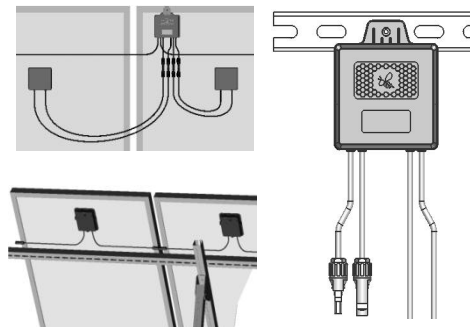

7. Configuring the system online (Honeypot)



8. Connecting Modbus Accessories (Optional)



1. System Diagram (Apidae)



Sole Optimizer /
Module Monitor



Smart Junction box
- Smartbee350(S)

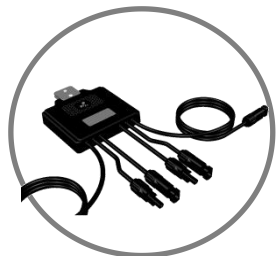

Dual Optimizer /
Dual PV Monitor

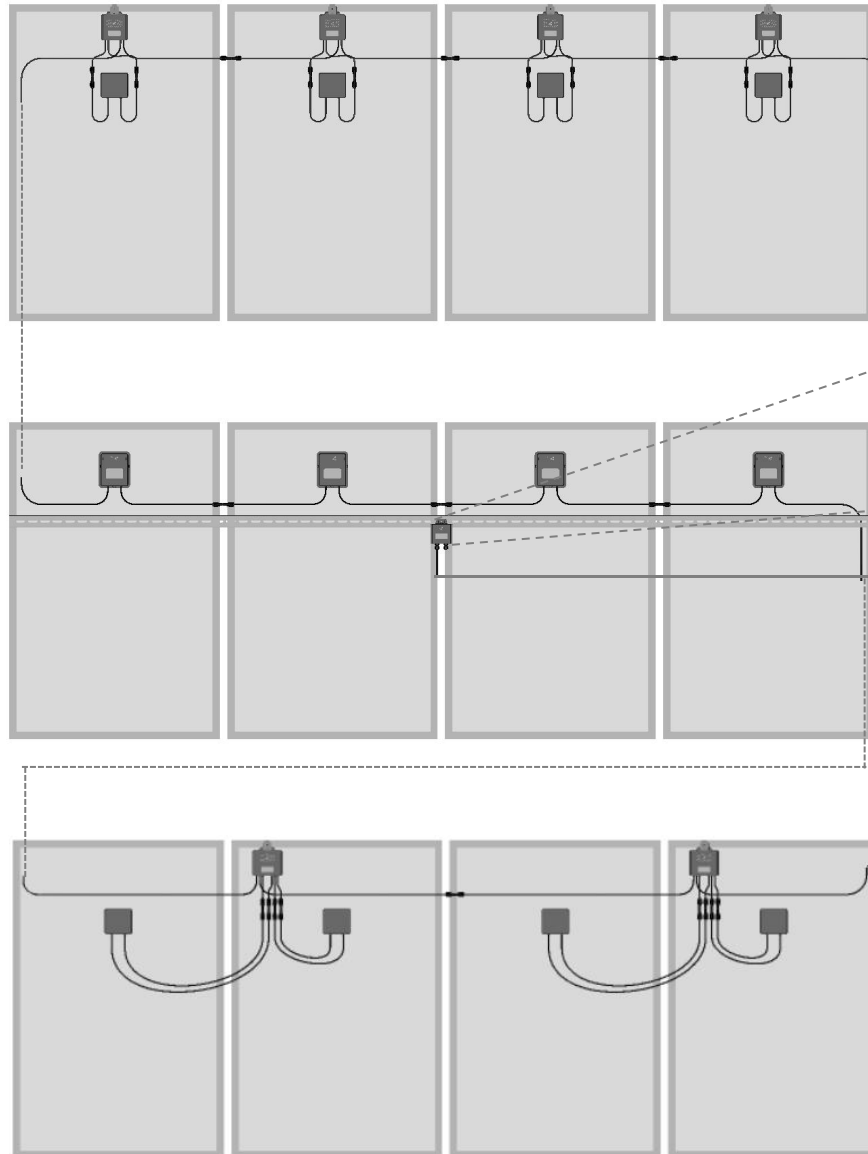

System Guidelines:

- 1 Beehive: up to 5 Swarms and 2000 PV modules
- 1 Swarm: up to 400 PV modules
- Optimizer:
1 Honeybee350 per 1 PV module
1 Honeybee700 per 2 PV modules

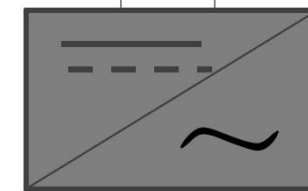
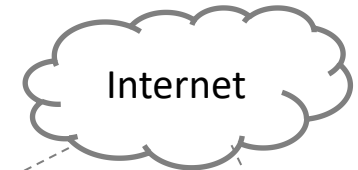
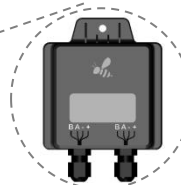

2. Connect Data Acquisition Unit (Swarm) to Data Aggregation Device (Beehive)

- ① Snip RS485 wire with proper length (Beehive to the middle of PV array)
- ② Take down screws and Open the back covers of the Swarm and Beehive
- ③ Connect any one RS485 port of Swarm to the No. 1 RS485 port of Beehive with RS485 wire
- ④ Keep the same wire order when connect Beehive and Swarm (**Warning! Any wire disorder will cause Swarm damaged.**)
- ⑤ Close the back overs of Swarm and Beehive and rescrew well.



3. Installing Data Acquisition Unit (Swarm)

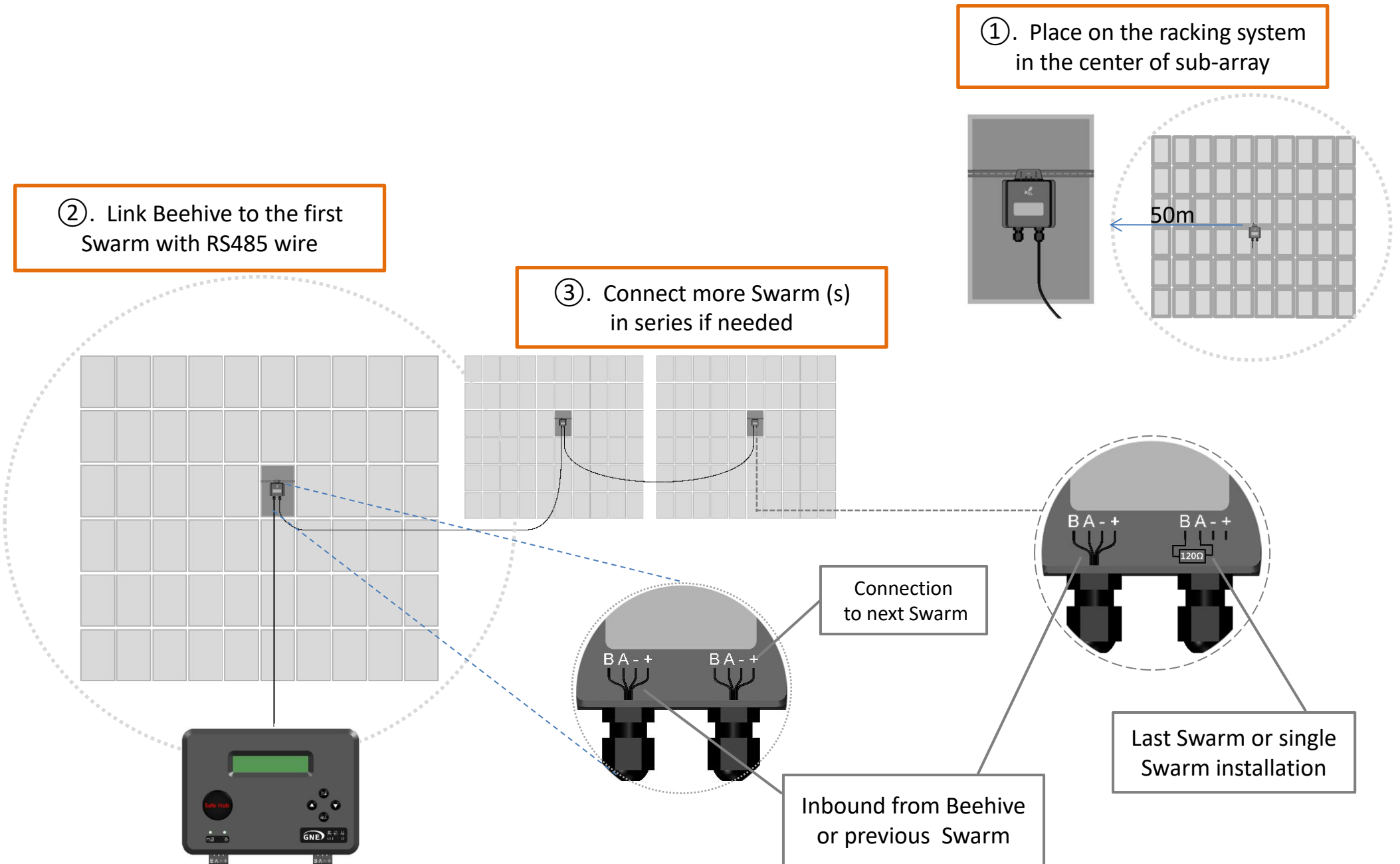

4. Install Data Acquisition Device (Beehive)

Notes:

1. The Inbreaking Protection of Beehive is IP20 , please install indoor, or please use shielding box
2. Please link to Swarm, Power and LAN port
3. Please check the manu of Beehive to get "FIND 485" to check if Swarm is connected well

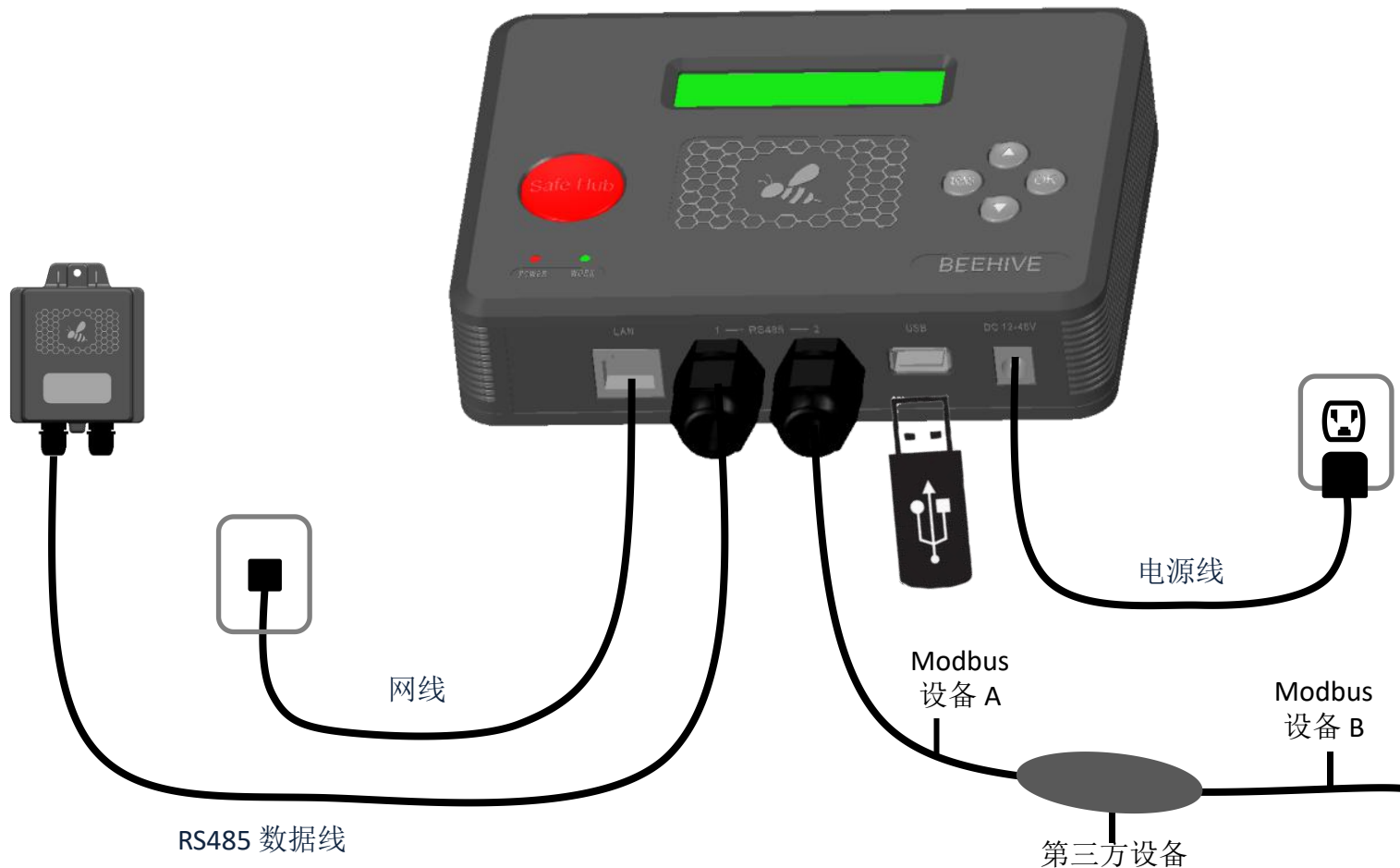

5. Mapping

①. Plan where to place power optimizers

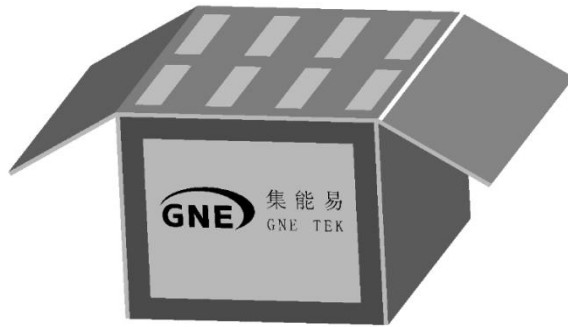

②. Take out power optimizer & write down the barcode number. Place the sticker on the map, string list, or construction drawing to match the physical location of the power optimizer

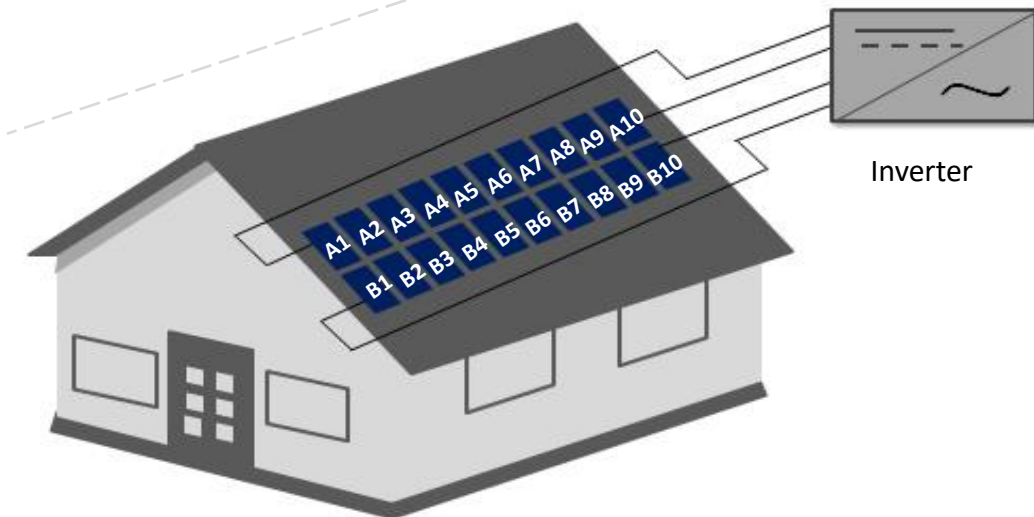
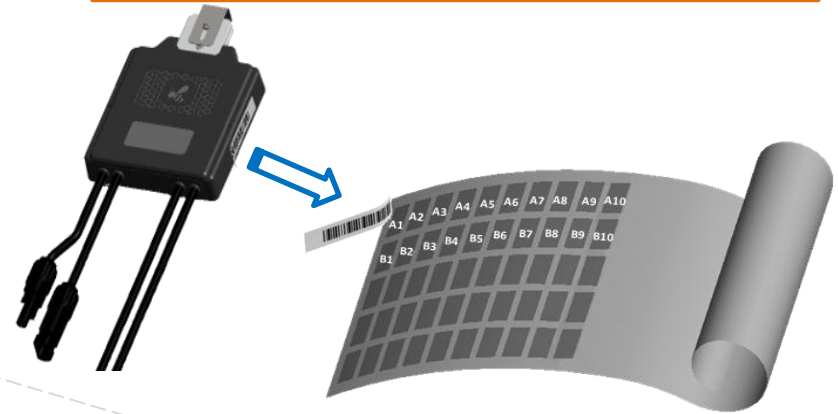

③. Place optimizer on the PV module in a way that matches the map you made using barcode. Also please record the serial numbers of Swarm(s) and Beehive(s).

6. Installing Optimizers/Scouters/Smartbees

- ②. Connect a short pair input wires of optimizer or module monitor to PV module, and link the long pair wires to inverter or

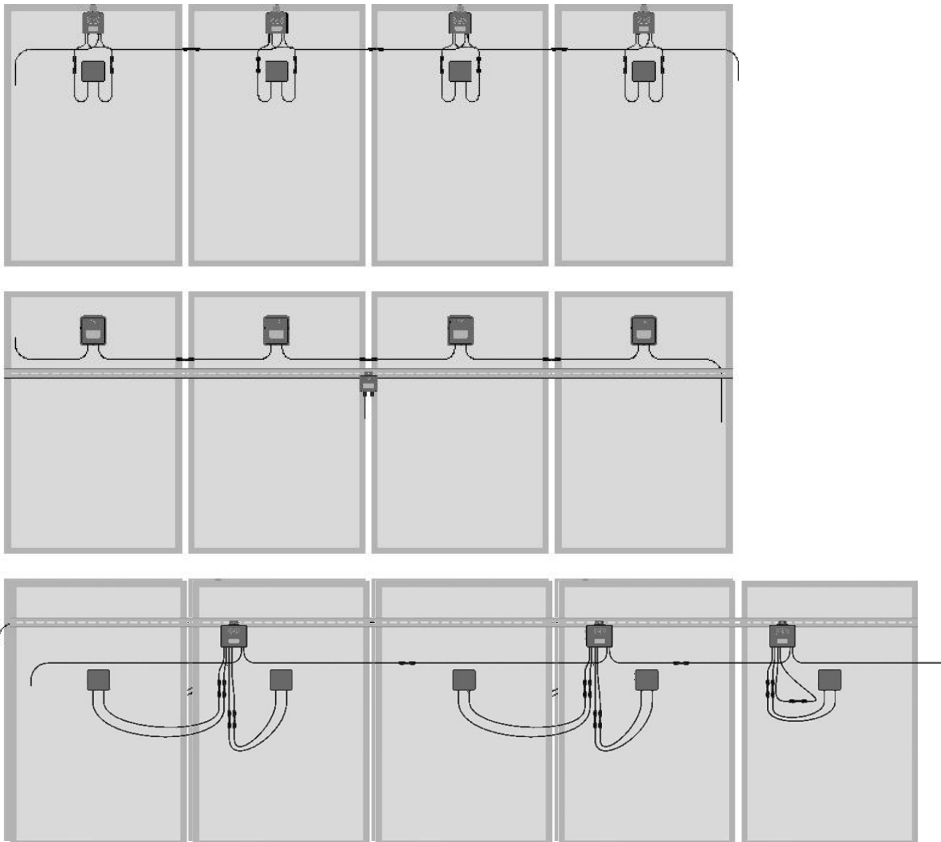

- ①. Fix power optimizers on the rack or the PV panel with screw

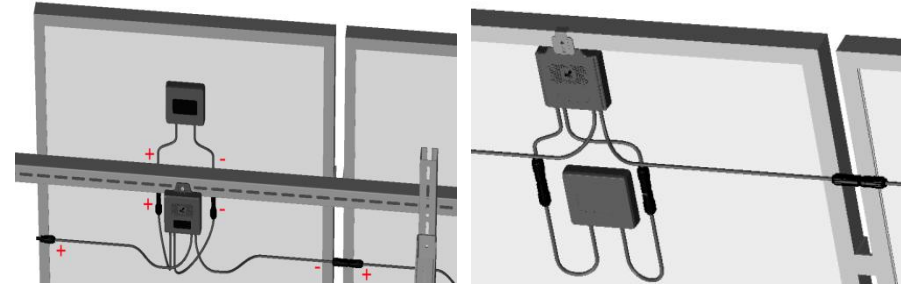

- ③. Record MAC ID of power optimizers in string list template / Map / construction drawing to track the location of optimizers

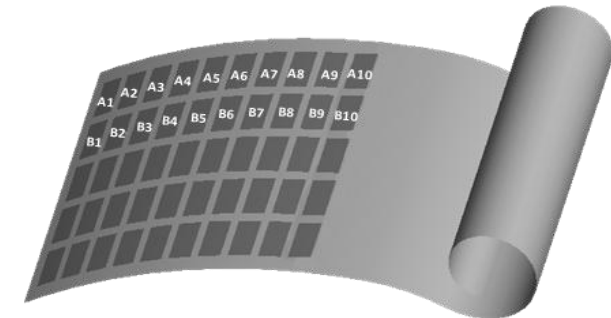

Remark:

- ① When using dual optimizer Honeybee700 on an odd-length string, connect the medium length input cables of the last optimizer in the string together;
- ② The shortest pair of input linkers should be connected to the first panel of each pair.
- ③ The connection method of Smartbees is the same as the existing panels

7. Configuring the system online

http://gne.gnetek.com

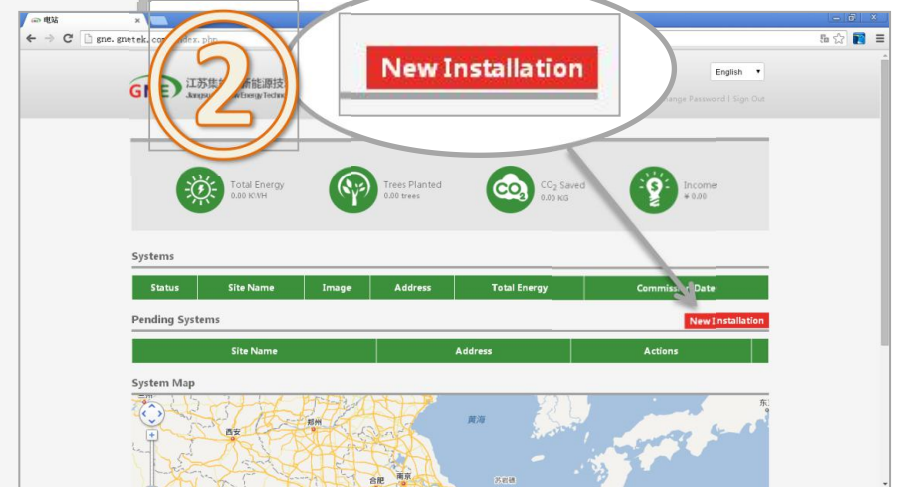
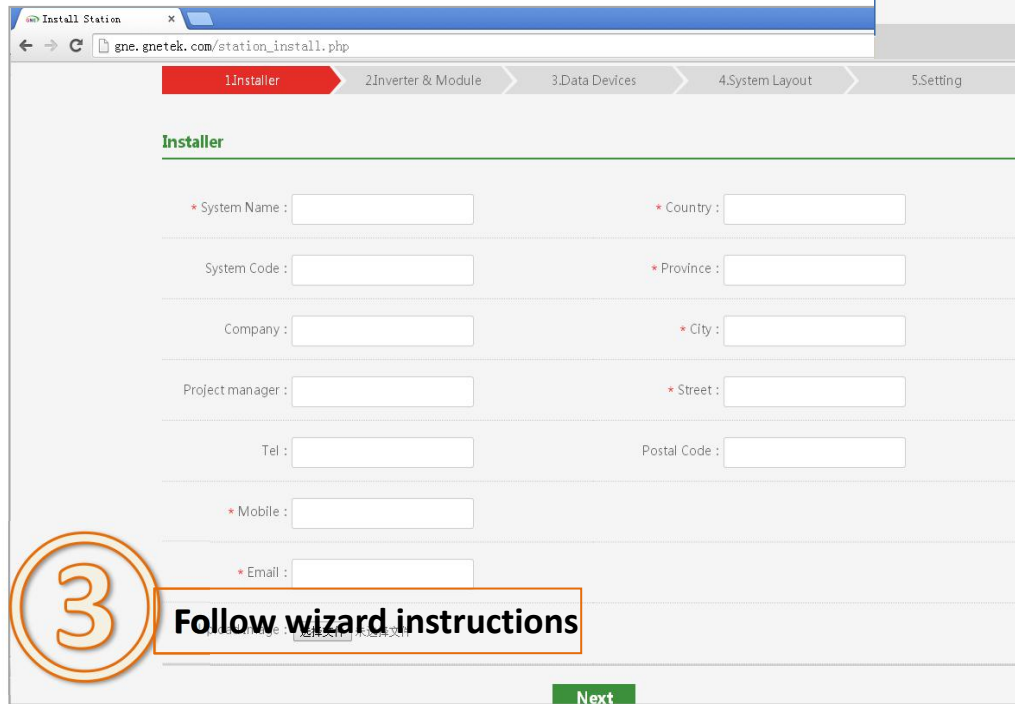
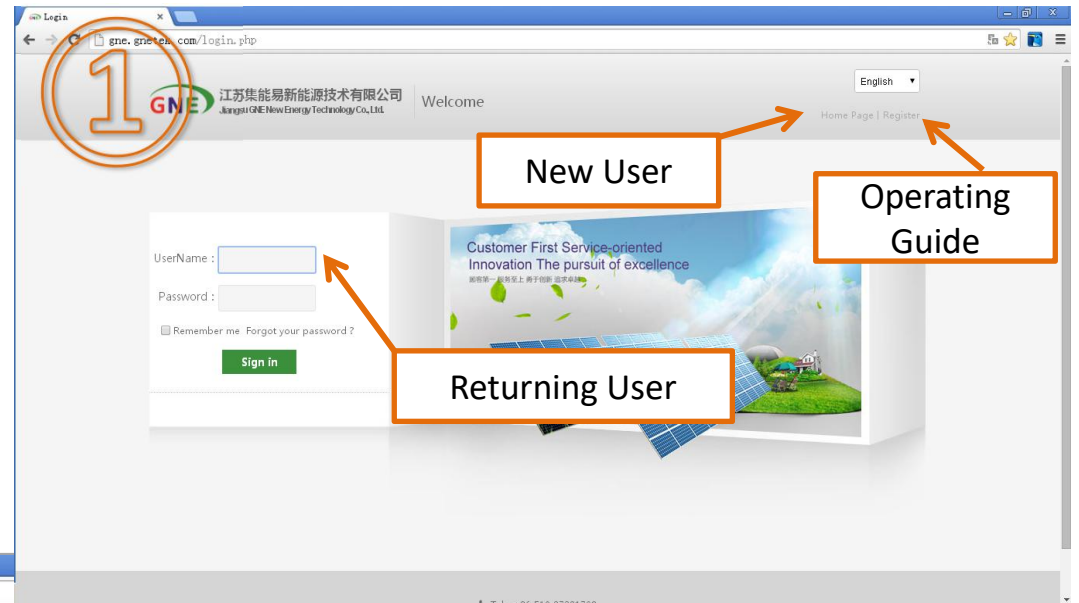

8. Connecting Modbus Accessory (Optional)

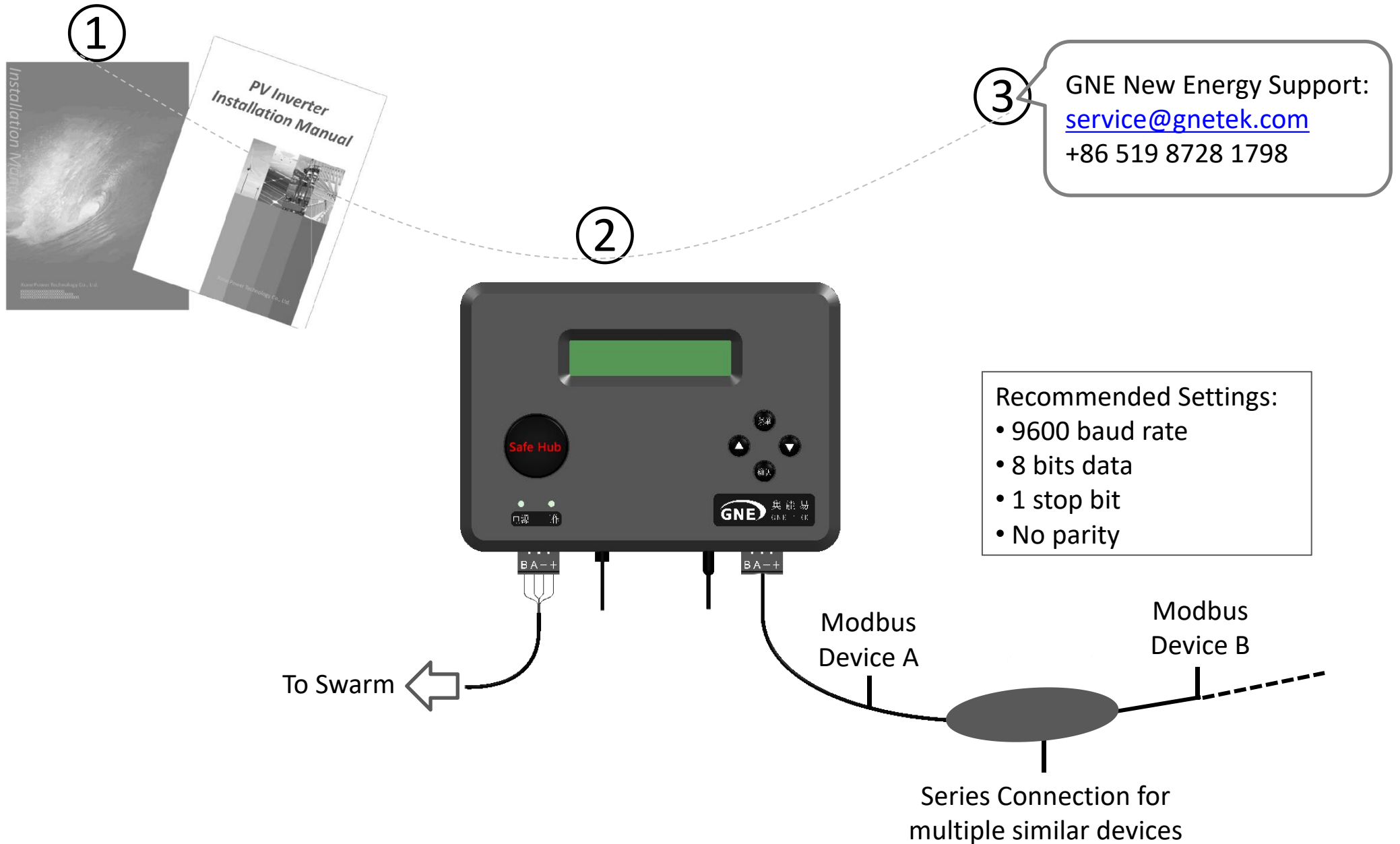

Appendix - Product Specification

SPECIFICATION		MODEL					
		Honeybee350	Honeybee700	Smartbee350	Smartbee350S	Scouter350	Scouter700
INPUT	Max. Input Power	350 W	700 W	350 W	350 W	350W	700W
	Input Voltage Range	14 ~ 60 Vdc	14 ~ 60 Vdc	14 ~ 60 Vdc	14 ~ 60 Vdc	10 ~ 60 Vdc	10 ~ 100 Vdc
	Module MPPT Voltage Range	16 ~ 50 Vdc	16 ~ 50 Vdc	16 ~ 50 Vdc	16 ~ 50 Vdc	-	-
	Cell-String MPPT Voltage Range	-	-	-	7 ~ 20 Vdc	-	-
	Max. Input Current	10 Adc	10 Adc	10 Adc	10 Adc	10 Adc	10 Adc
	Short Circuit Current	15 Adc	15 Adc	15 Adc	15 Adc	15 Adc	15 Adc
	Night Power Consumption	0 W	0 W	0 W	0 W	0 W	0 W
OUTPUT	Max Output Current	11 Adc	11 Adc	11 Adc	11 Adc	10 Adc	10 Adc
	Output Voltage Range	0 ~ 60 Vdc	0 ~ 120 Vdc	0 ~ 60 Vdc	0 ~ 60 Vdc	10 ~ 60 Vdc	10 ~ 100 Vdc
	Max System Voltage	1000 Vdc	1000 Vdc	1000 Vdc	1000 Vdc	1000 Vdc	1000 Vdc
EFFICIENCY	Max. Converter Efficiency	99.50%	99.60%	99.50%	99.50%	99.90%	99.90%
	Europe Efficiency	98.50%	98.80%	98.50%	98.50%	99.30%	99.40%
	CEC Efficiency	98.30%	98.50%	98.30%	98.30%	99.00%	99.20%
INSTALLATION SPECIFICATION	Size (L*W*T, mm)	115*106*22	138*120*28.2	152x133x25.9	148.6x127.6x27	92x80x23	138*120*28.2
	Weight	530 g	810 g	540g	580g	400g	700g
	Input Linker	MC4	MC4	-	-	MC4	MC4
	Output Linker	MC4	MC4	MC4	MC4	MC4	MC4
	Working Temperature	-40 ~ +85 °C	-40 ~ +85 °C	-40 ~ +85 °C	-40 ~ +85 °C	-40 ~ +85 °C	-40 ~ +85 °C
	Inbreaking Protection	IP65	IP65	IP65	IP65	IP65	IP65
	Relative Humidity	0~100%	0~100%	0~100%	0~100%	0~100%	0~100%
STANDARD COMPLIANCE	EMC	FCC Part15 class B, IEC61000-6-2, IEC61000-6-3, CSA C22.2 No.107.1-01, UL 1741					
	Safety Regulations	IEC62109-1 (Class II safety)					
	Overvoltage Category	III					
	Certificate	CE/CQC/TUV/CSA					