

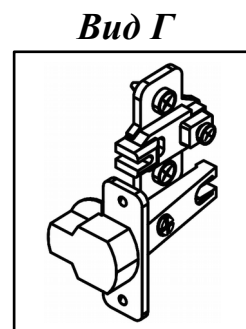

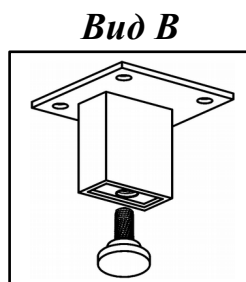

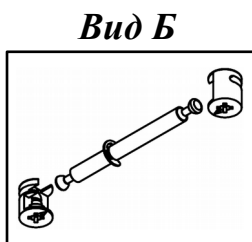

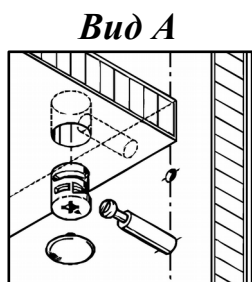

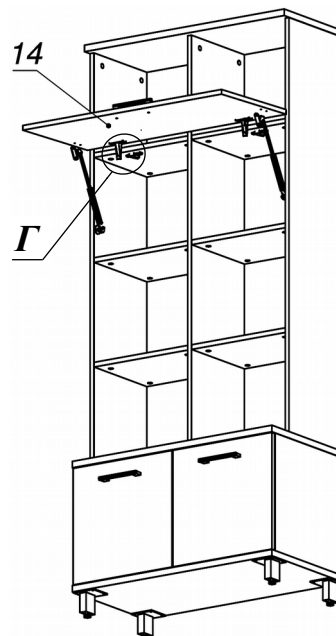
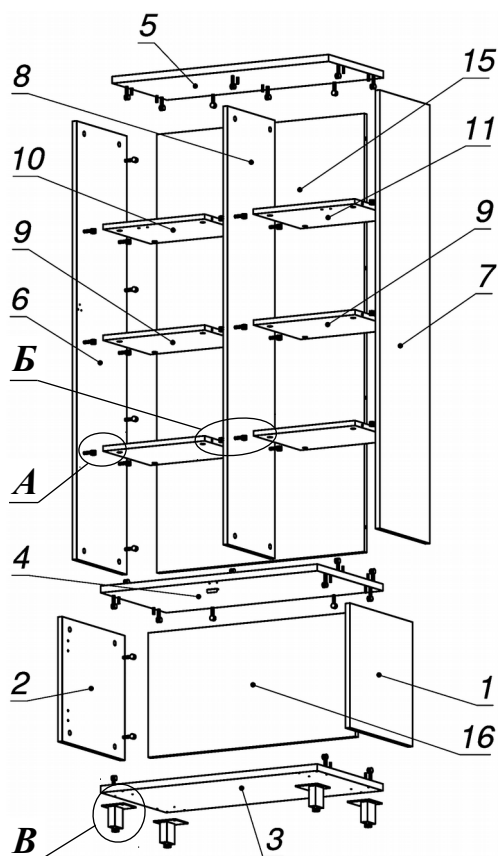
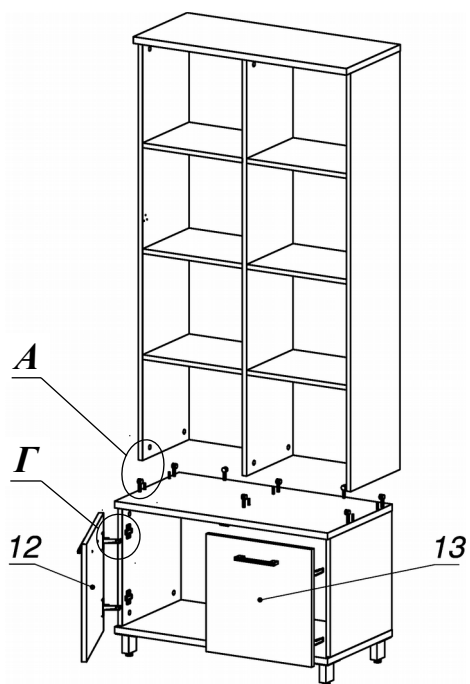

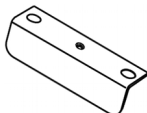

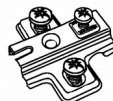
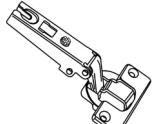
Схема сборки

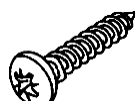

Спецификация по деталям

Поз.	Кол., шт.	Название	h, мм	Размер габ., мм x мм
1	1	Бок пр	16	400 x 400
2	1	Бок лв	16	400 x 400
3	1	Дно наруж.	22	800 x 420
4	1	Крышка нар. низ	22	800 x 420
5	1	Крышка нар. верх	22	800 x 340
6	1	Бок лв верх	16	1408 x 320
7	1	Бок пр верх	16	1408 x 320
8	1	Переборка	16	1408 x 303
9	4	Полка ДСП	16	375 x 302
10	1	Полка ДСП	16	375 x 302
11	1	Полка ДСП	16	375 x 302
12	1	Дверь лв н.	16	396 x 396
13	1	Дверь пр н.	16	396 x 396
14	1	Фасад откид. вверх	16	796 x 370
15	1	З.стенка верх	16	1408 x 766
16	1	З.стенка низ	16	400 x 766

Спецификация расхода фурнитуры

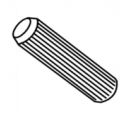
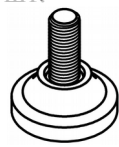
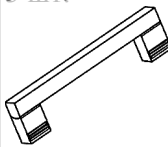
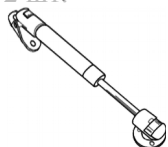
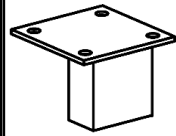
1 шт.  Ответная планка к замку СТАНДАРТ	8 шт.  Демпфер d-10	6 шт.  Ответка (Евро) к внутр. и нар. петле ДСП СТАНДАРТ (H2)	6 шт.  Петля нар. ДСП СТАНДАРТ	6 шт.  Винт М4х40/с бурт.	2 шт.  Саморез d3,0x13/потайной	10 шт.  Саморез d3,5x16/полукруг
12 шт.  Саморез d3,5x16/потайной	16 шт.  Саморез d4,0x16/полукр.	52 шт.  Стяжка Minifix - ДЮБЕЛЬ - 34	6 шт.  Стяжка Minifix - ДЮБЕЛЬ - 34-16-34	64 шт.  Стяжка Minifix - ЗАГЛУШКА (пласт.)	64 шт.  Стяжка Minifix - ЭКСЦЕНТРИК - 16/d15/без покр.	6 шт.  Шайба пластиковая (под винт для стекла)
20 шт.  Шкант d6x30/бук	4 шт.  Опора NIKA	3 шт.  Ручка "Jet"	2 шт.  Подъемник газовый N80	4 шт.  Опора "Jet" 80 (Шк)		