

# Technical Information

## Teqwave F/I

Measuring device with surface acoustic wave technology



Smart, flexible concentration measuring device – individually for your process

### Application

- The acoustic waveguide measures precisely and reliably, even the smallest changes are detected
- Continuous concentration measurement of liquids in pipes or vessels

### Device properties

- Accurate in spite of pressure (F) or flow profile (I)
- F: Nominal diameter: DN 8 to 25 ( $\frac{3}{8}$  to 1")
- I: Insertion length: 180 mm (7 in) or 500 mm (20 in)
- Industry-compliant, easy installation via DIN rail
- 3.5" in TFT color touch display or LED indication
- 4-20 mA, Modbus TCP

### Your benefits

- Easy and efficient – real-time in situ liquid analysis
- Full transparency – constant monitoring of product quality without sampling
- Highest process safety – reliable metering due to robust, maintenance-free sensor
- Fewer measuring points – multivariable measurement
- Customized usage – innovative app concept, easily expandable for changing measuring tasks
- Simplified process control – user-friendly operation and clear status visualization
- Local data backup – integrated data storage for measured values up to 7.5 years







## Table of contents

<b>About this document</b> .....	<b>3</b>	<b>Mechanical construction</b> .....	<b>17</b>
Symbols .....	3	Design dimensions .....	17
<b>Function and system design</b> .....	<b>4</b>	Weight .....	19
Measuring principle .....	4	Materials .....	19
Measuring system .....	5	Process connections .....	20
IT security .....	7	<b>Operability</b> .....	<b>20</b>
<b>Input</b> .....	<b>7</b>	Local operation .....	20
Measured variables .....	7	Supported operating tools .....	20
Measuring range .....	7	Reliable operation .....	20
Input signal .....	7	Languages .....	20
<b>Output</b> .....	<b>7</b>	<b>Certificates and approvals</b> .....	<b>20</b>
Output signal .....	7	CE mark .....	20
Signal on alarm .....	8	RCM-tick symbol .....	20
Galvanic isolation .....	9	Other standards and guidelines .....	21
Protocol-specific data .....	9	<b>Ordering information</b> .....	<b>21</b>
<b>Power supply</b> .....	<b>10</b>	<b>Application packages</b> .....	<b>21</b>
Terminal assignment .....	10	<b>Accessories</b> .....	<b>21</b>
Supply voltage .....	10	Device-specific accessories .....	22
Power consumption .....	10	Communication specific accessories .....	22
Current consumption .....	10	Service-specific accessories .....	22
Power supply failure .....	10	<b>Documentation</b> .....	<b>22</b>
Electrical connection .....	11	Standard documentation .....	23
Potential equalization .....	13	<b>Registered trademarks</b> .....	<b>23</b>
Terminals .....	13		
Cable specification .....	13		
<b>Performance characteristics</b> .....	<b>14</b>		
Max. measured error .....	14		
Accuracy .....	14		
Reaction time .....	14		
Influence of variations in the fluid temperature .....	14		
Influence of vibrations .....	14		
Influence of ambient temperature .....	14		
Influence of air bubbles .....	14		
<b>Installation</b> .....	<b>15</b>		
Mounting location .....	15		
Orientation Teqwave I .....	15		
Inlet and outlet runs .....	15		
Installing the transmitter .....	16		
<b>Environment</b> .....	<b>16</b>		
Ambient temperature range .....	16		
Storage temperature .....	16		
Degree of protection .....	16		
Electromagnetic compatibility (EMC) .....	16		
<b>Process</b> .....	<b>16</b>		
Medium temperature range .....	16		
Nominal pressure .....	16		
Flow velocity .....	17		





## About this document

### Symbols







#### Electrical symbols



Symbol	Meaning
	Direct current
	Alternating current
	Direct current and alternating current
	<b>Ground connection</b> A grounded terminal which, as far as the operator is concerned, is grounded via a grounding system.
	<b>Protective Earth (PE)</b> A terminal which must be connected to ground prior to establishing any other connections.  The ground terminals are situated inside and outside the device: <ul style="list-style-type: none"> <li>▪ Inner ground terminal: Connects the protective earth to the mains supply.</li> <li>▪ Outer ground terminal: Connects the device to the plant grounding system.</li> </ul>
	<b>Signal ground connection</b> A terminal that can be used as the ground contact for the digital input.
	<b>Relay output connection</b> A terminal that can be used as a relay output.

#### Communication symbols



Symbol	Meaning
	<b>Wireless Local Area Network (WLAN)</b> Communication via a wireless, local network.
	<b>Bluetooth</b> Wireless data transmission between devices over a short distance.
	<b>LED</b> Light emitting diode is off.
	<b>LED</b> Light emitting diode is on.
	<b>LED</b> Light emitting diode is flashing.

#### Symbols for certain types of information

Symbol	Meaning
	<b>Permitted</b> Procedures, processes or actions that are permitted.
	<b>Preferred</b> Procedures, processes or actions that are preferred.
	<b>Forbidden</b> Procedures, processes or actions that are forbidden.
	<b>Tip</b> Indicates additional information.
	Reference to documentation.
	Reference to page.

Symbol	Meaning
	Reference to graphic.
	Visual inspection.

**Symbols in graphics**

Symbol	Meaning
1, 2, 3, ...	Item numbers
<b>1</b> , <b>2</b> , <b>3</b> , ...	Series of steps
A, B, C, ...	Views
A-A, B-B, C-C, ...	Sections
	Hazardous area
	Safe area (non-hazardous area)
	Flow direction

**Function and system design**

**Measuring principle**

The core component of the measuring device is an acoustic waveguide for the precise and rapid measurement of liquid concentrations with acoustic surface waves.

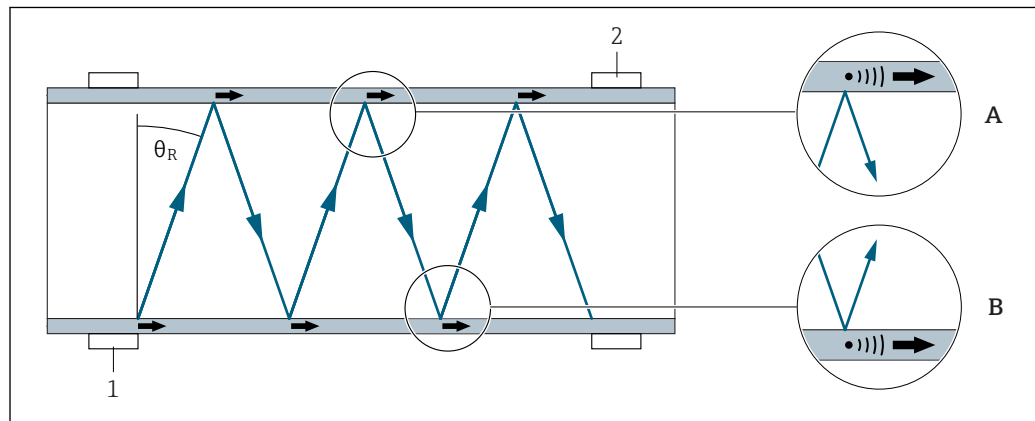

A0035710

A piezoelectric interdigital transducer (1) stimulates these high-frequency sound waves, which then propagate in the wall of the measuring device (A and B). A second piezoelectric interdigital transducer (2) acts as the receiver.

If the sound waves come into contact with liquid, the waves disperse into the liquid. This involves mode conversion at a Rayleigh angle ( $\theta_R$ ). This angle depends on the ratio of the speed of sound of the surface waves to the speed of sound of the liquid.

The double transducer arrangement with one transducer acting as a transmitter and another as a receiver enables extremely accurate analysis of the transmission times and amplitudes of the sound waves.

During this process, the measuring device also determines the acoustic impedance and the acoustic density of the liquid, in addition to the speed of sound. Another sensor also measures the temperature. By combining all these characteristic values and applying the concentration app, it is possible to determine the concentration of substances in a liquid mixture.

**Concentration measurement**

The measuring device calculates the concentration of the liquid according to the measured speed of sound, temperature and acoustic density.

**Temperature measurement**

A temperature sensor measures the temperature of the liquid. The location of the sensor and good thermal conduction allow to reliably detect fast changes in temperature. If the Kalman filter is enabled, the measuring device also uses additional information from the transit time of the acoustic wave. The measuring device displays the temperature as a separate measured variable, and also uses the temperature measured variable to calculate the concentration of the liquid.

**Sonic velocity measurement**

The measuring device determines the speed of sound (sonic velocity) in a non-invasive manner based on the propagation of the acoustic waves in the wave guide.

**Density measurement**

The measuring device calculates the acoustic density of the liquid directly from the speed of sound and the acoustic impedance. In the case of acoustical determined density, change of the alteration absorption property is also recorded.

**Measuring system**

The measuring device consists of a transmitter and a sensor. The sensor sends the measured signals to the transmitter for analysis. The transmitter transmits the measured values to the "Teqwave Viewer" operating tool via an Ethernet interface and the operating tool displays the measured values. The measuring device uses concentration apps, which are individually tailored to the measurement task and encoded to work only with the serial number of a specific transmitter.

**Transmitter**

Two versions of the transmitter are available.

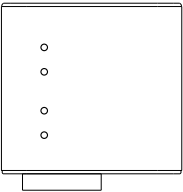
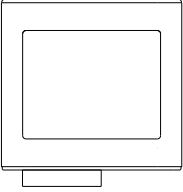
<p><b>Transmitter with LED status indication</b></p>  <p style="text-align: right; font-size: small;">A0035711</p>	<p>Order code for "Display; operation", option A</p> <p>Materials: Transmitter housing: anodized aluminum</p> <p>Configuration: Operation via the "Teqwave Viewer" operating tool supplied</p>
<p><b>Transmitter with a touchscreen</b></p>  <p style="text-align: right; font-size: small;">A0035712</p>	<p>Order code for "Display; operation", option B</p> <p>Materials:  <ul style="list-style-type: none"> <li>■ Transmitter housing: anodized aluminum</li> <li>■ Window: glass plate</li> </ul> </p> <p>Configuration:  <ul style="list-style-type: none"> <li>■ Operation via the "Teqwave Viewer" operating supplied tool</li> <li>■ Operation via the graphic local display with a touch screen</li> </ul> </p>

**Sensor**

Two versions of the sensor are available.

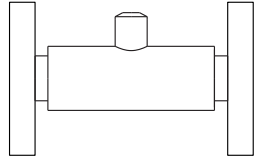
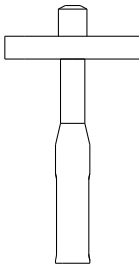
<p><b>"Teqwave F" sensor</b></p>  <p style="text-align: right; font-size: small;">A0035713</p>	<p>Measurement directly in the flow</p> <p>Nominal diameters:</p> <ul style="list-style-type: none"> <li>■ DN 8 (3/8")</li> <li>■ DN 15 (1/2")</li> <li>■ DN 25 (1")</li> </ul> <p>Process connections:</p> <ul style="list-style-type: none"> <li>■ Flange, EN 1092-1 (DIN 2501), PN 16</li> <li>■ External thread → 17</li> <li>■ Internal thread → 17</li> </ul> <p>Materials: Stainless steel, 1.4571 (V4A)</p>
<p><b>"Teqwave I" sensor</b></p>  <p style="text-align: right; font-size: small;">A0035714</p>	<p>Measurement directly in the tank or in the pipe</p> <p>Installed lengths:</p> <ul style="list-style-type: none"> <li>■ 180 mm (7 in)</li> <li>■ 500 mm (20 in)</li> </ul> <p>Process connections:</p> <ul style="list-style-type: none"> <li>■ Flange, EN 1092-1 (DIN 2501), DN 25 (1") , PN 16</li> <li>■ External thread → 18</li> </ul> <p>Materials: Stainless steel, 1.4571 (V4A)</p>

**Concentration apps**

A concentration app contains specific configurations for the measurement of a certain liquid and, along with the measured sensor signals, is used as the basis for calculating the concentration. Endress+Hauser provides a separate concentration app for every type of fluid.

The concentration app is a file with lmf format. A list of the available concentration apps is provided in the Applicator. If you require a concentration app that is not already listed in the Applicator, Endress+Hauser requires a sample of the fluid to create the concentration app. Every transmitter can use a maximum of 25 concentration apps.

Concentration apps are individually encoded to work only with the serial number of a specific transmitter. The transmitter in service uses the serial number saved in the .lmf file to check whether the concentration app has been specifically configured for use with this transmitter. If this is not the case, it is not possible to add the concentration app.

The data sheet provided with the concentration app contains information about the fluid, the permitted measuring ranges and the accuracy of the concentration measurement.

**Operating tool**

Two versions of the "Teqwave Viewer" operating tool are available. Supported functions:

Included in the scope of supply: Teqwave Viewer V2.1 – basic package	Order code for "Application package", option EP: Teqwave Viewer V2.1 - Viewer with interface for data download
<ul style="list-style-type: none"> <li>■ Live display and graphic visualization of measured variables</li> <li>■ Save graph</li> <li>■ Manage concentration apps on the transmitter</li> <li>■ Device configuration</li> <li>■ Switch between multiple transmitters</li> <li>■ Self-test</li> </ul>	<ul style="list-style-type: none"> <li>■ Live display and graphic visualization of measured variables</li> <li>■ Save graph</li> <li>■ Manage concentration apps on the transmitter</li> <li>■ Device configuration</li> <li>■ Switch between multiple transmitters</li> <li>■ Self-test</li> <li>■ Read saved measured values</li> <li>■ Offline analysis with graphic visualization of the measured values</li> <li>■ Measured value logging and export function</li> </ul>

**IT security**

Our warranty is valid only if the device is installed and used as described in the Operating Instructions. The device is equipped with security mechanisms to protect it against any inadvertent changes to the settings.

IT security measures, which provide additional protection for the device and associated data transfer, must be implemented by the operators themselves in line with their security standards.

## Input

**Measured variables****Direct measured variables**

- Temperature
- Speed of sound

**Derived measured variables**

- Concentration
- Dispersion
- Density

**Measuring range**

<b>Concentration</b>	As per concentration app data sheet, maximum 0 to 100 %
<b>Speed of sound</b>	600 to 2 000 m/s
<b>Temperature</b>	Concentration app data sheet, maximum 0 to 100 °C (+32 to +212 °F)
<b>Density</b>	0.7 to 1.5 g/cm <sup>3</sup>

**Input signal****Digital input**

<b>Function</b>	Choice of analog channel 1 to 4; inputs "0" and "1" are connected to ground.
<b>Version</b>	Open and ground. Do not connect external voltage to these terminals.

## Output

**Output signal****Ethernet (Modbus protocol)**

<b>Physical interface</b>	RJ-45 (8P8C)
---------------------------	--------------

**Current output 4 to 20 mA / voltage output 0 to 10 V**

<b>Function</b>	Can be configured as a current output or voltage output, as required
<b>Version</b>	Galvanically isolated
<b>Open-circuit voltage</b>	DC 15.5 V
<b>Suspend time</b>	Configurable: 0 to 10 000 s
<b>Assignable measured variables</b>	<ul style="list-style-type: none"> <li>▪ Off</li> <li>▪ On</li> <li>▪ Concentration 1-2</li> <li>▪ Temperature</li> <li>▪ Speed of sound</li> <li>▪ Dispersion</li> <li>▪ Density (optional)</li> <li>▪ Suspend measurement</li> </ul>
<b>Current output</b>	4 to 20 mA

Maximum output value	20 mA
Load	0 to 500 Ω
Resolution	1.5 μA
Voltage output	0 to 10 V
Maximum output value	10 V
Load	> 750 Ω
Resolution	1 mV

### Relay output

Function	Relay output
Version	Relay output, galvanically isolated
Maximum switching capacity	AC/DC 50 V, 1 A
Switching behavior	<ul style="list-style-type: none"> <li>▪ NC contact</li> <li>▪ NO contact</li> </ul>
Assignable functions	<ul style="list-style-type: none"> <li>▪ Off</li> <li>▪ On</li> <li>▪ Limit value (can be configured as a range or trigger value, as required): <ul style="list-style-type: none"> <li>▪ Concentration 1 to n</li> <li>▪ Temperature</li> <li>▪ Speed of sound</li> <li>▪ Dispersion</li> <li>▪ Density</li> </ul> </li> </ul>

### Signal on alarm

#### Ethernet (Modbus protocol)

Status bit	Diagnostics information via status bits
------------	---

#### Current output 4 to 20 mA / voltage output 0 to 10 V

Failsafe mode	<p>The breakdown information displayed in the event of a breach of the measuring range (over-range/under-range) can be configured in the <b>Analog output settings</b> parameters:</p> <ul style="list-style-type: none"> <li>▪ Failure value for measured variable if the "0 V/2 mA exceeding limits" option is selected: 2 mA or 0 V</li> <li>▪ Limit value for measured variable if the "Min/Max exceeding limits" option is selected: 4 to 20 mA or 0 to 10 V</li> </ul> <p>The breakdown information displayed in the event of a breach of the calibration range (over-range/under-range) can be configured in the <b>Display filter</b> parameter:</p> <ul style="list-style-type: none"> <li>▪ Failure value for measured variable if the "Calibration range" option is selected: 2 mA or 0 V</li> <li>▪ If the measuring device exceeds or drops below the temperature calibration range, a failure value is also displayed for the concentration measured variable if it is active.</li> </ul> <p>The breakdown information displayed if the process is not stationary (stationarity) can be configured in the <b>Display filter</b> parameter: Failure value for the <b>concentration measured variable if the "Enable stationarity" option is selected</b>: 2 mA or 0 V</p> <p>The breakdown information to be displayed if the rate of change exceeds the limit value can be configured in the <b>Change in [measured variable]</b> parameter. If the function is enabled: Failure value for the <b>concentration</b> measured variable: 2 mA or 0 V</p> <p>In the event of interference influences (dispersion) above the limit value: Failure value for the <b>concentration</b> measured variable: 2 mA or 0 V</p> <p>If there is not enough liquid or the sensor is defective: Failure value for all measured variables: 2 mA or 0 V</p>
---------------	--



**Relay output**

<b>Failsafe mode</b>	<p>If the temperature measurement range is exceeded or undershot: For the <b>concentration</b> measured variable: the current status is held.</p> <p>If the temperature calibration range is exceeded or undershot: For the <b>concentration</b> measured variable: the current status is held.</p> <p>The breakdown information to be displayed if the process is not stationary (stationarity) can be configured in the <b>Display filter</b> parameter. If the "Enable stationarity" option is selected: For the <b>concentration</b> measured variable: the current status is held.</p> <p>The breakdown information to be displayed if the rate of change exceeds the limit value can be configured in the <b>Change in [measured variable]</b> parameter. If the function is enabled: For the <b>concentration</b> measured variable: the current status is held.</p> <p>In the event of interference influences (dispersion) above the limit value: For the <b>concentration</b> measured variable: the current status is held.</p> <p>If there is not enough fluid: Measured value for all measured variables with the exception of temperature: 0 Switch status as per the setting for the switching threshold or switch point ("Operating Instructions" document, "Configuring the switch output" section).</p> <p>If there is a sensor defect: Measured value for all measured variables: 0 Switch status as per the setting for the switching threshold or switch point ("Operating Instructions" document, "Configuring the switch output" section).</p>
----------------------	---

**Local display (transmitter with touch screen)**

<b>Color coding</b>	Color field signalizes measuring and device errors ("Operating Instructions" document, "Diagnostics information on local display and in operating tool" section)
<b>Plain text display</b>	Information on the cause

**Local display (transmitter with LED)**

<b>Light emitting diodes (LED)</b>	<p>Status indication with four light emitting diodes ("Operating Instructions" document, "Diagnostics information for transmitter with LED status indication" section)</p> <p>The LEDs indicate the following information:</p> <ul style="list-style-type: none"> <li>■ Supply voltage active</li> <li>■ Error-free measuring system</li> <li>■ Device alarm/error has occurred</li> <li>■ Problem with connection to the sensor</li> </ul>
------------------------------------	---

**"Teqwave Viewer" operating tool**

<b>Color coding</b>	Color field signalizes measuring and device errors ("Operating Instructions" document, "Diagnostics information on local display and in operating tool" section)
<b>Plain text display</b>	Information on the cause



**Galvanic isolation**

The current and relay outputs are galvanically isolated from the rest of the system.

**Protocol-specific data**

<b>Protocol</b>	Modbus Applications Protocol Specification V1.1
<b>Response times</b>	Typically 10 to 50 ms
<b>Device type</b>	Slave
<b>Function codes</b>	0×04: Read Input Registers
<b>Modbus data transmission</b>	Little endian
<b>Data access</b>	Each measured variable can be accessed via Modbus (Ethernet).

## Power supply

Terminal assignment	Terminal	Assignment	
	V+	<b>V<sub>in</sub></b> 24 V DC	Supply voltage
	V-		
	+	<b>out</b> 0 to 10 V; 4 to 20 mA	Analog output
	-		
	0	<b>output</b> selection	Digital input
	1		
			Signal ground
		<b>alarm</b> max. 50 V, 1 A	Relay output
			

Supply voltage	Transmitter	24 V <sub>DC</sub> (18 to 35 V)



The power unit must be tested to ensure it meets safety requirements (e.g. PELV, SELV).

Power consumption	Transmitter	Max. 4 W

Current consumption	Transmitter maximum switch-on current	6 A

**Power supply failure** The configuration and recorded data are retained in the device memory.

Electrical connection

Connections and measuring device connecting cable

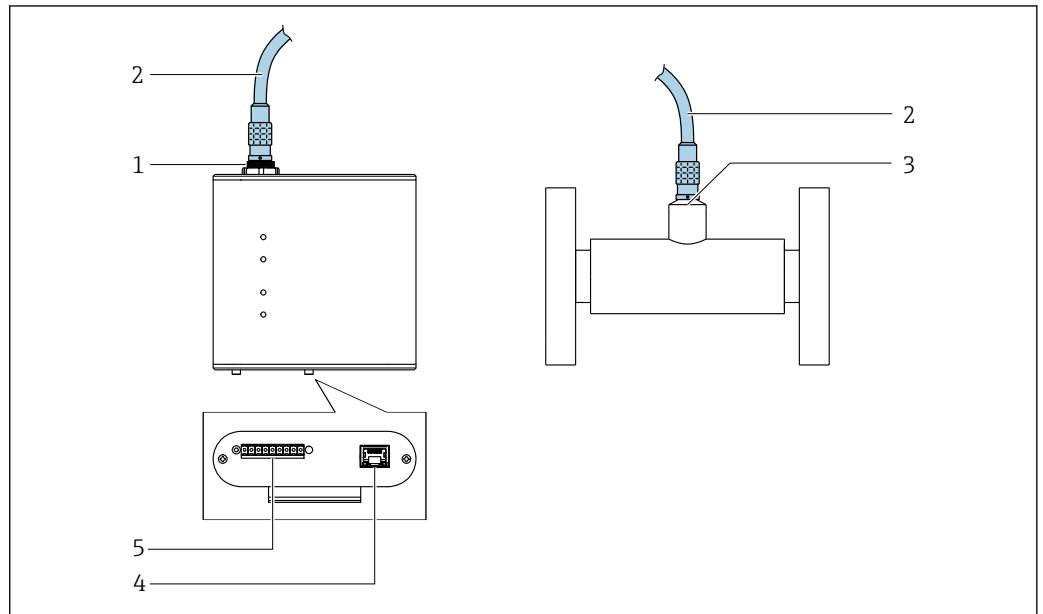

A0035715

**1** Connections and measuring device connecting cable

- 1 Transmitter push-pull connection
- 2 Connecting cable
- 3 Sensor push-pull connection
- 4 Ethernet interface for digital signal transmission ("Teqwave Viewer" operating tool and Modbus protocol)
- 5 Terminal strip with supply voltage, analog output, relay output and digital input, terminal assignment  
→ [10](#)



The connecting cable is available in different lengths.

Connecting examples

Current output 4 to 20 mA

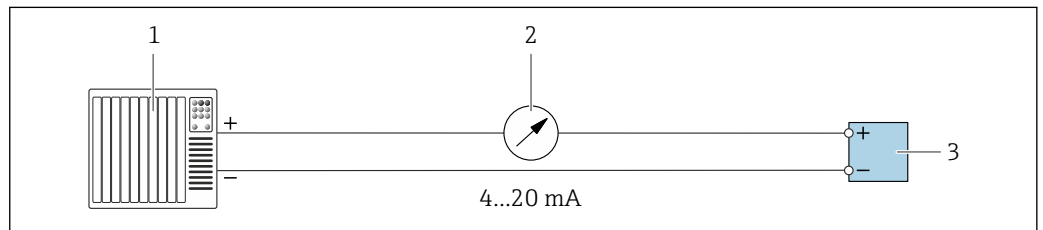

A0028758

**2** Connection example for current output, active, 4 to 20

- 1 Automation system with current input (e.g. PLC)
- 2 Analog display unit: maximum load 500 Ω
- 3 Transmitter

Voltage output 0 to 10 V

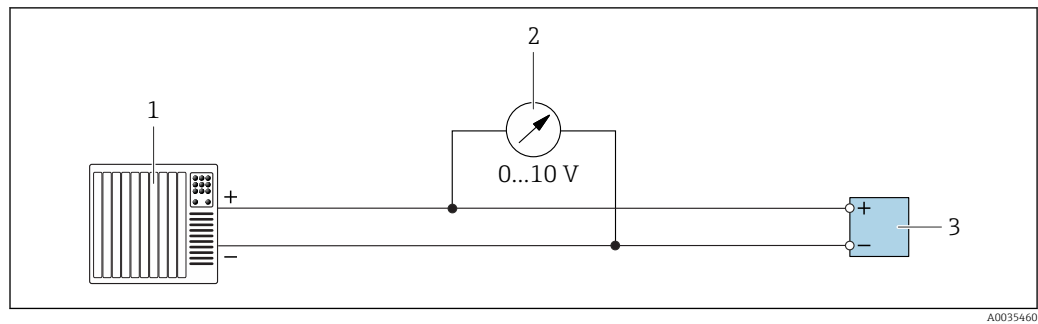

A0035460

3 Connection example for voltage output, active, 0 to 10 V

- 1 Automation system with current or voltage input (e.g. PLC)
- 2 Analog display unit for voltage: minimum load 750 Ω
- 3 Transmitter

Relay output

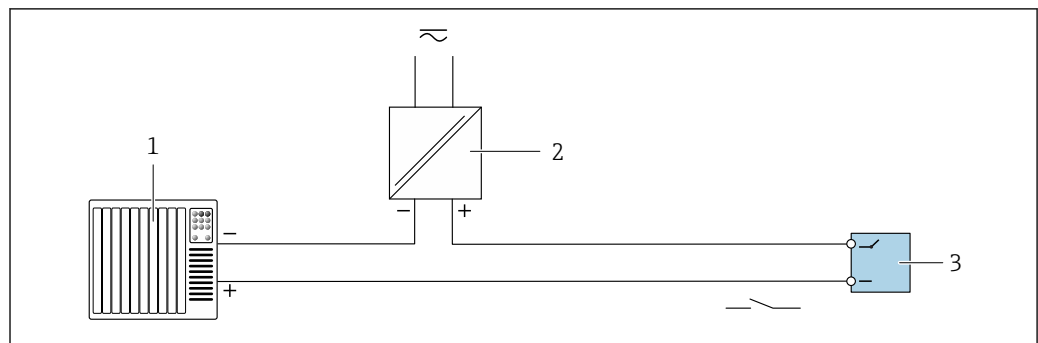

A0035461

4 Connection example for relay output, passive

- 1 Automation system with switch input (e.g. PLC)
- 2 Power supply: max. 50 V AC/DC
- 3 Transmitter

Digital input (elective inputs)

The digital input can create up to four measured variables on the analog output.

Configuration options:

Active analog output	Digital input "0"	Digital input "1"
Channel 1	Open	Open
Channel 2	Ground	Open
Channel 3	Open	Ground
Channel 4	Ground	Ground

**NOTICE**

**Interference at the digital input**

If the device is connected incorrectly, this impacts the functional integrity of the measuring device.

- ▶ If the digital input is used, connect digital inputs "0" and "1" to signal ground.

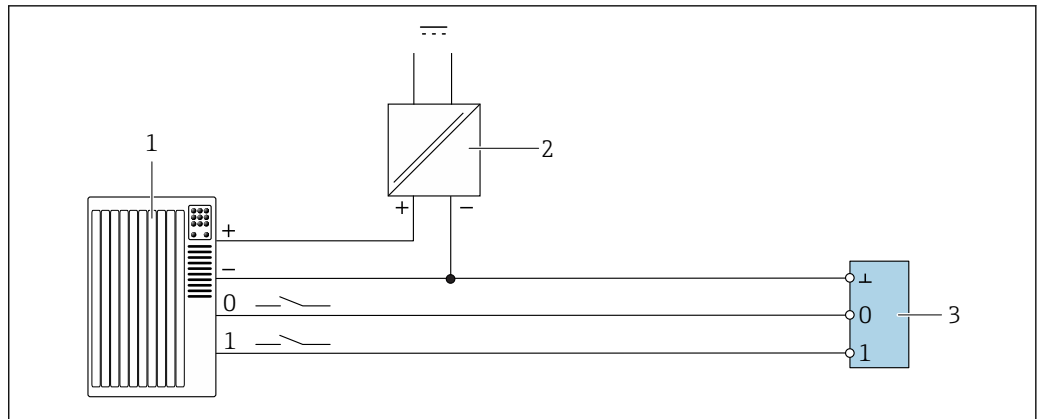

A0035462

- 5 Connection example for the digital input
- 1 Automation system with switch input (e.g. PLC)
  - 2 Power supply
  - 3 Transmitter

**i** If the transmitter is connected as illustrated in the example, the outputs are no longer galvanically isolated.

**Potential equalization**

The measuring device must be included in the potential equalization. The transmitter and sensor are connected to the same potential via the connecting cable. This potential must be current-free.

**i** Terminal V- is electrically connected to the transmitter housing and can be used for potential equalization.

**Terminals**

<b>Terminal type</b>	Screw terminals
<b>Conductor cross-section</b>	0.129 to 1.31 mm <sup>2</sup> (16 to 26 AWG)

**Cable specification**

**Permitted temperature range**

- Comply with the installation guidelines and regulations that apply in the country of installation.
- The cables must be suitable for the expected minimum and maximum temperatures.

**Connecting cable between sensor and transmitter**

Only use the cable supplied.

**Modbus Ethernet cable**

<b>Cable type</b>	100 Base-TX
<b>Cable category</b>	Min. CAT5
<b>Plug type</b>	RJ-45 (8P8C)
<b>Shielding</b>	S/FTP, F/FTP, SF/FTP, S/UTP, F/UTP or SF/UTP
<b>Cable length</b>	Max. 30 m (98 ft)

**Power supply and signal cables**

<b>Cable type</b>	Strand or solid wire
<b>Conductor cross-section</b>	0.129 to 1.31 mm <sup>2</sup> (16 to 26 AWG)
<b>Temperature range</b>	<ul style="list-style-type: none"> <li>▪ -40 to 70 °C (-40 to +158 °F) when mounted in a fixed position</li> <li>▪ -10 to 50 °C (+14 to +122 °F) when cable can move freely</li> </ul>
<b>Cable length</b>	Max. 30 m (98 ft)

Power supply cable	Standard installation cable is sufficient
Analog output	
Digital input	
Relay output (alarm)	

#### Requirements for the supply unit

Supply voltage	DC 24 V(nominal voltage: DC 18 to 35 V)
Power unit	The power unit must be tested to ensure it meets safety requirements (e.g. PELV, SELV).

## Performance characteristics

Max. measured error	Speed of sound	$\pm 2$ m/s ( $\pm 6.56$ ft/s)
	Temperature	$\pm 0.5$ K
	Density	$\pm 0.01$ g/cm <sup>3</sup>

#### Accuracy

#### Accuracy of concentration measurement

The measuring device can achieve an accuracy of up to 0.01 %. The accuracy depends on the concentration app. Detailed information on the accuracy is provided in the data sheet.

#### Reaction time

#### Influence of medium temperature

The response time of the temperature measurement depends on the heat transfer from the fluid to the steel. Activation of the Kalman filter accelerates the response time. An erratic change in the temperature generates an error message. It is possible to set a threshold for displaying the error.

#### Influence of variations in the fluid temperature

If the fluid temperature changes quickly ( $>1.5$  °C/min ( $34.7$  °F/min)), the measured error can be greater than specified in the "Max. measured error" section.

#### Influence of vibrations

The measured error can be greater than specified in the "Max. measured error" section as a result of mechanical or acoustic vibrations in the 0.8 to 2.0 MHz range.

#### Influence of ambient temperature

#### Current/voltage output

Temperature coefficient	$100 \mu\text{V}/^\circ\text{C}$ ( $\mu\text{V}/^\circ\text{F}$ ) or $\pm 1 \mu\text{A}/^\circ\text{C}$ ( $\mu\text{A}/^\circ\text{F}$ )
-------------------------	--

#### Influence of air bubbles

Air bubbles and particles are disturbance factors when measuring with acoustic surface waves. The recommended installation positions and the "Dispersion" diagnostic information largely prevent incorrect measurement results caused by air bubbles or particles.

## Installation

### Mounting location

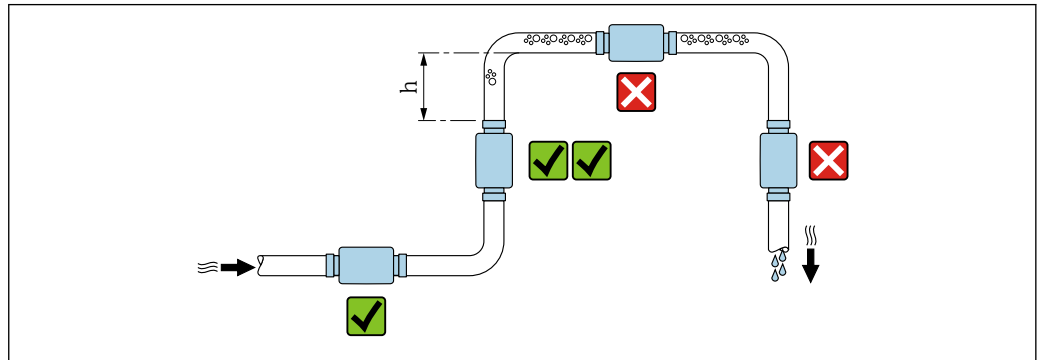

A0032998

6 Mounting location

Ideally, the sensor should be installed in an ascending pipe, while ensuring a sufficient distance is kept to the next pipe elbow:  $h \geq 5 \times DN$ .

### Orientation Teqwave I

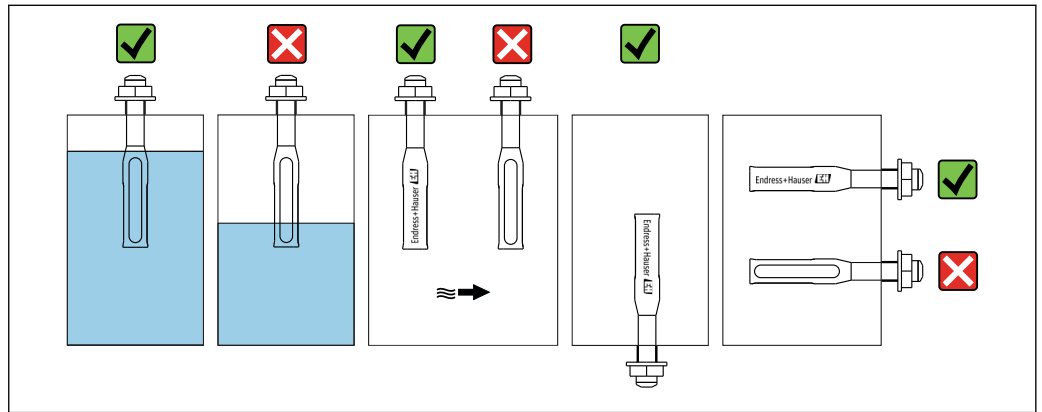

A0035457

7 Orientation of Teqwave I

Mount Teqwave I so that the active sensor area can be fully immersed in the measured liquid.

If installing the sensor in a pipe, make sure the sensor is aligned correctly to avoid irregular flow to the sensor. Rotate the sensor so that the dot on the process connection is aligned with the flow direction.

If installing the sensor in a horizontal position, make sure the sensor is aligned correctly to avoid the buildup of deposits around the sensing element. Rotate the sensor so that the black dot on the process connection points up or down.

#### NOTICE

#### Measurement result is not representative

Heterogeneous mixing of the fluid and irregular flow to the sensor can distort the measurement results, which are only valid for the layer of liquid in which the sensor is located.

- Ensure the homogeneous mixing of the liquid and continuous flow of liquid to the sensor.

### Inlet and outlet runs

Observe the following inlet and outlet runs to comply with accuracy specifications:

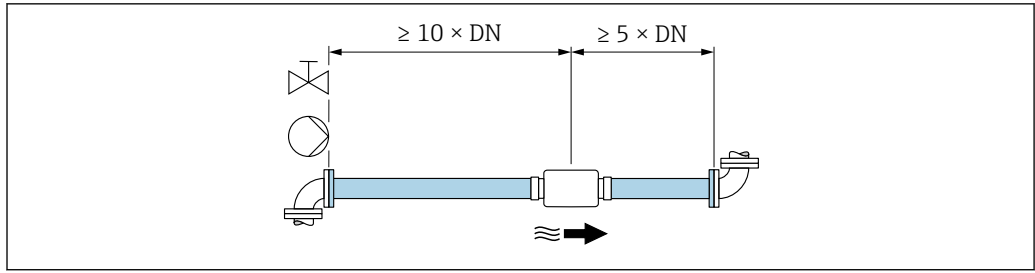

A0035458

8 Inlet and outlet runs

Installing the transmitter

DIN rail mounting

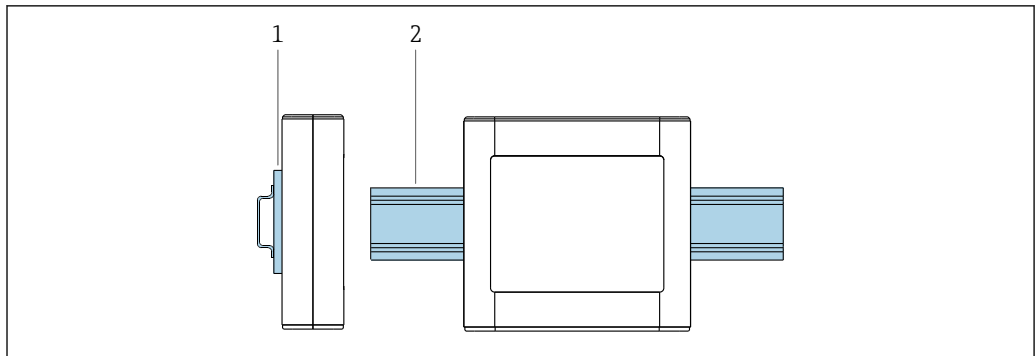

A0035459

9 DIN rail mounting

- 1 DIN rail holder
- 2 DIN rail according to DIN EN 60715 TH 35

## Environment

Ambient temperature range	Sensor	0 to +50 °C (+32 to +122 °F)
	Transmitter	0 to +50 °C (+32 to +122 °F)

Storage temperature 0 to +50 °C (+32 to +122 °F)

Degree of protection	Sensor	IP 68 with cable plugged in
	Transmitter	IP 40

Electromagnetic compatibility (EMC)

- As per IEC/EN 61326-1
- Complies with emission limit for industry as per EN 55011 (Class A)

For details, refer to the Declaration of Conformity.

## Process

Medium temperature range Sensor  
0 to +100 °C (+32 to +212 °F)

Nominal pressure Sensor  
Max. 16 bar (232 psi) at 20 °C (68 °F)



**Flow velocity**

Max. 5 m/s (16.4 ft/s).

## Mechanical construction

**Design dimensions**

**Transmitter**

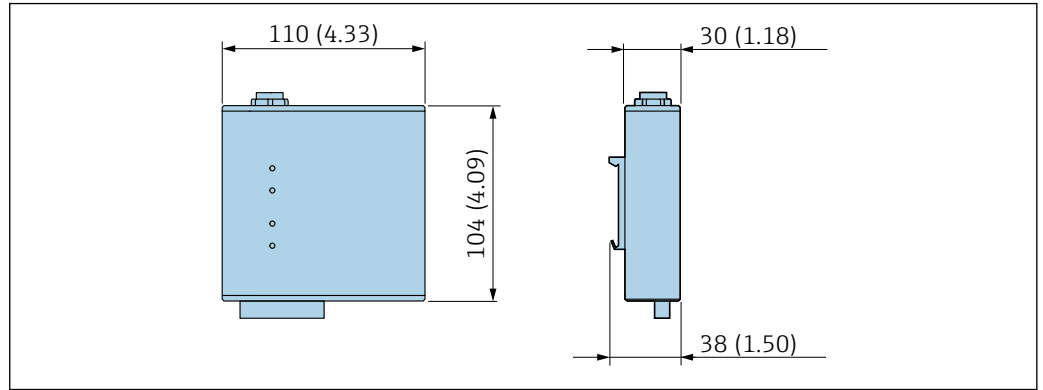

A0035716

10 Dimensions in mm (in)

**"Teqwave F" sensor, internal and external thread**

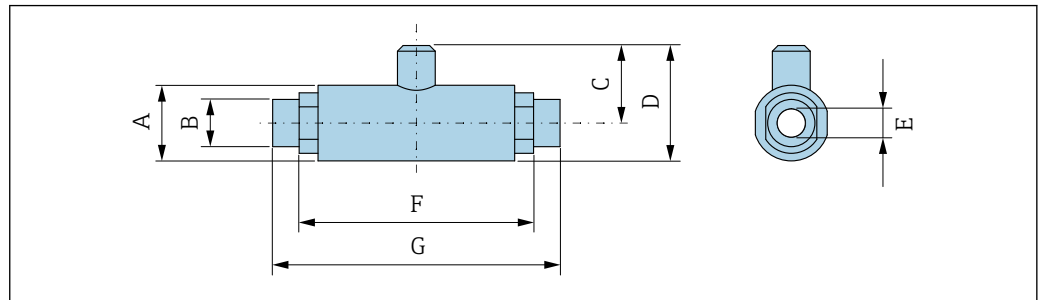

A0035717

*Dimensions in SI units*

DN [mm]	A [mm]	B	C [mm]	D [mm]	E [mm]	F [mm]	G [mm]
8	35	G 1/4"	38	55.5	8	106	130
15	40	G 1/2"	41	61	15	124	152
25	54	G 1"	48	75	25	160	210

*Dimensions in US units*

DN [in]	A [in]	B	C [in]	D [in]	E [in]	F [in]	G [in]
3/8	1.38	G 1/4"	1.50	2.19	0.31	4.17	5.12
1/2	1.57	G 1/2"	1.61	2.40	0.59	4.88	5.98
1	2.13	G 1"	1.89	2.95	0.98	6.30	8.27

"Teqwave F" sensor, flange

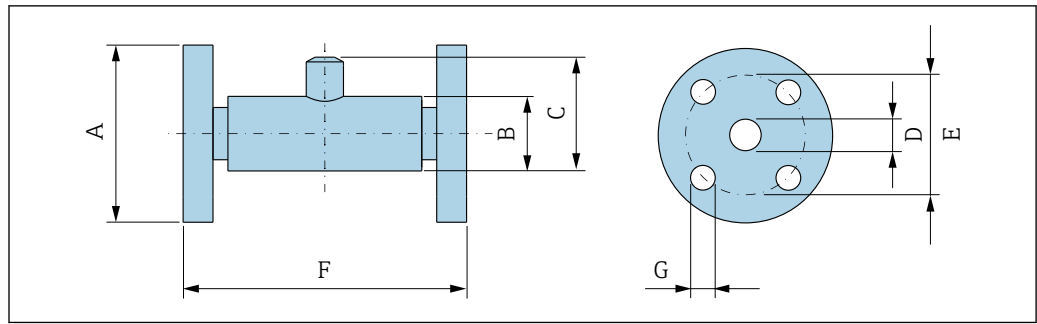

A0035718

Dimensions in SI units

DN [mm]	A [mm]	B [mm]	C [mm]	D [mm]	E [mm]	F [mm]	G [mm]
8	95	35	56	8	65	134	14
15	95	40	61	15	65	152	14
25	115	54	75	25	85	192	14

Dimensions in US units

DN [in]	A [in]	B [in]	C [in]	D [in]	E [in]	F [in]	G [in]
$\frac{3}{8}$	3.74	1.38	2.20	0.31	2.56	5.28	0.55
$\frac{1}{2}$	3.74	1.57	2.40	0.59	2.56	5.98	0.55
1	4.53	2.13	2.95	0.98	3.35	7.56	0.55

"Teqwave I" sensor, external thread

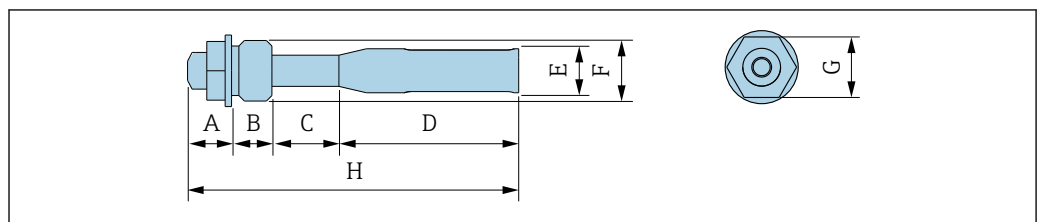

A0035719

Dimensions in SI units

Installed length [mm]	A [mm]	B [mm]	C [mm]	D [mm]	E [mm]	F	G [mm]	H [mm]
180	24	22	36.5	98.0	24	G 1"	32	180.5
500	24	22	362.5	98	24	G 1"	32	506.5

Dimensions in US units

Installed length [in]	A [in]	B [in]	C [in]	D [in]	E [in]	F	G [in]	H [in]
7	0.94	0.87	1.44	3.86	0.94	G 1"	1.26	7.11
20	0.94	0.87	14.3	3.86	0.94	G 1"	1.26	19.94

"Teqwave I" sensor, flange

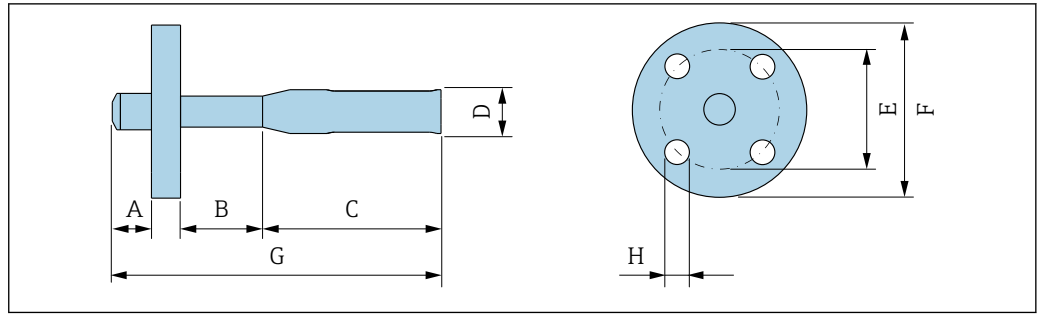

A0035720

Dimensions in SI units

Installed length [mm]	A [mm]	B [mm]	C [mm]	D [mm]	E [mm]	F [mm]	G [mm]	H [mm]
180	21.5	48	98	24	85	115	180	14
500	21.5	371	98	24	85	115	506	14

Dimensions in US units

Installed length [in]	A [in]	B [in]	C [in]	D [in]	E [in]	F [in]	G [in]	H [in]
7	0.85	1.77	3.86	0.94	3.35	4.53	7.11	0.55
20	0.85	14.6	3.86	0.94	3.35	4.53	19.94	0.55

Weight

Transmitter

Weight of transmitter	0.34 kg (0.8 lb)
-----------------------	------------------

"Teqwave F" sensor

DN [mm (in)]	Flange [kg (lb)]	External thread [kg (lb)]	Internal thread [kg (lb)]
8 (3/8")	1.85 (4.08)	0.45 (0.99)	0.45 (0.99)
15 (1/2")	2.0 (4.4)	0.6 (1.3)	0.6 (1.3)
25 (1")	4.0 (8.8)	1.4 (3.1)	1.4 (3.1)

"Teqwave I" sensor

Installed length [mm (in)]	Flange [kg (lb)]	External thread [kg (lb)]
180 (7") Order code for "Insertion Length, Insertion Tube Material", option AS	1.52 (3.35)	0.42 (0.93)
500 (20") Order code for "Insertion Length, Insertion Tube Material", option BS	1.70 (3.75)	0.61 (1.35)

Materials

Transmitter housing

Housing	Anodized aluminum
Window material	Glass plate
Terminal connection	Polybuteneterephthalate (PBT)

<b>Ethernet interface</b>	<ul style="list-style-type: none"> <li>▪ Socket: ferrite</li> <li>▪ Contact housing: thermoplastic</li> <li>▪ Contacts: 100 % tin with nickel coating, gold-plated</li> </ul>
<b>Push-pull connection</b>	<ul style="list-style-type: none"> <li>▪ Socket: brass, nickel-plated</li> <li>▪ Contact housing: polyetheretherketone (PEEK)</li> <li>▪ Contacts: brass, gold-plated</li> </ul>

### Sensor housing



Stainless steel, 1.4571 (V4A) / 316Ti

### Connecting cable

<b>Cable, external material</b>	Polyurethane as per DIN EN 60811-2-1 (oil-resistant, halogen-free)
<b>Connector</b>	<ul style="list-style-type: none"> <li>▪ Socket: brass, nickel-plated</li> <li>▪ Contact housing: polyetheretherketone (PEEK)</li> <li>▪ Contacts: brass, gold-plated</li> </ul>

### Process connections

#### "Teqwave F" sensor

- Flange, EN 1092-1 (DIN 2501), PN 16
- External thread →  17
- Internal thread →  17

#### "Teqwave I" sensor

- Flange, EN 1092-1 (DIN 2501), PN 16
- External thread →  18

## Operability

### Local operation

#### Via display module

Two display modules are available:

- Order code for "Display, operation", option A "LED status indication"
- Order code for "Display, operation", option B "3.5" TFT touch display"

### Supported operating tools

Operation via "Teqwave Viewer" Windows Desktop operating tool.

### Reliable operation

If the power supply fails, data saved in the device and device configurations are retained.

### Languages

Can be operated in the following languages:

- Via local operation (transmitter with touch screen):  
English, German, French, Spanish, Italian
- Via operating tool:  
English, German, French, Spanish, Italian

## Certificates and approvals

### CE mark

The device meets the legal requirements of the applicable EU Directives. These are listed in the corresponding EU Declaration of Conformity along with the standards applied.

Endress+Hauser confirms successful testing of the device by affixing to it the CE mark.

### RCM-tick symbol

The measuring system meets the EMC requirements of the "Australian Communications and Media Authority (ACMA)".

## Other standards and guidelines

- EN 60529  
Degrees of protection provided by enclosures (IP code)
- EN 61010-1  
Safety requirements for electrical equipment for measurement, control and laboratory use - general requirements
- IEC/EN 61326-1  
Electromagnetic compatibility (EMC requirements)
- RoHS and EN 50581  
Restriction of hazardous substances in electric and electronic devices.

## Ordering information

Detailed ordering information is available as follows:

- In the Product Configurator on the Endress+Hauser website: [www.endress.com](http://www.endress.com) -> Click "Corporate" -> Select your country -> Click "Products" -> Select the product using the filters and search field -> Open product page -> The "Configure" button to the right of the product image opens the Product Configurator.
- From your Endress+Hauser Sales Center: [www.addresses.endress.com](http://www.addresses.endress.com)



### Product Configurator - the tool for individual product configuration

- Up-to-the-minute configuration data
- Depending on the device: Direct input of measuring point-specific information such as measuring range or operating language
- Automatic verification of exclusion criteria
- Automatic creation of the order code and its breakdown in PDF or Excel output format
- Ability to order directly in the Endress+Hauser Online Shop

## Application packages

Application packages are available for the device to expand the device functions, depending on user needs. The application packages can be ordered with the device or subsequently from Endress+Hauser. The Endress+Hauser Sales Center can provide detailed information on the relevant order code. The product page on the Endress+Hauser website [www.endress.com](http://www.endress.com) also contains additional information on the order code.

Package	Description
Viewer with interface for data download	<b>Retrieval and storage of measured values.</b> The application package allows users to retrieve measured data saved in the internal device memory. In addition, the measured data can be saved in a text file which can be imported into a database. Order number: DK9501

## Accessories

Various accessories, which can be ordered with the device or subsequently from Endress+Hauser, are available for the device. Detailed information on the order code in question is available from your local Endress+Hauser sales center or on the product page of the Endress+Hauser website: [www.endress.com](http://www.endress.com).

## Device-specific accessories

## About the transmitter

Accessories	Description
<b>Transmitter</b> <ul style="list-style-type: none"> <li>▪ LED status indication</li> <li>▪ Touch screen</li> </ul>	<b>Transmitter for replacement or storage.</b> The serial number of the current transmitter must be specified when ordering. On the basis of the serial number, device-specific data in the replaced device can also be used in the new transmitter. Order number: DK9BXX
<b>Connecting cable between sensor and transmitter</b>	The following cable lengths are available (order code for "Cable, sensor connection"): <ul style="list-style-type: none"> <li>▪ Option B: 1 m (3 ft)</li> <li>▪ Option D: 2 m (6 ft)</li> <li>▪ Option E: 5 m (15 ft)</li> <li>▪ Option F: 10 m (30 ft)</li> </ul> Order number: XPD0047

## Communication specific accessories

Accessories	Description
<b>Concentration app</b>	<b>Data record for integrating new fluids into the measuring device.</b> The concentration apps are available on the CD-ROM. A list of the available concentration apps and measuring ranges is provided in the Applicator → 22. If you require a concentration app that is not already listed in the Applicator, Endress+Hauser requires a sample of the fluid to create the concentration app. Endress+Hauser provides the concentration app as a file in lmf format. Every transmitter can use a maximum of 25 concentration apps. Order number: DK9500

## Service-specific accessories

Accessories	Description
Applicator	Software for selecting and sizing Endress+Hauser measuring devices: <ul style="list-style-type: none"> <li>▪ Choice of measuring devices for industrial requirements</li> <li>▪ Calculation of all the necessary data for identifying the optimum flowmeter: e.g. nominal diameter, pressure loss, flow velocity and accuracy.</li> <li>▪ Graphic illustration of the calculation results</li> <li>▪ Determination of the partial order code, administration, documentation and access to all project-related data and parameters over the entire life cycle of a project.</li> </ul> Applicator is available: <ul style="list-style-type: none"> <li>▪ Via the Internet: <a href="https://portal.endress.com/webapp/applicator">https://portal.endress.com/webapp/applicator</a></li> <li>▪ As a downloadable DVD for local PC installation.</li> </ul>
W@M	<b>W@M Life Cycle Management</b> Improved productivity with information at your fingertips. Data relevant to a plant and its components is generated from the first stages of planning and during the asset's complete life cycle. W@M Life Cycle Management is an open and flexible information platform with online and on-site tools. Instant access for your staff to current, in-depth data shortens your plant's engineering time, speeds up procurement processes and increases plant uptime. Combined with the right services, W@M Life Cycle Management boosts productivity in every phase. For more information, visit <a href="http://www.endress.com/lifecyclemanagement">www.endress.com/lifecyclemanagement</a>

## Documentation

-  For an overview of the scope of the associated Technical Documentation, refer to the following:
- *W@M Device Viewer* ([www.endress.com/deviceviewer](http://www.endress.com/deviceviewer)): Enter the serial number from nameplate
  - *Endress+Hauser Operations App*: Enter the serial number from the nameplate or scan the 2D matrix code (QR code) on the nameplate

**Standard documentation**

Document type	Documentation code
Operating Instructions	BA01823D
Brief Operating Instructions	KA01371D

## Registered trademarks

**Modbus®**

Registered trademark of SCHNEIDER AUTOMATION, INC.

**Microsoft®**

Registered trademark of the Microsoft Corporation, Redmond, Washington, USA

[www.addresses.endress.com](http://www.addresses.endress.com)

---