

Technical Information

Connect Sensor FXA30, FXA30B

Fieldgate



Low-power cellular sensor gateway for wireless drop-in networking to remotely monitor industrial environments and control systems

Application

Battery-powered remote cellular monitoring of connected 4 to 20 mA analog as well as digital field devices via mobile communications.

- Remote monitoring and visualization of any process variable measured in the field regardless of location
- Especially great for controlling the inventory in typical 3-times-a-day measuring
- Flexible for battery use on remote places or powered by DC
- Configuration of measuring and transmission cycles
- Four 4 to 20 mA input channels, one digital input for wake up special condition
- Modbus RS485 input for up to 4 slaves (FXA30B)

Your benefits









- Simple configuration of Fieldgate via Machine-to-Machine communication service from Endress+Hauser
- Specially useful for remote locations due to a long-lasting battery
- External, configurable power outputs eliminate the need for sensor power supplies
- Weatherproof enclosure with wide temperature range makes it ideal for use in all environments
- Configurable read and uplink intervals
- LTE (USA, Canada and Mexico only) or 3G penta band cellular module for global communication
- Optional available with bundled cellular service

Table of contents



Important document information	3	Supplementary documentation	20
Symbols for certain types of information	3	Standard documentation	20
Symbols in graphics	3		
Terms and abbreviations	4		
Registered trademarks	5		
Function and system design	5		
Use cases	6		
Point to point remote monitoring	6		
Up to 4 × point to point remote monitoring	7		
Input	8		
Analog	8		
Digital	8		
Output	9		
Digital output	9		
Power output	9		
Power supply	10		
Power options	10		
Installation	11		
Mounting	11		
Antenna	12		
Environment	13		
Mechanical construction	14		
Dimensions	14		
Weight	14		
Materials	14		
Operability	15		
Operating concept	15		
Certifications	15		
RF exposure statement	15		
FCC certifications and regulatory information	15		
UL/cUL conformity	16		
Product marking	16		
Ordering information	17		
Connect Sensor FXA30	17		
Connect Sensor FXA30B	18		
XD87DC – FXA30 Data communication service	18		
Accessories	19		

Important document information

Symbols for certain types of information

Symbol	Meaning
	Permitted Procedures, processes or actions that are permitted.
	Preferred Procedures, processes or actions that are preferred.
	Forbidden Procedures, processes or actions that are forbidden.
	Tip Indicates additional information.
	Reference to documentation.
	Reference to page.
	Reference to graphic.
	Visual inspection.

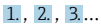
Symbols in graphics

Symbol	Meaning	Symbol	Meaning
1, 2, 3,...	Item numbers		Series of steps
A, B, C, ...	Views	A-A, B-B, C-C, ...	Sections
	Hazardous area		Safe area (non-hazardous area)

Terms and abbreviations

Term/abbreviation	Explanation
BA	Document type "Operating Instructions"
KA	Document type "Brief Operating Instructions"
TI	Document type "Technical Information"
SD	Document type "Special Documentation"
XA	Document type "Safety Instructions"
FIS	Field Information Server A web-based operating portal for managing the lifecycle & diagnostics of worldwide applied gateways in the Inventory Management System.
SupplyCare Hosting	Cloud-based inventory management platform for transparent information within the supply chain
APN	Access Point Name
CLI	Command Line Interface
DHCP	Dynamic Host Configuration Protocol
IMEI	International Mobile Equipment Identity
LED	Light Emitting Diode
TCP	Transmission Control Protocol
USB	Universal Serial Bus
URL	Uniform Resource Locator

Registered trademarks

DIGI®

Digi, Digi International, and the Digi logo are trademarks or registered trademarks in the United States and other countries worldwide of Digi International Inc.

Modbus™

Registered trademark of Schneider Electric USA, Inc.

Internet Explorer 11

Registered trademark of the MICROSOFT CORPORATION.

Firefox®

Registered trademark of the Mozilla Foundation

Chrome™

Registered trademark of Google Inc.

All other trademarks mentioned in this document are the property of their respective owners.

Function and system design

Connect Sensor FXA30/FXA30B is a low-power cellular sensor gateway for wireless drop-in networking to remotely monitor industrial environments and control systems, such as inventory level, flow, pressure as well as any other process variable. To power Connect Sensor FXA30/FXA30B, use either the internal battery or an external power source, such as solar panels, for setups with no power or limited power. Connect Sensor FXA30/FXA30B includes an external input/output (I/O) interface inside a waterproof enclosure for connecting sensors. The sensors gather information (sensor readings) from their environment, and Connect Sensor FXA30/FXA30B reports that information to SupplyCare Hosting using a lowbandwidth cellular connection.

-  Make sure there is adequate cellular network coverage where you plan to install the gateway before purchasing cellular service.

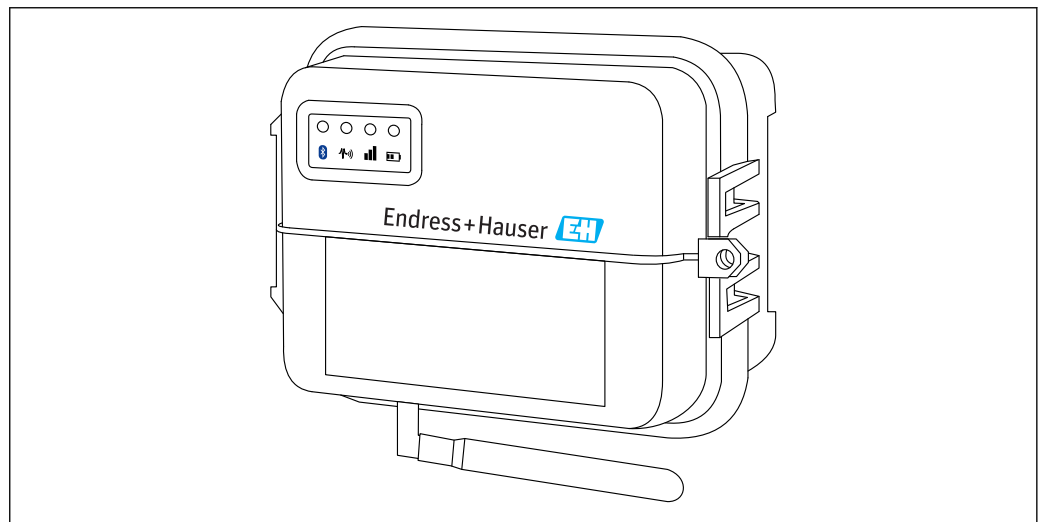

A0033474

Use cases

Point to point remote monitoring

Connect Sensor FXA30/FXA30B (battery and/or mains powered) can connect 1 sensor to SupplyCare Hosting using 4 to 20 mA analogue communication.

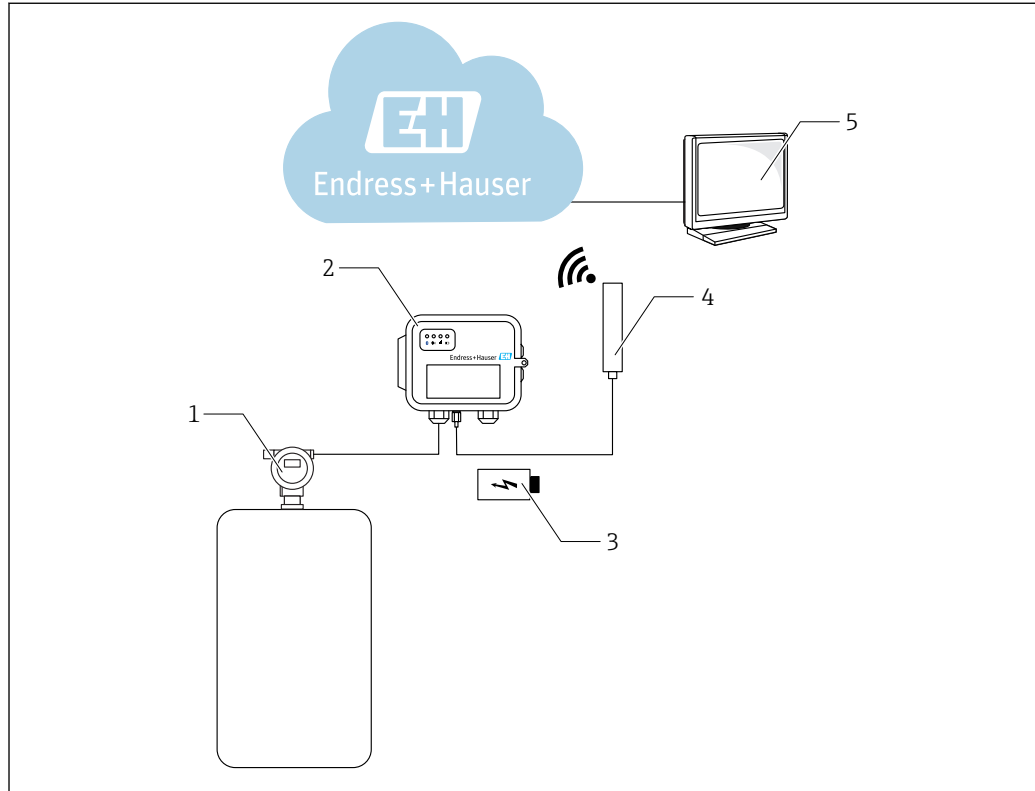

A0034527

- 1 Sensor
- 2 Connect Sensor FXA30/FXA30B
- 3 Battery and/or mains power
- 4 Antenna
- 5 SupplyCare Hosting

Up to 4 × point to point remote monitoring

Connect Sensor FXA30/FXA30B (battery and/or mains powered) can connect up to 4 sensors to SupplyCare Hosting using 4 × 4 to 20 mA analogue communication.

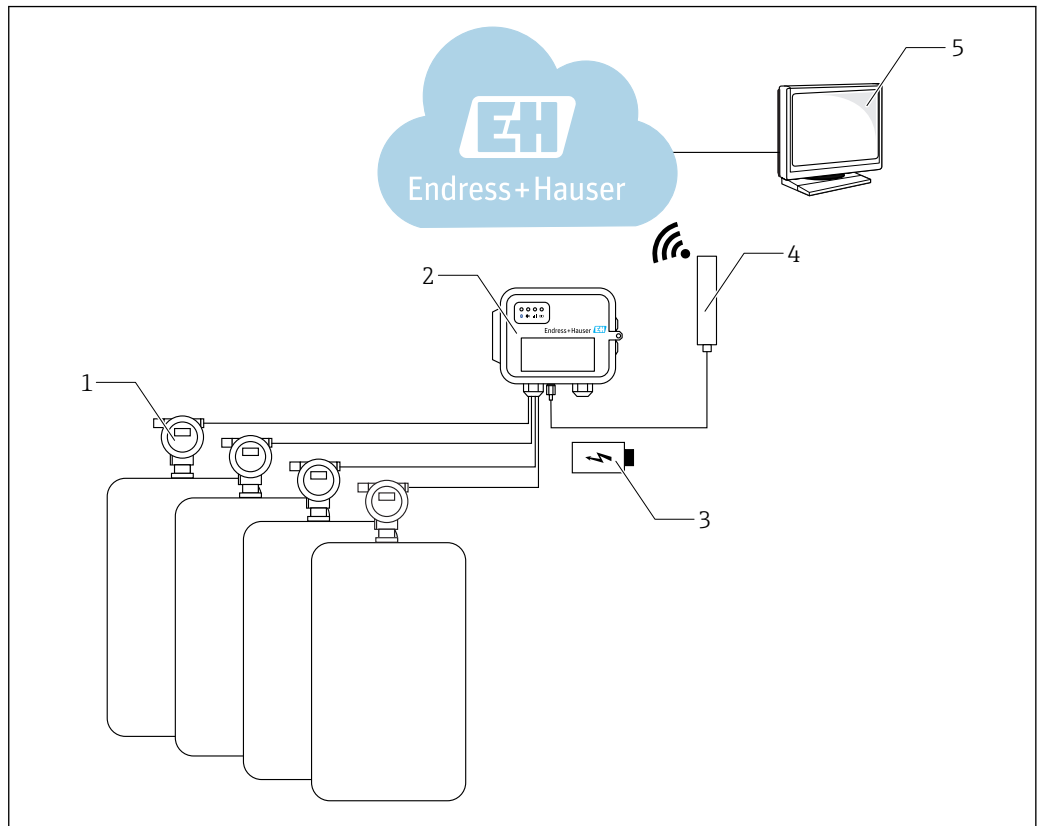

A0034528

- 1 Sensor
- 2 Connect Sensor FXA30/FXA30B
- 3 Battery and/or mains power
- 4 Antenna
- 5 SupplyCare Hosting

Input

Analog

Current loop

Connect Sensor FXA30/FXA30B can monitor a current input from 4 to 20 mA from up to 4 devices.

Current range: 4 to 22 mA (Current loop input)

Modbus RS-485 - Connect Sensor FXA30B

Connect Sensor FXA30B can monitor up to 4 Modbus-enabled external sensors.

Biasing and termination are needed when a Modbus sensor is connected on a long wiring harness and the sensor does not provide its own termination and biasing. Termination is only applied at the two ends of the 485 bus (not in the middle), and bias typically is applied only once on the whole bus.

For detailed information about implementing Modbus over a serial line, refer to the Modbus documentation at www.modbus.org.

Digital

When configuring the digital I/O pin as a digital input, it allows the following modes of operation:

Input mode

Connect Sensor FXA30/FXA30B gets the digital input value at scheduled sensor readings. You can configure it to send an alarm report for specific input values or when an input value changes. You can also configure Connect Sensor FXA30/FXA30B to wake from sleep mode when an input value changes (rising edge or falling edge wake).

Input Range:

- 0 to 0.6 V_{DC} logic low
- 2.2 to 30 V_{DC} logic high



Max. input voltage 30 V_{DC}

Pulse counter

Connected to a mechanical meter, Connect Sensor FXA30/FXA30B counts pulses during Connect Sensor FXA30/FXA30B sleep cycles and reports them to SupplyCare Hosting during normal reporting intervals.

Max. pulse count frequency 2 kHz

Output

Digital output

When configuring the digital I/O pin as a digital output, it is an open collector output with an optional pull-up resistor. A self-resetting fuse limits the maximum collector current to 750 mA.

Power output

Connect Sensor FXA30/FXA30B can power up to 4 sensors using the analog, digital, or serial power outputs.

- The sensor power output voltage is 24 V_{DC}
- The maximum output current for each sensor power output connector is 200 mA.



When using continuous monitoring, the combined maximum output current for ALL sensors is 200 mA.

Power supply

Power options

Power the Connect Sensor FXA30/FXA30B

While Connect Sensor FXA30/FXA30B has an internal battery for power, you can use an external power source, such as solar panels or other DC sources. For an external power source, use the external power input to power the Connect Sensor FXA30/FXA30B device.

-  When Connect Sensor FXA30/FXA30B is connected to an external power source, the external power source becomes the primary power source and the internal battery becomes a backup power source.
If the external power source is unable to power Connect Sensor FXA30/FXA30B (such as when it has an unacceptable voltage range), it automatically switches to the internal battery as the power source.
- The external power inputs accept a DC range of 8 to 30 V_{DC}

Power the sensors

The Connect Sensor FXA30/FXA30B can power sensors connected to the analog, digital, or serial power outputs. In order to configure the Connect Sensor FXA30/FXA30B power options the cloud interface on the Field Information Server is to be used.

-  If you have a Modbus-enabled device that must get power from the Connect Sensor FXA30B, the Modbus device must be wired to the serial power output.

Note the following:

- The sensor power output voltage is 24 V_{DC}
- The maximum output current for each sensor power output connector is 200 mA

Installation

Mounting

Wall mounting

1. Use Mounting kit Connect Sensor FXA30/FXA30B and fix the 4 brackets with the supplied screws on backside of the housing.

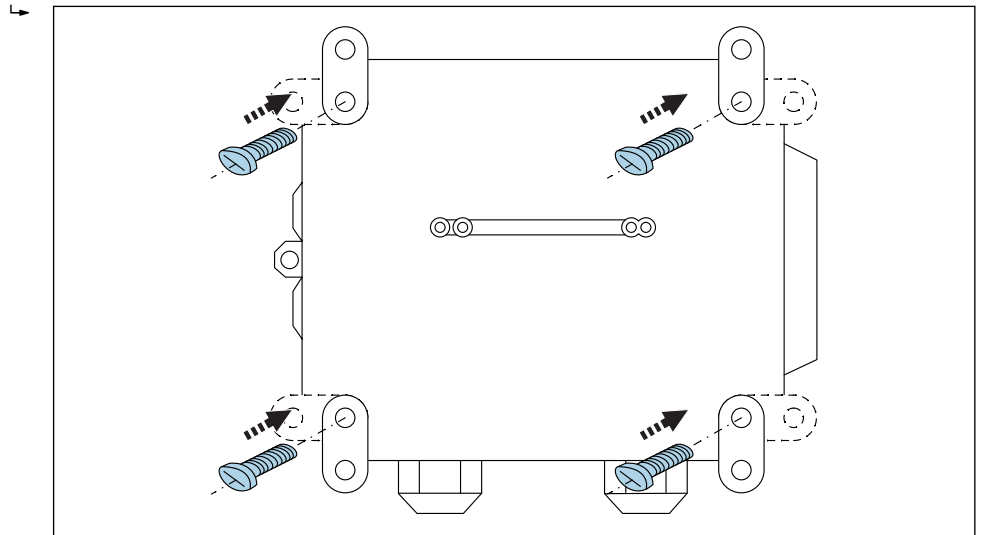

1 Backside

The Mounting kit Connect Sensor FXA30/FXA30B can be ordered as accessory via Order code : 71336975

2. Only to be fastened at stable materials (e.g. metal, brick, concrete) using suitable fastening material (to be supplied by customer).

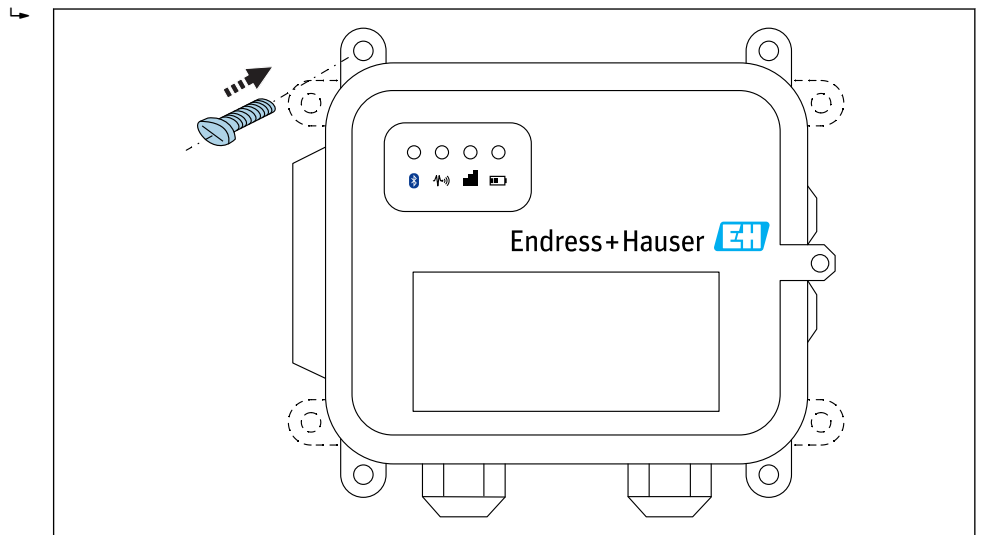

2 Frontside

Antenna

Connect Sensor FXA30/FXA30B require an external antenna for wireless communication via UMTS (2G/3G) or LTE (North America).

If Connect Sensor FXA30/FXA30B is mounted inside a cabinet, the antenna must be mounted outside the cabinet.

Suitable antennas are available as an accessory →  19.

 In areas with weak UMTS (2G/3G) or LTE (North America) reception, it is advisable to first check the communication before securing the antenna permanently.

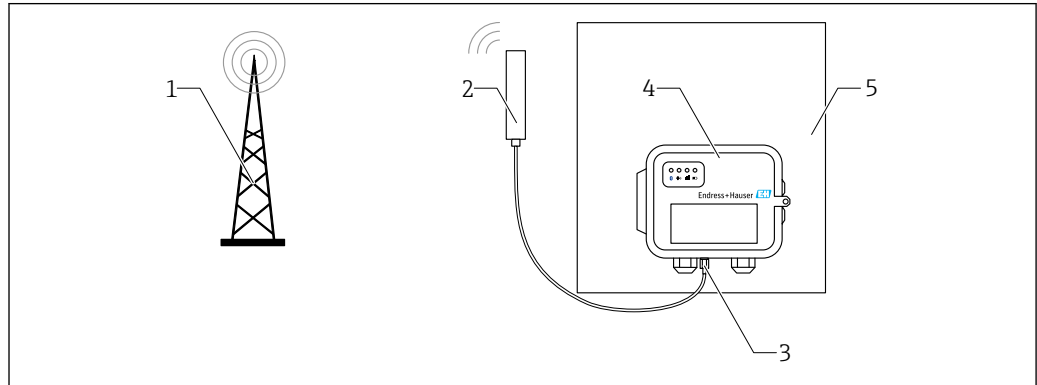

A0033580

 3 Connection: SMA connection

- 1 UMTS (2G/3G) or LTE network
- 2 Antenna for Connect Sensor FXA30/FXA30B
- 3 SMA connection
- 4 Connect Sensor FXA30/FXA30B
- 5 Control cabinet

Environment

Environmental Operating temperature	-35 to +70 °C (-31 to 158 °F)
Storage temperature	-40 to +85 °C (-40 to 185 °F)
Relative humidity	90% (Non-condensing after 90%)
Ingress Protection (IP) rating	IP66

Mechanical construction

Dimensions

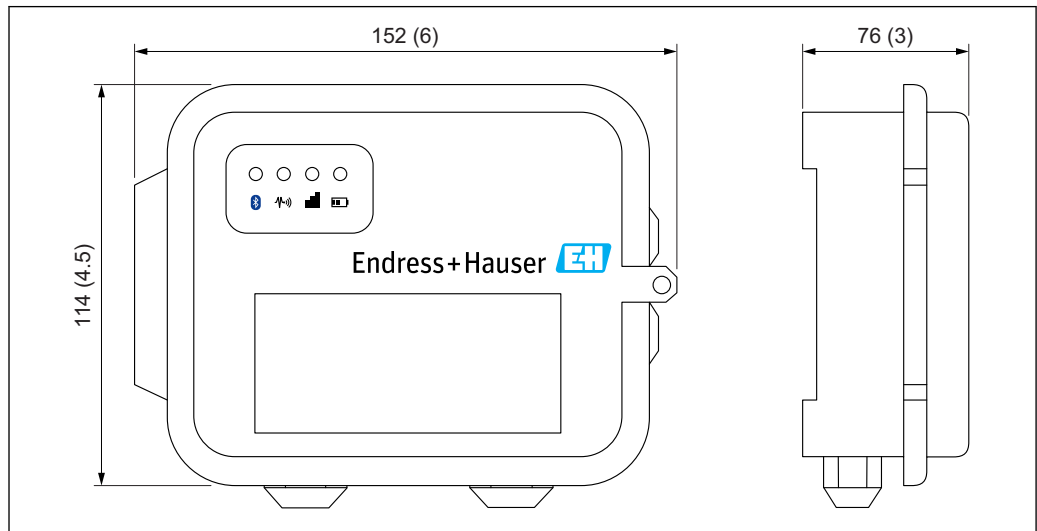

4 Dimensions in mm (in)

Weight

Part	Weight
Connect Sensor FXA30/FXA30B incl. battery, w/o antenna	0.57 kg (1.25 lb)
Battery-Lithium-thionyl chloride FXA30 Order code: 71329969	Weight: 227 g (8 oz)

Materials

Part	Material
Connect Sensor FXA30/FXA30B Enclosure	10% fiberglass reinforced polycarbonate NEMA Type 4, 4X, 6, and 6P UL 94 V-0
Battery	Lithium-thionyl chloride (Li-SOCL ₂), nonrechargeable, replaceable

Operability

Operating concept

Connect Sensor FXA30/FXA30B is a communication gateway that will exclusively work together with SupplyCare Hosting from Endress+Hauser. It is not a stand alone Gateway solution and therefore the purchase of SupplyCare Hosting visualization has to be foreseen.

Configuration and management	<ul style="list-style-type: none"> ■ Endress+Hauser Field Information Server (FIS) ■ Local USB to Serial CLI Protocol
Protocol	TCP
SIM Slots	1, standard size

Hardware enhancements

Additional to the features of the Connect Sensor FXA30 the Connect Sensor FXA30B is equipped with the following functions:

Modbus protocol (RS485 serial)

Data storage

- Standard-Firmware:
In case of problems with the uplink mobile connection, the Connect Sensor FXA30B can store the measured data of up to 63k data points.
- Continuous Monitoring Firmware:
Connect Sensor FXA30B can store 5 minutes of measured data (resolution 1 second) before and after an alarm event.

Certifications

The following certifications apply to the Connect Sensor FXA30/FXA30B device.

RF exposure statement

In order to comply with RF exposure limits established in the ANSI C95.1 standards, ensure users maintain a distance from the product of no less than 200 mm (7.87 in).

FCC certifications and regulatory information

Radio frequency interface (RFI) (FCC 15.105)

This device has been tested and found to comply with the limits for Class B digital devices pursuant to Part 15 Subpart B, of the FCC rules. These limits are designed to provide reasonable protection against frequency energy, and if not installed and used in accordance with the instruction manual, may cause harmful interference to radio communications. However, there is no guarantee that interference will not occur in a particular installation. If this equipment does cause harmful interference to radio or television reception, which can be determined by turning the equipment off and on, you are encouraged to attempt to correct the interference with one or more of the following measures:

- Reorient or relocate the receiving antenna.
- Increase the separation between the equipment and receiver.
- Connect the equipment to an outlet on a different circuit from the receiver.
- Consult the dealer or an experienced radio/TV technician for help.

Labeling requirements (FCC 15.19)

This device complies with Part 15 of FCC rules. Operation is subject to the following two conditions: (1) this device may not cause harmful interference, and (2) this device must accept any interference received, including interference that may cause undesired operation.

If the FCC ID is not visible when the unit is installed inside another device, then the outside of the device into which the module is installed must also display a label referring to the enclosed module FCC ID.

Modifications (FCC 15.21)

Changes or modifications to this equipment not expressly approved by Digi may void the user's authority to operate this equipment.

CE certifications (Europe only)

Connect Sensor FXA30/FXA30B complies with European union CE marking requirements.

UL/cUL conformity

Conformity to UL / cUL standards in the United States and Canada is in accordance with the following:

Standard	Title	Issue date
UL2054	UL Standard for Safety for Household and Commercial Batteries	October 29, 2004
UN 38.3	Recommendations on the Transport of Dangerous Goods Manual of Tests and Criteria	2009
UL60950-1	Safety Requirements for Electrical Equipment for Measurement, Control, and Laboratory Use	October 14, 2014

Product marking

The device must include the markings described in the following table.

Mark	Description
	CE mark

Ordering information

Detailed ordering information is available from the following sources:

- In the Product Configurator on the Endress+Hauser website: www.endress.com -> Click "Corporate" -> Select your country -> Click "Products" -> Select the product using the filters and search field -> Open product page -> The "Configure" button to the right of the product image opens the Product Configurator.
- From your Endress+Hauser Sales Center: www.addresses.endress.com



Product Configurator - the tool for individual product configuration

- Up-to-the-minute configuration data
- Depending on the device: Direct input of measuring point-specific information such as measuring range or operating language
- Automatic verification of exclusion criteria
- Automatic creation of the order code and its breakdown in PDF or Excel output format
- Ability to order directly in the Endress+Hauser Online Shop

Connect Sensor FXA30

Connect Sensor FXA30 is an unstructured product and each one of its options contains the included properties:

Order No.	Description
71329935	Connect Sensor FXA30, 2G/3G, battery
71329933	Connect Sensor FXA30, 2G/3G, w/o battery
71329937	Connect Sensor FXA30, 2G/3G, + contract, battery
71329939	Connect Sensor FXA30, 2G/3G, + contract, w/o battery
71329942	Connect Sensor FXA30, LTE, + contract, battery
71329945	Connect Sensor FXA30, LTE, + contract, w/o battery

Order No. explained - what is included?

Connect Sensor FXA30 with order No.	LTE Gateway (USA, Canada and Mexico only)	3G Penta band gateway for worldwide use	Battery	Antenna	Data cellular contract	SIM card Pre-installed
71329935 Connect Sensor FXA30, 2G/3G, battery						 Provided by customer
71329933 Connect Sensor FXA30, 2G/3G, w/o battery						 Provided by customer
71329937 Connect Sensor FXA30, 2G/3G, + contract, battery						
71329939 Connect Sensor FXA30, 2G/3G, + contract, w/o bat.						
71329942 Connect Sensor FXA30, LTE, + contract, battery						
71329945 Connect Sensor FXA30, LTE, + contract, w/o battery						

Connect Sensor FXA30B

Connect Sensor FXA30B is a structured product and can be ordered via Product Configurator
→  17

XD87DC – FXA30 Data communication service

Cellular Data Communication Service Agreement for Connect Sensor FXA30/FXA30B is a service level agreement to provide the data communication via cellular network for Connect Sensor FXA30/FXA30B fieldgates.

With the new fieldgate Connect Sensor FXA30/FXA30B we support the process of Inventory Control to gather data from the E+H measuring devices and forwarding it to SupplyCare Hosting.

The XD87DC – Connect Sensor FXA30/FXA30B Data communication service is the contract setup of the data communication for the Connect Sensor FXA30/FXA30B.

XD87DC – Cell. Data Communication (12 months)

Order No.	Description
XD87DC – A	LTE (Network coverage within USA, Canada and Mexico only) up to 1 MB/month - for FXA30 Mat.Nr: 71329942 and 71329945 - for FXA30B-#1B####
XD87DC – B	3G (global coverage) up to 1 MB/month - for FXA30 Mat.Nr: 71329937 and 71329939 - for FXA30B-#2C####
XD87DC – Y	Special Agreement with customer (over 1 MB/month) - for FXA30B-##D####

For order options A and B, the monthly use of data is set to 1 MB of data (Order options A and B), enough to cover the following use cases:

- 3 measurements + 1 uplink (per day)
- 3 measurements + 3 uplinks (per day)
- 24 measurements + 3 uplinks (per day)

For customers that need more frequent uplinks than the mentioned above the Y option can be used on request.



Before ordering a bundled data communication service or if there are any doubts on the coverage or the cellular network footprint, please always check before ordering. Detailed ordering information is available from your Endress+Hauser Sales Center:

www.addresses.endress.com

Accessories

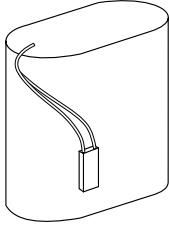
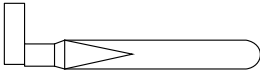
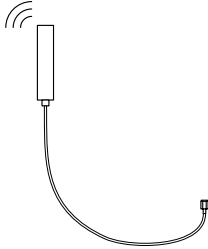
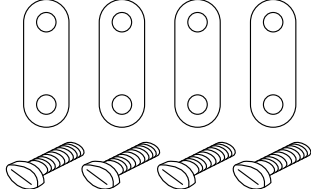
Accessory	Description
<p>Battery-Lithium-thionyl-chloride FXA30</p> 	<ul style="list-style-type: none"> ▪ Material: Lithium-thionyl chloride (Li-SOCL2) ▪ Type: ER34615 7,2V 14Ah ▪ Non-rechargeable ▪ Hazards Id. UN38.3 ▪ Weight: 227 g (8 oz) ▪ Connector cable <p>i Batteries are considered hazardous goods and may be charged by import taxes depending on the country of delivery.</p> <p>Order code: 71329969</p>
<p>Cellular antenna FXA30, 3G/4G/LTE, Swivel</p> 	<p>Usage: FXA30 with LTE or GSM</p> <ul style="list-style-type: none"> ▪ Frequencies: <ul style="list-style-type: none"> - 698 to 960 MHz - 1710 to 2170 MHz - 2500 to 2700 MHz ▪ Nominal impedance: 50 Ω ▪ VSWR: 2.5:1 ▪ Polarization: linear vertical ▪ Radiation pattern: omni directional ▪ Power rating: 3 W ▪ Gain: 0 min-2 max. ▪ Weight: 47 g (1.66 oz) ▪ Height: 228 mm (9 in) ▪ Width: 25 mm (1 in) ▪ Operating temperature: -30 to +70 °C (-22 to +158 °F) <p>Order code: 71329987</p>
<p>Fixed Antenna: LTE, GSM, UMTS, WLAN</p> 	<p>Fixed antenna for mounting on vertical surfaces. Usage: FXA42, FXA30</p> <ul style="list-style-type: none"> ▪ Applikation: <ul style="list-style-type: none"> - LTE 800 MHz - LTE 2.6 GHz - GSM 900 MHz - GSM 1800 MHz - UMTS - WLAN 2.4 GHz (WiMAX, WiFi) ▪ Cable length: 3 m (9.9 ft) ▪ Indoor and outdoor use ▪ Mounting via bracket ▪ Omnidirectional characteristic ▪ Radiator protected by a plastic tube ▪ HF-cable connected directly to antenna ▪ 100 mm (4 in) clearance between antenna by 15 dB isolation <p>Order code: 71327395</p>
<p>Mounting kit FXA30</p> 	<p>For wall mounting.</p> <ul style="list-style-type: none"> ▪ 4× small bracket ▪ 4× screw <p>Order code: 71336975</p>

Supplementary documentation



The following document types are available:

In the Download Area of the Endress+Hauser Internet site: www.endress.com/downloads

Standard documentation

Device	Document type	Document code
FXA30/FXA30B	Operating Instructions	BA1710S
	Brief Operating Instructions	KA01320S



71435499

www.addresses.endress.com