

Operating instructions

Chlorine dioxide systems

Bello Zon[®] type CDLb with internal pre-storage vessel

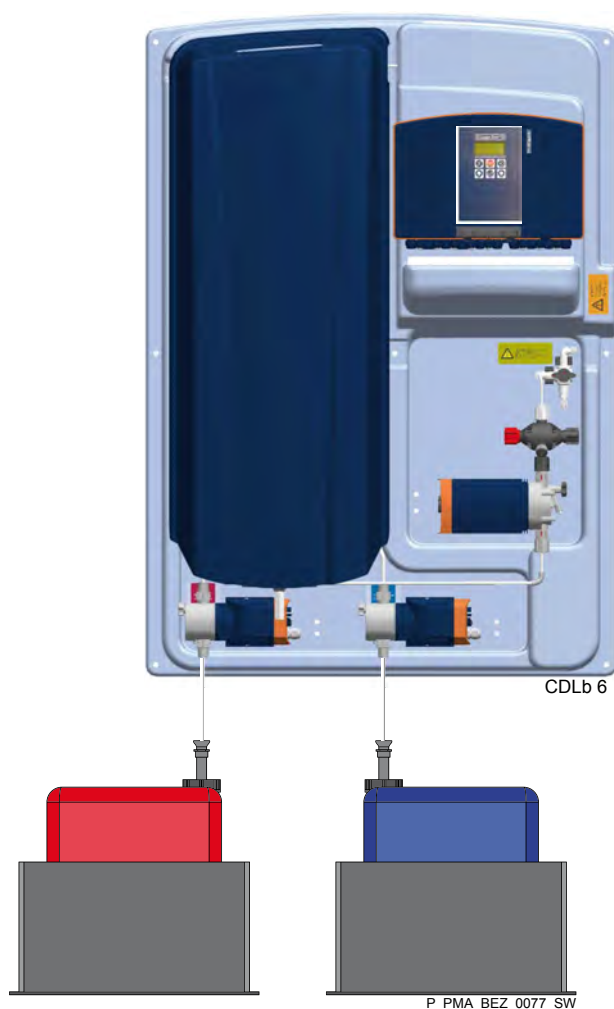

**Please carefully read these operating instructions before use! · Do not discard!
The operator shall be liable for any damage caused by installation or operating errors!
Technical changes reserved.**

Supplementary information



Fig. 1: Please read!

Read the following supplementary information in its entirety! Should you already know this information, you will benefit more from referring to the operating instructions.

The following are highlighted separately in the document:

- Enumerated lists
- refer to... References
- Instructions
- ⇒ Results

'User interface text'

[Keys]

Information



This provides important information relating to the correct operation of the unit or is intended to make your work easier.

Safety notes

Safety notes are identified by pictograms - see Safety Chapter.



The chapters "Control elements", "Start up" and "Operation" explain the setting menus in the sequence in which they arise.

Notes for the System Operator

This document includes notes and quotes from German guidelines relating to the system operator's scope of responsibility. This information does not discharge the operator from his responsibility as an operator and is intended only to remind him or make him aware of specific problem areas. This information does not lay claim to being complete, nor applicable to every country and every type of application, nor to being unconditionally up-to-date.

Version number of the hardware and software

The version number of the hardware and software can be found here:

Set metering to 'OFF' on the control ([Start/Stop] key) .

After [Change] has been pressed, the control switches to the Versions display.

In case of complaints, or if expanding the scope of use of the device, specify the version number in addition to the identity code.

Table of contents

1	Identify code	5
2	About this system	6
3	Safety chapter	7
4	Storage and transport	13
5	System overview	14
6	Functional description	15
	6.1 Chemical principle behind the systems.....	15
	6.2 System operating principle.....	15
	6.3 Safety equipment.....	15
7	Requirements at the installation site	16
	7.1 Requirements for the installation site.....	16
	7.2 Requirements for the water.....	17
8	Assembly	18
9	Installation	21
	9.1 Installation, hydraulic.....	21
	9.1.1 Filter insert.....	21
	9.1.2 System isolator.....	22
	9.1.3 Water meter.....	22
	9.1.4 Point of injection, Bello Zon® CDL.....	23
	9.1.5 Suction lances / suction assemblies for acid and chlorite..	25
	9.1.6 Water supply diluting water.....	26
	9.1.7 Drainage connection.....	26
	9.1.8 Chemical supply instructions.....	27
	9.1.9 Sample water connection.....	27
	9.2 Installation, electrical.....	27
	9.2.1 Wiring the control.....	27
	9.2.2 Connecting the terminals.....	29
	9.2.3 Installing an emergency stop switch.....	30
	9.2.4 Preparing the mains connection.....	30
10	Controlling the system	32
	10.1 Control elements.....	32
	10.2 Key functions.....	32
	10.3 Operating menu, schematic.....	33
	10.4 Operating menu, overview.....	35
11	Start up	36
	11.1 Setting the language.....	36
	11.2 Changing the user code.....	37
	11.3 Cancelling corrosion protection.....	37
	11.4 Setting the ClO ₂ metering.....	38
	11.5 Allocating the digital input.....	39
	11.6 Configuring alarm relay contact types.....	40
	11.7 Installing chemical drums.....	40
	11.8 Carrying out commissioning.....	41
12	Operation	45
	12.1 Changing the chemical drums.....	45
	12.2 Flush system.....	47
	12.3 Paging through the protocol.....	49
	12.4 Perform service.....	50
13	Maintenance	51
14	Repairs	52
15	Troubleshooting	53

16	Decommissioning	55
	16.1 For a short period.....	55
	16.2 Over longer periods.....	55
17	Disposal	56
18	Technical data CDLb	57
19	Accessories	60
20	EC Declaration of Conformity	62
21	Dimensional drawings	63
22	Interface list	68
23	Wiring diagram CDLb	69
24	Decontamination declaration	72
25	Chlorine dioxide hazardous substance data sheet	73
	25.1 Physical and chemical properties.....	73
	25.1.1 Chemical characterisation.....	73
	25.1.2 Properties of gaseous chlorine dioxide.....	73
	25.1.3 Properties of an aqueous solution of chlorine dioxide.....	73
	25.2 Handling aqueous chlorine dioxide solutions.....	74
	25.2.1 Labelling and characters.....	74
	25.2.2 Storage.....	74
	25.2.3 Measures in the event of spillage, escape, gas leaks.....	74
	25.2.4 Measures in the event of fires.....	74
	25.2.5 Disposal.....	74
	25.3 Health protection.....	74
	25.3.1 MAC value and odour threshold.....	74
	25.3.2 Personal protective equipment.....	74
	25.3.3 Health hazards.....	75
	25.3.4 First Aid.....	75
	25.4 More Information.....	75
26	Index	76

1 Identity code

The identity code is shown on the system nameplate.

Product range CDL, Version b			
CDLb	Type	Production performance	
02	6	6 g/h	
04	12	12 g/h	
06	22	22 g/h	
08	55	55 g/h	
10	120	120 g/h	
Equipment			
	0	With internal pre-storage vessel, pump and multifunctional valve (only up to 55 g/h)	
	1	With internal pre-storage vessel and pump (only up to 55 g/h)	
	2	With internal pre-storage vessel (only up to 55 g/h)	
	3	With external pre-storage module	
Design			
	P	ProMaqua	
	H	Switzerland	
Operating voltage			
	0	230 V, 50/60 Hz	
	1	115 V, 50/60 Hz	
Suction lance			
	0	no suction lance	
	1	with suction lance	
	2	with suction lance and collecting pan	
Language			
	DE	German	
	EN	English	
	ES	Spanish	
	FR	French	
	IT	Italian	

2 About this system

The Bello Zon® CDLb chlorine dioxide generating and metering system is designed for drinking water treatment - especially in respect of water disinfection using chlorine dioxide.

The control provides an appropriate amount of diluting water in the mixer vessel and mixes it with precisely measured quantities of hydrochloric acid and sodium chlorite, which are metered using two measuring vessels and two metering pumps. This creates a ClO₂ solution with a concentration of 2 g/l (CDLb 6: 1 g/l). Thanks to the lower concentration relative to other processes, the process is particularly safe.

The produced ClO₂ solution flows into the internal pre-storage vessel, from which it can be dosed using the metering pumps.

3 Safety chapter







Identification of safety notes

The following signal words are used in these operating instructions to denote different severities of danger:

Signal word	Meaning
WARNING	Denotes a possibly dangerous situation. If this is disregarded, you are in a life-threatening situation and this can result in serious injuries.
CAUTION	Denotes a possibly dangerous situation. If this is disregarded, it could result in slight or minor injuries or material damage.

Warning signs denoting different types of danger

The following warning signs are used in these operating instructions to denote different types of danger:

Warning signs	Type of danger
	Warning – corrosive substances.
	Warning – automatic start-up.
	Warning – high-voltage.
	Warning – explosive substances.
	Warning – toxic substances.
	Warning – danger zone.

The basic rules

Firstly always observe these two basic rules:

1. - **The two chemicals Bello Zon® acid (dilute HCl) and Bello Zon® chlorite (dilute NaClO₂) must never be brought into contact except in the mixer vessel!**
Otherwise hazardous ClO₂ gas forms!
2. - **Never operate the chlorine dioxide Bello Zon® CDL with incorrectly diluted acid or incorrectly diluted sodium chlorite!**
Otherwise ClO₂ concentrations are formed for which the system is not designed! Moreover chlorite concentrations that are harmful to health can form in the treated water.

Intended use

- CDLb type systems are solely suited to the production of a chlorine dioxide solution of 2 g/l concentration (CDLb 6: 1 g/l) from dilute hydrochloric acid (9 %) and sodium chlorite solution (7.5 %).
Systems with an internal storage tank store the chlorine dioxide solution for further use.
Systems with an internal storage tank and integral metering pump store and meter the chlorine dioxide solution into water that is to be treated.
- All other uses or a modification of the system are only permitted with the written authorisation of ProMinent, Heidelberg!
- Systems of type CDLb must only be operated under the conditions described in the technical data!
- Do not allow untrained personnel to operate systems of type CDLb! All other activities should only be carried out by personnel trained by ProMinent or personnel who have been authorised by ProMinent – see the table below!
- You are obliged to observe the information contained in the operating instructions at the different phases of the system's service life!
- Please observe the relevant national regulations and guidelines at every phase of the device's service life!

Qualification of personnel



WARNING!

According to accident statistics, holiday replacements are a safety risk.

- Holiday replacements should also be qualified, as outlined below, and have been instructed accordingly.

Task	Qualification
Assembly / installation	ProMinent service technicians or competent persons authorised by ProMinent
Initial commissioning	ProMinent service technicians or competent persons authorised by ProMinent
Start up	Technical experts
Operation, canister replacement	Instructed person
Maintenance, repair	ProMinent service technicians or competent persons authorised by ProMinent
Decommissioning, disposal	ProMinent service technicians or competent persons authorised by ProMinent
Troubleshooting simple faults	Instructed person
Troubleshooting difficult faults	ProMinent service technicians or competent persons authorised by ProMinent

Explanation of the table:

Technical experts

A technical expert is deemed to be a person who is able to assess the tasks assigned to him and recognise possible hazards based on his/her technical training and experience, as well as knowledge of applicable regulations.

Note:

A technical qualification is typically proven by the required completion of a technical training course, e.g. as an engineer or craftsman. The assessment of a person's technical training can also be based on several years of work in the relevant field.

Qualified employee

A qualified employee is deemed to be a person who is able to assess the tasks assigned to him and recognise possible dangers based on his/her technical training, knowledge and experience, as well as knowledge of pertinent regulations.

Note:

A qualification of equal validity to a technical qualification can also be gained by several years of employment in the relevant field of work.

Instructed person

An instructed person is deemed to be a person who has been instructed and, if required, trained in the tasks assigned to him/her and possible dangers that could result from improper behaviour, as well as having been instructed in the required protective equipment and protective measures.

Service

The Service department refers to service technicians, who have received proven training and have been authorised by ProMinent to work on the system.

Personal protective equipment

The following represents the current situation in Germany at the time of going to print of the operating instructions:

- Face mask
- Rubber or plastic boots
- Protective gloves (ClO₂-resistant design!)
- Protective apron
- Full-face protective mask
- 1 replacement filter per protective mask

Description and testing of safety equipment

Chlorine dioxide systems Bello Zon® CDLb are designed according to the DVGW (German Technical and Scientific Association for Gas and Water) specifications W 224 and W 624. They include the following safety equipment:

Safety instruction stickers

The following represents the current situation in Germany at the time of going to print of the operating instructions:

The stuck-on safety instructions must always be fitted and legible.

This includes the two red and blue stickers for dilute acid and dilute chlorite ("Do not interchange connectors...").

And these two stickers:



Fig. 2: Sticker "Before opening the device ..."

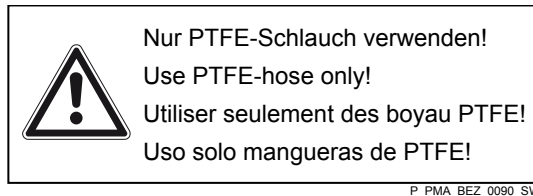

Fig. 3: Sticker "Only PTFE tube..."

The following sticker must be attached to the exhaust gas lung:

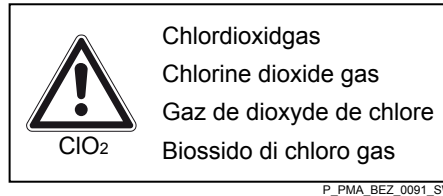

Fig. 4: Sticker "Chlorine dioxide gas"

Chemical drum safety collecting pans (accessories)

The safety collecting pans should prevent chemicals escaping in an uncontrolled manner from a defective chemical drum or even mixing with other chemicals.

Safety notes



WARNING!

Danger from incorrect operation

Incorrect operation can result in dangerous conditions for the system and its surroundings.

- All operating personnel should be instructed by a ProMinent service technician! (Takes place during initial commissioning and is documented in the commissioning report.)
- The operating instructions should be available adjacent to the system.



WARNING!

Danger from hazardous substances!

Possible consequence: Fatal or very serious injuries.

Please ensure when handling hazardous substances that you have read the latest safety data sheets provided by the manufacture of the hazardous substance. The actions required are described in the safety data sheet. Check the safety data sheet regularly and replace, if necessary, as the hazard potential of a substance can be re-evaluated at any time based on new findings.

The system operator is responsible for ensuring that these safety data sheets are available and that they are kept up to date, as well as for producing an associated hazard assessment for the workstations affected.

**WARNING!****Danger due to hazardous substances**

By operating this system the operator generates hazardous substances.

The operator is responsible for adapting the operating instructions to their system in the event that more recent knowledge about the dangers associated with a hazardous substance and its avoidance become available or national regulations prescribe something else to that stated in the supplied operating instructions.

**WARNING!****Risk of explosion due to chlorine dioxide without safety measures**

Under rare fault conditions ClO₂ solution can escape via a leak.

- A gas detector must be installed if no other measure is provided to ensure personnel safety in the event of ClO₂ escaping so that the system switches off and an alarm is triggered that can be seen/heard from afar.

**CAUTION!**

Attach warning signs at the place of installation of the Bello Zon® CDLb and in the chemical storage rooms, in accordance with the local regulations.

**CAUTION!****Warning against illegal operation**

Observe the regulations that apply where the device is installed.

Instructions for entering a room in which chlorine dioxide systems are installed

- Access only for trained personnel.
- If there is a smell of chlorine dioxide (pungent, chlorine-like smell) access is only permitted to personnel wearing the specified protective equipment.
- If there is a smell of chlorine dioxide, immediately switch off the system from a safe position, e.g. emergency stop switch, which is installed at a distance from the system.

Note for the system operator

Keywords when searching for the necessary regulations:

- Chlorine dioxide systems
- Chlorine dioxide (possibly chlorination as well)
- Potable water
- Food
- Hydrochloric acid
- Sodium chlorite
- Storage
- Hazardous substances
- Personal protective equipment

Information in the event of an emergency

- You have already come into contact with acid: See the latest "Acid safety data sheet" provided by the supplier!
- You have already come into contact with chlorite: See the latest "Chlorite safety data sheet" provided by the supplier!
- You have come into contact with ClO_2 solution or ClO_2 gas: Refer to "Chlorine dioxide hazardous substance" data sheet: Properties of chlorine dioxide and instructions for handling aqueous solutions" in the appendix or a more recent hazardous substance data sheet.

Sound pressure level

Sound pressure level $L_{pA} < 70$ dB according to EN ISO 20361
at maximum stroke length, maximum stroke rate, maximum back pressure (water)

4 Storage and transport

Safety notes



WARNING!

Only return the device for repair in a cleaned state and with hydraulic components - refer to the chapter "Decommissioning"!

Only send the unit complete with a filled in Decontamination Declaration form. The Decontamination Declaration constitutes an integral part of an inspection / repair order. A unit can only be inspected or repaired when a Decontamination Declaration Form is submitted that has been completed correctly and in full by an authorised and qualified person on behalf of the operator.

The "Decontamination Declaration Form" can be found in the Appendix or under www.prominent.com.



CAUTION!

Danger of material damage

The device can be damaged by incorrect or improper storage or transportation!

- The unit should only be stored or transported in a well packaged state - preferably in its original packaging.
- The packaged unit should also only be stored or transported in accordance with the stipulated storage conditions.
- The packaged unit should be protected from moisture and the ingress of chemicals.

Packaging

The chlorine dioxide Bello Zon® CDL system is supplied in wooden packaging.

Ambient conditions

Data	Value	Unit
Minimum storage and transport temperature	+5	°C
Maximum storage and transport temperature	+50	°C
Maximum air humidity *	92	% rel. humidity

* non-condensing

Miscellaneous: Protect against sunlight

Scope of supply

In addition to the identity code options, the scope of supply includes:

- The mounting kit (mounting equipment and threaded cable glands)
- Labels for suction lances / suction assemblies
- Warning signs - see chapter "Mounting and hydraulic installation"

5 System overview

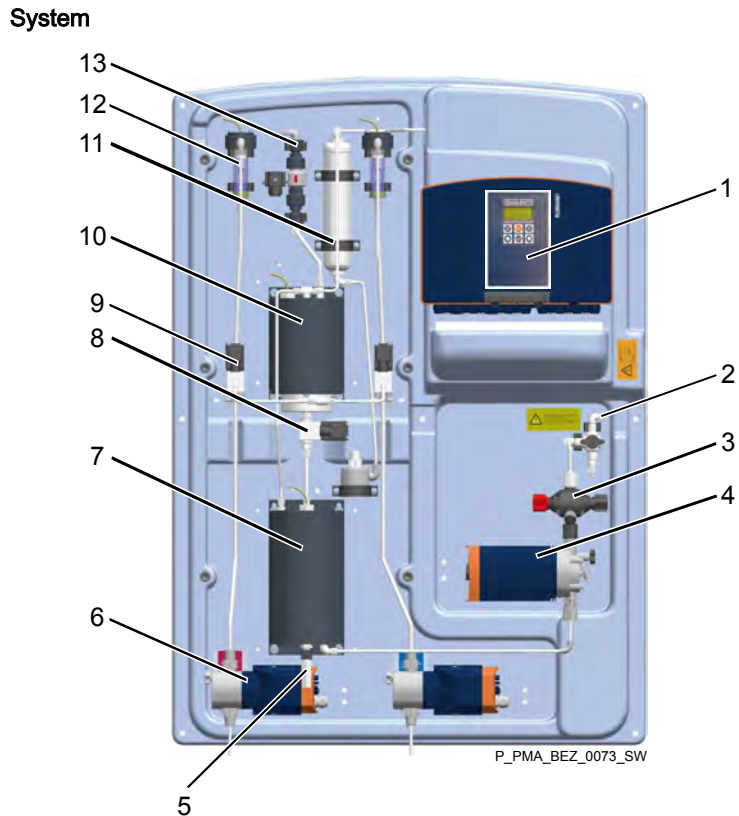

Fig. 5: System overview CDLb 22

- | | |
|-----------|--|
| 1 | Control |
| 2 | 3-way valve with outlet for ClO ₂ solution *) |
| 3 | Multifunctional valve *) |
| 4 | Chlorine dioxide metering pump *) |
| 5 | Storage tank outlet valve |
| 6 | Acid metering pump (HCl) |
| 7 | Pre-storage vessel *) |
| 8 | Solenoid valve ClO ₂ |
| 9 | Solenoid valve acid |
| 10 | Mixer vessel |
| 11 | Active carbon filter |
| 12 | Acid measuring vessel |
| 13 | Solenoid valve diluting water |
| not shown | Safety collecting pan (option) |
| not shown | Exhaust gas "lung" (behind the control) |
| *) | Identity code option |



*For the sake of clarity, only device parts of the **acid metering line** are identified.*

*The corresponding device parts for the **chlorite metering line** are always located in a mirror image fashion to the right of the corresponding acid device component.*

6 Functional description

6.1 Chemical principle behind the systems

Operate chlorine dioxide systems Bello Zon® according to the hydrochloric acid-chlorite process:

Hydrochloric acid + sodium chlorite = chlorine dioxide + sodium chloride + water

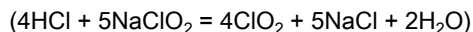

The Bello Zon®CDLb systems produce a 0.2 % chlorine dioxide solution (2 g/l ClO₂ or 1 g/l for the CDLb 6) through the combination of dilute hydrochloric acid and dilute sodium chlorite solution.

6.2 System operating principle

General description

The control provides an appropriate amount of diluting water in the mixer vessel. Two metering pumps meter the chemicals Bello Zon® acid and Bello Zon® chlorite into their respective measuring vessels until the level switches in the vessels trigger. The control then empties the acid and chlorite into the mixer vessel. After a defined reaction time has elapsed, the control fills the mixer vessel with water until the vessel's level switch triggers. This ensures that the produced solution is well mixed.

Thereupon, the control empties the content of the mixer vessel into the internal storage tank. If also commanded, the third metering pump doses this ClO₂ solution. The metering, which is requirement-dependent, is controlled using the signal from a water meter.

In versions "with internal pre-storage vessel" this ClO₂ solution can be further processed using a supplied metering pump or a site-supplied facility.

Definitions



- "System" comprises the totality of the control for the Bello Zon® system and everything located on its panel.
- The "control" refers to the control in the housing on the panel of the Bello Zon® system.

6.3 Safety equipment

The description of the safety equipment is contained in the chapter "Safety Chapter".

7 Requirements at the installation site

Safety notes



CAUTION!

Warning against illegal operation

Observe the regulations that apply where the device is installed.

7.1 Requirements for the installation site

- The chlorine dioxide system must not be located outdoors.
- It must be possible to protect the chlorine dioxide system against unauthorised access.
- The site of the chlorine dioxide system must be protected against solar radiation and also be frost-proof and well ventilated.
- It must be possible to transport the chemical drums to the system without obstruction.
- There must be an emergency exit route.
- For installation of the Bello Zon® CDL system, a smooth, vertical wall must be available.
- It should be possible to install the Bello Zon®CDL system so that the chemical drums can be readily placed beneath it (bottom edge of the Bello Zon® at least 1 m above the ground).
- A measuring point should be provided. The sample water line (or a sampling tap) should be situated at least 2 m downstream of the point of injection and before the first sampling point.
- A water connection for the diluting water is necessary (minimum pressure 3 bar).
- A water tap must be installed so that spilled chemicals can be cleared without danger.
- A floor drain must be installed so that spilled chemicals can be cleared without danger.
- It must be possible to fit a gas detector.
- There must be a mains connection, with an emergency stop switch outside the installation room.

Note for the system operator

The following applicable regulations (within Germany) provide more detailed information:

- The accident prevention regulation (UVV) "Chlorination of Water", [in German] GUV-V D5 (previously GUV 8.15), April 1979
- "Chlorine dioxide dosing systems", DVGW Merkblatt (data sheet) W 624, DVGW e.V., Eschborn, 02/2010
- "Chlorine dioxide in water treatment", DVGW Merkblatt (data sheet) W 224, DVGW e.V., Eschborn, ISSN 0176-3504
- The directives for the protection of ground water against pollution [in German] (section 19 of the German Federal Water Act (WHG) Edition 31/07/2009)
- The German Ordinance on Hazardous Substances (GefStoffV) - especially section 17 (general duty of protection) and section 20 (operating instructions; see also Accident Prevention Regulations section 9) [in German]

7.2 Requirements for the water



CAUTION!

Warning of operating disruptions and corrosion damage

Severe system operating disruptions and corrosion of your piping system can occur.

- Always fulfil requirements in respect of the diluting water and the water to be treated.

Diluting water

Parameter	Value
Temperature:	10 - 30 °C
Pressure:	3 - 6 bar
Quality:	Drinking water, particle-free, non-corrosive

Water to be treated

Parameter	Value*
Temperature:	0 - 60 °C
Pressure, max. CDLb 6:	10 bar **
.....CDLb 12:	7 bar **
.....CDLb 22:	7 bar **
.....CDLb 55:	7 bar **

* Dependent on the material of the injection point used and the water temperature

For the version "With internal pre-storage vessel": Also dependent on the external metering pumps.

** With integral metering pump



CAUTION!

Warning of too-low ClO₂ concentration

Certain dissolved matter can deplete ClO₂.

- Bear in mind that a depletion of ClO₂ by the matter dissolved in the water can occur.
Likewise bear in mind the simultaneous formation of chlorite.

8 Assembly

Safety notes



WARNING!

Danger due to the sudden unexpected escaping of toxic chlorine dioxide solution

The seals which are exposed to chlorine dioxide solution, will start to leak if they are not replaced early enough.

- The system must be set up so that it can be accessed easily for maintenance.

Fitting the panel



The supplied mounting kit contains the necessary hanger bolts, rawplugs, washers and nuts (mounting kit = plastic bags with fixings and threaded cable glands...).

Select the mounting height so that:

- The LCD screen of the control can be easily read
- The fluid level of the full chemical drums is below the metering pumps
- The maximum priming lift of the metering pumps is not exceeded, see table "Technical data" in the appendix
- There is still sufficient space for the chemical drums below the bracket.

Priming lift metering pumps, max.* 2 m water column

** With clean and moist valves, feed chemical water (20 °C), at 100 % stroke length ("Pump" symbol), 180 strokes/min, opened bleed valve (applies for CDLb metering pumps)



*Secure the Bello Zor® system on a suitable, smooth and vertical wall, as close as possible to the point of injection.
Dimensions sheets - see appendix*

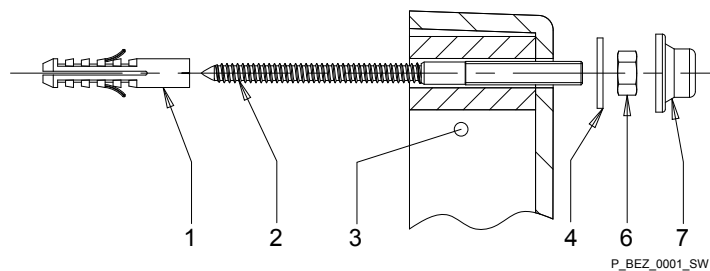

Fig. 6: Fastening of deep drawn bracket

- 1 Rawplug
- 2 Hanger bolt
- 3 Panel
- 4 Washer (plastic)
- 6 Hexagon nut
- 7 Protective cap

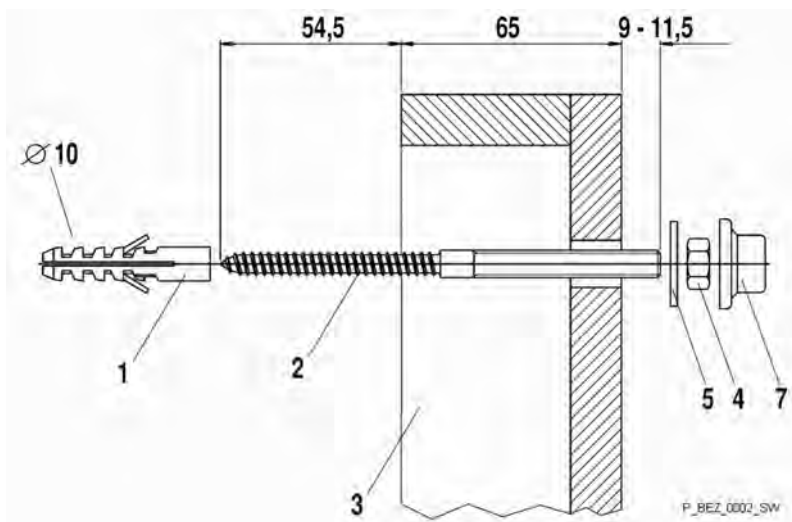



Fig. 7: Fastening of welded bracket

- 1 Rawplug
- 2 Hanger bolt
- 3 Panel
- 4 Hexagon nut
- 5 Washer (metal)
- 7 Protective cap

1. ➔ After fitting, brush the metallic fastenings with Vaseline to prevent corrosion.
2. ➔ Attach the warning signs according to the national regulations at the access to the chlorine dioxide system and the chemical stores or any other locations so that they are clearly visible (Warning signs according to German regulations (08/2012) form part of the scope of supply).

Warning labels



CAUTION!
Warning against illegal operation
 Observe the regulations that apply where the device is installed.

Provided national regulations do not require otherwise, used signs of the form and type given below.

a) Attach both these signs together at the entrances to rooms in which Bello Zon® chlorine dioxide systems are set up:

Warning sign *	Warning label *	Included text
	<div style="border: 1px solid black; padding: 5px; width: fit-content; margin: 0 auto;"> Chlor. dioxide equipment Access only for trained personnel <small>P_BEZ_0004_SW</small> </div>	Chlorine dioxide system. Access only for trained personnel.
<p>* Mandatory in Germany</p>		

b) Attach both these signs together at the entrances to rooms in which sodium chlorite (Bello Zon® chlorite) is stored or used:

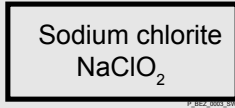
Warning sign *	Warning label *	Included text
		Sodium chlorite NaClO ₂
* Mandatory in Germany		

c) Attach this sign in rooms in which sodium chlorite (Bello Zon® chlorite) is handled:

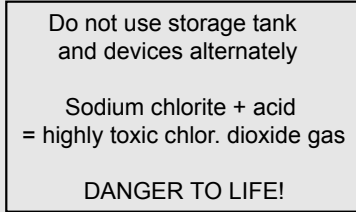
Warning label *	Included text
	Do not interchange storage tanks and devices. Sodium chlorite + acid = highly toxic chlorine dioxide gas. Danger to life!
* Mandatory in Germany	

This applies to stores and decanting rooms in which the chemical drums are set up, which are then connected to the Bello Zon® systems.

9 Installation



CAUTION!

Warning against illegal operation

Observe the regulations that apply where the device is installed.



An interface list is contained in the appendix.

9.1 Installation, hydraulic

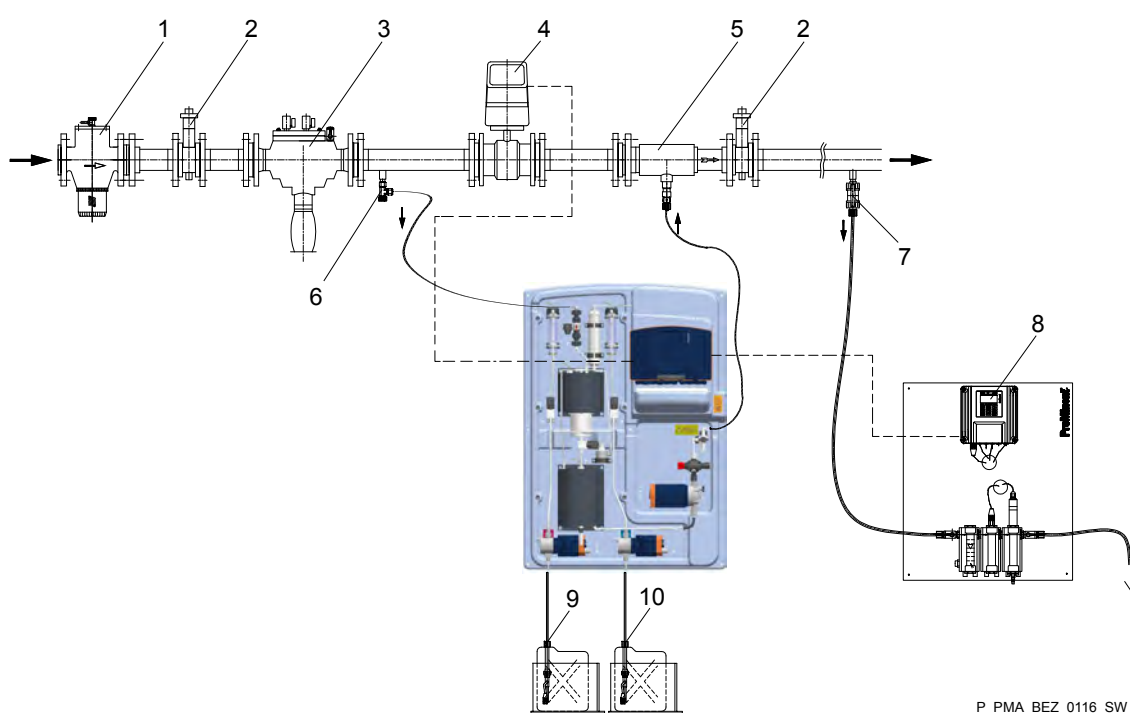

Fig. 8: Typical installation of a CDLb with internal pre-storage vessel

- | | | | |
|---|------------------------------------|----|---|
| 1 | Filter insert | 6 | Angle valve |
| 2 | Shut-off valve | 7 | Sample water line (or sampling tap) |
| 3 | System isolator | 8 | Measuring station |
| 4 | Water meter | 9 | Suction lance with Bello Zon® acid in safety collecting pan |
| 5 | Point of injection, Bello Zon® CDL | 10 | Suction lance with Bello Zon® chlorite in safety collecting pan |

The following sub-chapters contain notes for the hydraulic installation.

9.1.1 Filter insert

To protect the plant and fittings, first of all install a filter insert in the diluting water line.

9.1.2 System isolator



WARNING!

Warning against unchecked through-suction

If the line that is carrying the water to be treated is subject to a vacuum pressure, then unchecked through-suction of the ClO₂ solution can occur.

- Fit a system isolator.
- Fit a backpressure-free back pressure valve upstream of the injection point, if a constant back pressure of 1.5 bar is not ensured in any other way.

9.1.3 Water meter

Safety notes



WARNING!

The ClO₂ concentration at the point of injection can increase greatly and lead to health problems. Moreover corrosion of the pipes can occur.

- It must not be possible for water absorption to occur between the water meter and the point of injection.



WARNING!

The ClO₂ concentration in the treated water may be incorrect due to inaccurate measured values.

- Ensure that the sections of pipe upstream and downstream of the water meter confirm to the specifications in its operating instructions.

Possible types

The control of the Bello Zon® system processes signals from the following water meter types:

- Magnetic inductive water meter (IDM) with frequency output (< 10 kHz)
- Contact water meter with Hall sensor (< 20 Hz)
- Contact water meter with reed switch (< 20 Hz)
- Contact water meter with inductive pulse generator (Namur) (< 20 Hz)



Avoid problems with the water meter.

Where possible use an IDM (magnetic inductive water meter)

Place of installation

The water meter must be fitted downstream of the system isolator and upstream of the point of injection, see Fig. at the start of the chapter. It must measure the entire water quantity that is to be treated!

Selection

To ensure continuous dosing of ClO₂ solution, contact water meters must be selected according to the following table:

Maximum emitted frequency of the contact water meter [in lmp/h (Hz)] dependent on the contact gap of the water meter and the maximum flow

Contact gap ⇒ Max. flow ↓	1.0 l/Imp	2.0 l/Imp	4.0 l/Imp	10.0 l/Imp
1 [m ³ /h]	1,000 (0.3)	500 (0.14)*	250 (0.07)*	100 (0.03)*
2 [m ³ /h]	2,000 (0.6)	1,000 (0.3)	500 (0.14)*	200 (0.06)*
5 [m ³ /h]	5,000 (1.4)	2,500 (0.7)	1,250 (0.3)	500 (0.14)*
10 [m ³ /h]	10,000 (2.8)	5,000 (1.4)	2,500 (0.7)	1,000 (0.3)
20 [m ³ /h]	20,000 (5.6)	10,000 (2.8)	5,000 (1.4)	2,000 (0.6)
50 [m ³ /h]	50,000 (13.9)	25,000 (6.9)	12,500 (3.5)	5,000 (1.4)
100 [m ³ /h]	100,000 (27.8)*	50,000 (13.9)	25,000 (6.9)	10,000 (2.8)

* The Namur input cannot be used here:

Frequency > 20 Hz and/or < 0.25 Hz.

 Where possible water meters should be used with a contact separation of 1 l/pulse.

9.1.4 Point of injection, Bello Zon® CDL

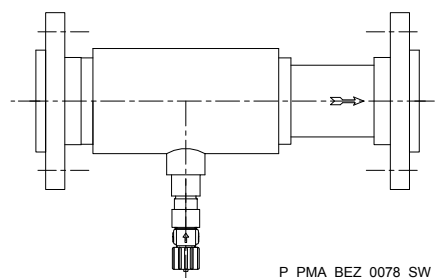

 **WARNING!**
Danger of back pressure effects
 If incorrectly installed, the integrated non-return valve may not close.

- Install the ClO₂ connector of the point of injection so it points vertically downwards

 **WARNING!**
Warning of toxic ClO₂
 If the metering line is made from inappropriate material, e.g. PE, it may leak.

- Always use PTFE tube, e.g. 6x4 mm, order no. 37426 or equivalent.



WARNING!

Warning of too-low ClO₂ concentration

UV radiation, e.g. from fluorescent strip lights or sunshine, or bright light can cause the ClO₂ in the metering line to decompose.

- Protect the metering line against UV radiation and bright light.



WARNING!

Personnel danger

If during installation work an electrically conducting pipe has been interrupted, personnel and devices are placed under substantial risk, e.g. if a lightning strike occurs.

- Provision must then be made to ensure suitable potential equalisation (e.g. connect the pipe ends at the point of separation using a suitable metal bridge or strap)



WARNING!

Warning against through-suction

If the point of injection starts to leak, then unchecked through-suction of the ClO₂ solution can occur.

- Only use corrosion-proof injection points.
- Take into account the temperature dependent on the maximum permissible operating pressure of the point of injection, see ↪ *'Dependency of the maximum permissible operating pressure on the water temperature for the point of injection Bello Zon® CDL'* Table on page 25.

Install the point of injection in the main water supply line at a suitable point (to minimise corrosion and optimise mixing) e.g. point of injection Bello Zon® CDL:

Flange connection	Material	Flow	Fitting length	Order no.
		m ³ /h		
DN50	PVC-U	15	450	1027611
DN65	"	25	400	1026490
DN80	"	35	400	1027612
DN100	"	50	470	1034693
DN125	"	90	550	1047692
DN150	"	160	680	1047693
DN65	PVC-C	25	400	1029326
DN80	"	35	400	1029327

Dependency of the maximum permissible operating pressure on the water temperature for the point of injection Bello Zon® CDL

Water temperature	Maximum permissible operating pressure	
°C	bar	
	PVC-U	PVC-C
40	12	12
50	7	9.5
60	4.5	7.5

9.1.5 Suction lances / suction assemblies for acid and chlorite

Safety notes



WARNING!

Warning of toxic chlorine dioxide gas

Toxic chlorine dioxide can arise outside the mixer vessel.

- Allocate parts correctly to the acid and chlorite sides.



WARNING!

Warning of corrosive acid or toxic chlorite solution

Corrosive acid or toxic chlorite can escape at the connectors.

- Only use suitable hoses and connector kits.



Only use suction lances or suction assemblies with two-stage level switches and open end. Other suction lances do not fit.

Installing suction hoses

Do not insert the suction lances into the chemical drums yet!

1. Adjust the length of each suction lance - the foot valve should subsequently float in the container just above the base.
2. Stick the "Acid" and "Chlorite" labels (in the scope of supply) onto the suction lance heads or suction hoses so they are clearly legible.



"Acid", red, is attached on the left - "Chlorite", blue on the right!

3. Shorten the suction hoses so that subsequently they rise continuously and are free from tension.
4. Pull the union nut (4) and clamp ring (3) over the suction hose (5) - see figure .
5. Push the hose end over the nozzle (2) until it will go no further (it may be necessary to slightly widen the hose end).
6. Fit the nozzle on the pump suction valve (1).
7. Press the suction hose (5) onto the nozzle (3) and tighten the union nut (4).

8. ➔ Pull briefly on the suction hose (5) and tighten up the union nut (4).
9. ➔ In just the same way, connect the bleed hoses from the measuring vessels up into the suction lances.



Do not push the hose ends too deeply into the suction lances - they should not be immersed in the liquid in the chemical canister

Otherwise this could result in operational malfunction.

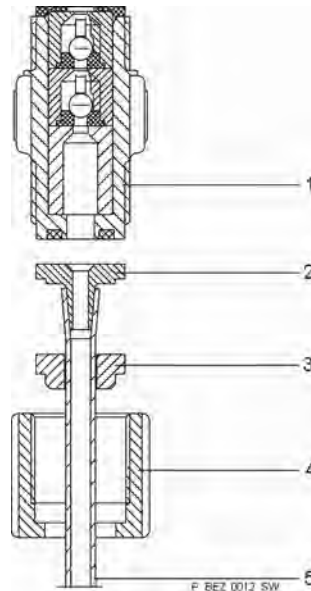

Fig. 9: Installing the hose

- 1 Pump suction valve
- 2 Nozzle
- 3 Clamp ring
- 4 Union nut
- 5 Hose

9.1.6 Water supply diluting water

The diluting water is fed to the system via a tube connection.
Use particle-free potable water that is non-corrosion inducing!

9.1.7 Drainage connection



WARNING!

Warning of toxic ClO₂ solution

The drainage connection incorporates a blanking plug, which should only be removed during bleeding or drainage.

The drain connection for the internal pre-storage vessel, complete with hose connector, is located at the bottom of the pre-storage vessel.

- ➔ To open the drainage connection turn the black ring in a counter-clockwise direction (approximately 1 turn).

9.1.8 Chemical supply instructions



WARNING!

Chemicals may escape

If the filling level of the chemical drums lies above the top edge of the Bello Zon® system or the point of injection, then if a leak occurs on the suction side of a metering pump, chemicals can escape.

- The top edges of the chemical drums must be below the bottom edge of the Bello Zon® system or the point of injection.

The system is supplied with chemicals from one 25 l chemical drum each of Bello Zon® acid and Bello Zon® chlorite.

9.1.9 Sample water connection

The sample water line (or a sampling tap) must be situated at least 2 m downstream of the point of injection and before the first sampling point.

9.2 Installation, electrical



WARNING!

Always install an overload and short circuit protection for the Bello Zon® system.



WARNING!

Only use flexible cabling for all additional cable connections (contact water meter, ...)!



WARNING!

Should it has been opened, the transparent interface cover beneath the key panel must be screwed on so that it is protected against moisture-ingress!

Otherwise the IP65 degree of protection is not achieved.

9.2.1 Wiring the control

1. ➤ Ensure that the control is not live and cannot be switched on!
2. ➤ Loosen the 4 housing screws and place the front part in the parked position.
3. ➤ Plan which holes will be broken out (colour the desired holes)



Parts inside the device could be damaged.

When breaking out the holes, avoid pushing the screwdriver deep into the housing!

4. To break out the holes, puncture the slit in the middle of the holes using a medium-sized screwdriver (tip width 3.5 - 4 mm) and lever the material out - see figure.

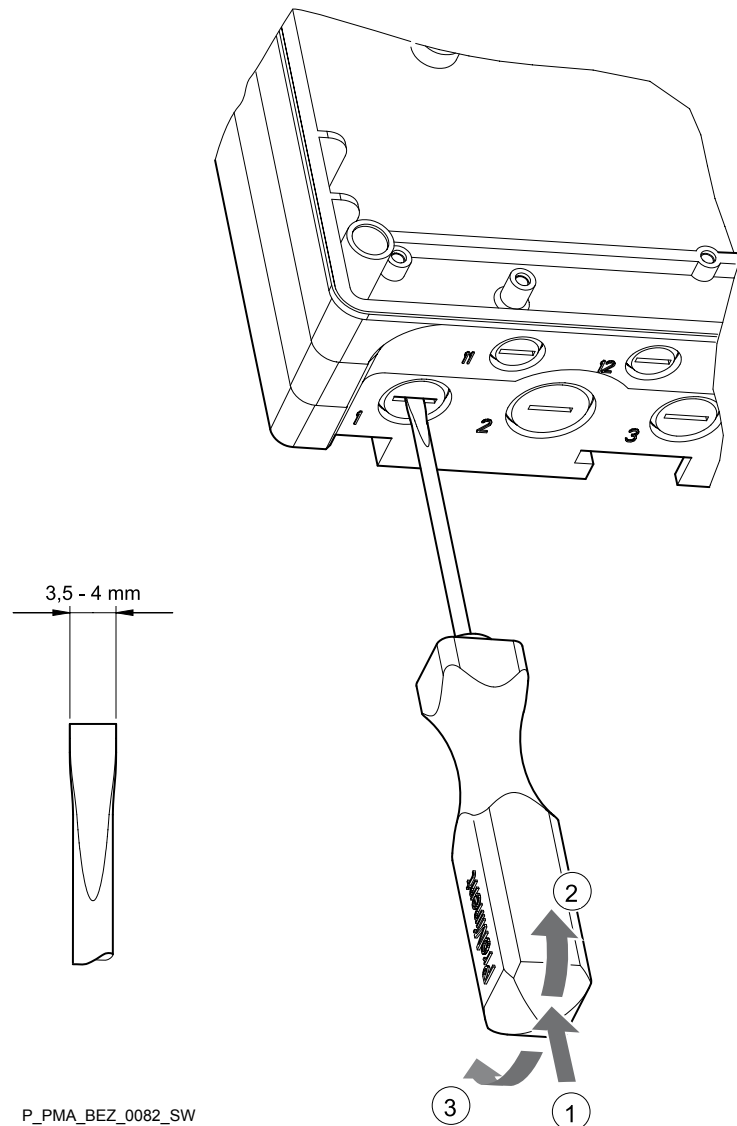

P_PMA_BEZ_0082_SW

Fig. 10

5. Smooth the edges.
6. Screw in the appropriate threaded cable glands (see on page 27, 2) using suitable lock nuts (1) and tighten firmly.
7. Insert multiple seal inserts (3) in the threaded cable glands according to the cable diameter being used.
8. Feed cables into the threaded cable glands. Where there are multiple sealing inserts (see Fig. 11), observe the permitted cable cross-section, see "Table Clamping Range" in the "Wiring diagrams" chapter.
9. Further steps are contained in .
Thereafter please continue with the following steps:
10. Tighten the union nuts (see , item 4) of the threaded cable glands so that they are leak-tight.

11. Fit the front part on the rear part.

**WARNING!****Danger of an electric shock**

If moisture penetrates into the control, an electric shock may occur.

- Once again check the seating of the seals to ensure an IP 65 degree of protection rating is correctly achieved.
- Seal any unused broken out holes with blanking plugs from the supplied supplementary kit.

12. Check the seating of the seal once again.

13. Manually tighten the housing screws until hand-tight.

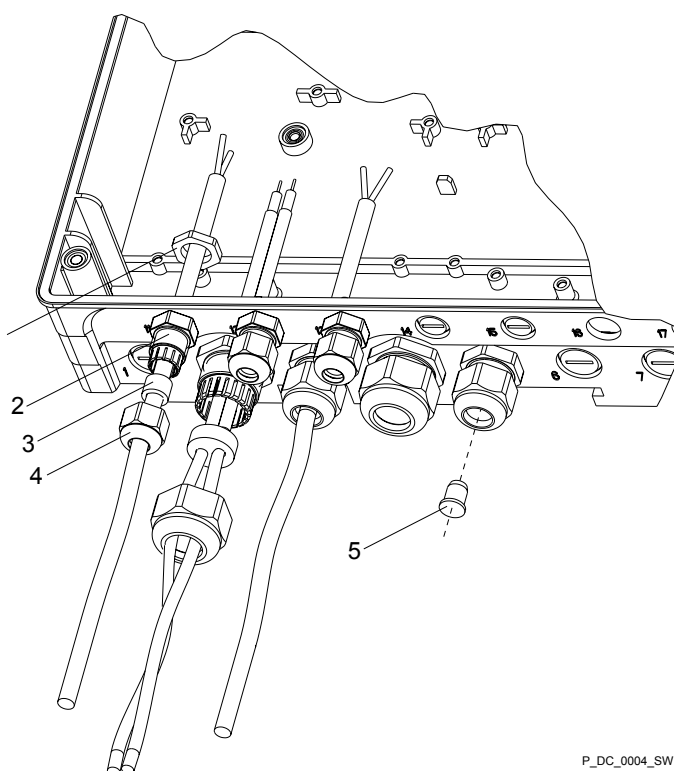

P_DC_0004_SW

Fig. 11: Fitting the threaded cable gland

- 1 Lock nut
- 2 Threaded cable gland
- 3 Multiple seal insert
- 4 Union nut
- 5 Blanking plug

9.2.2 Connecting the terminals



To install the leads for terminals XK1 to X2 simply insert the leads into the terminals. To release the leads for terminals XK1 to X2 again, simply press on the white button of the required terminal using the tip of a ball-point pen and pull the lead out.

1. ➤ Remove the cable insulation according to Fig. 12 and crimp on the corresponding cable end sleeves.
2. ➤ Connect the cables according to the wiring diagram.
3. ➤ Check all of the cabling using the wiring diagram.
4. ➤ Tighten the clamping screws of the cable glands until they are leak-tight.



- To install the leads for terminals XE1 to XA1 simply insert the leads into the terminals.
- To release the leads for terminals XK1 to X2 again, simply press on the white button of the required terminal using the tip of a ball-point pen and pull the lead out.
- The wiring diagram is contained in the appendix.

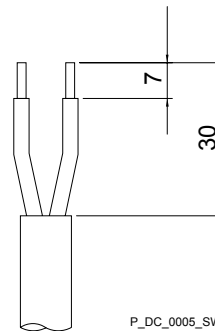

Fig. 12: Removing the wiring insulation

9.2.3 Installing an emergency stop switch



WARNING!

After particular incorrect operations or faults, it can be dangerous to approach the system. Then you must at least switch it off using an emergency stop switch, which is located at a safe distance.

- Install an emergency stop switch in the power supply line or include the system in the emergency stop management of the system.
- The emergency stop switch must be installed in an easily accessible, invulnerable position in the vicinity of the door of the installation room of the chlorine dioxide system and must be labelled as such.
- The emergency stop switch must disconnect the electrical supply equipment connected to the system from the mains.

9.2.4 Preparing the mains connection



CAUTION!

If the system is started up unintentionally, chlorine dioxide may arise within the system.

- Only connect the Bello Zon® system to the mains voltage upon start up!



CAUTION!

Warning against illegal operation

Observe the regulations that apply where the device is installed.

- - - Preparation of the Bello Zon® system is now sufficient to permit its starting up by a ProMinent service technician! - - -

10 Controlling the system

This chapter summarises which elements can be used to control the system.

10.1 Control elements

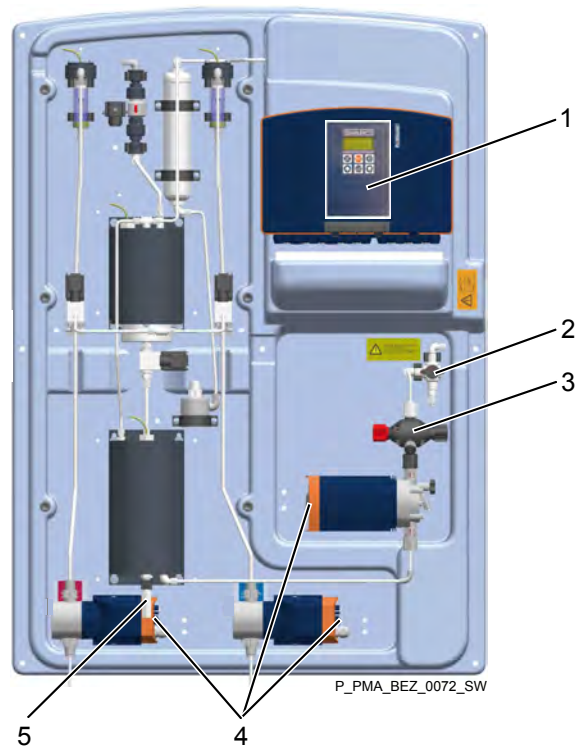
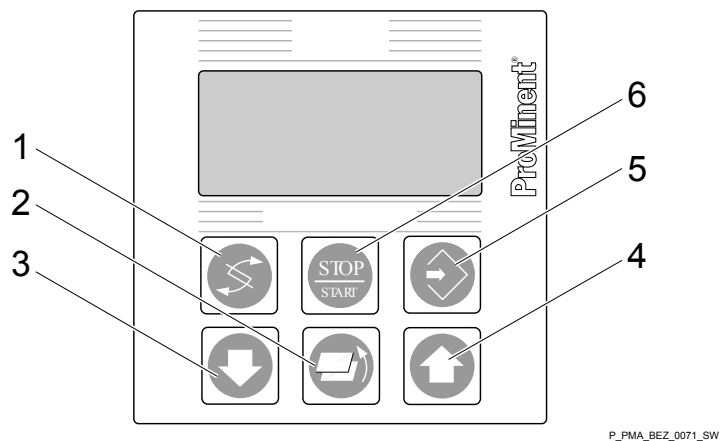

Fig. 13: Fully equipped CDLb 6

- 1 Control
- 2 3-way valve
- 3 Multifunctional valve (optional)
- 4 Stroke adjustment dials
- 5 Outlet valve

10.2 Key functions



No.	Name	Function
1	[Change]	To change within a menu level and to move from a changeable variable to another within a menu option.
2	[Jump back]	Back to the continuous display or to the start of the respective setting menu.
3	[Down]	To lower a displayed numerical value and to change the variables (flashing display).
4	[Up]	To increase a displayed numerical value and to change the variables (flashing display).
5	[Enter]	To apply, confirm or save a displayed value or status or To acknowledge an alarm.
6	[Start/Stop]	Start/Stop operation (press and hold for 3 s)

10.3 Operating menu, schematic

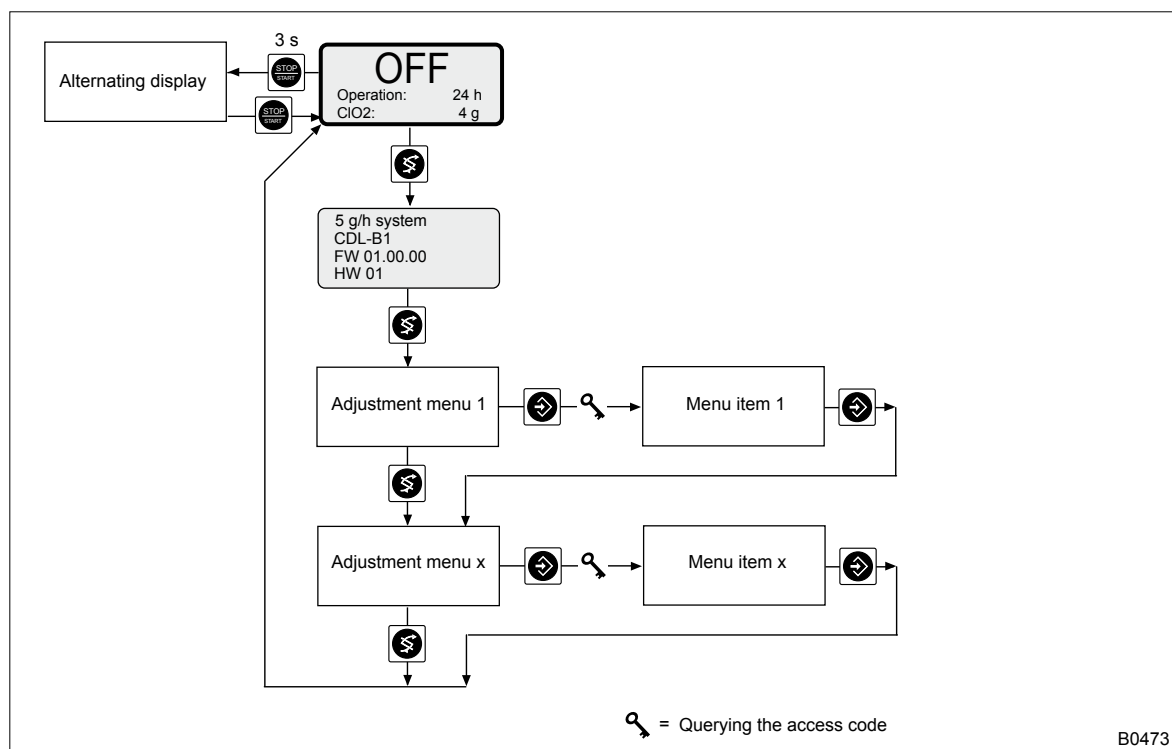

The alternating displays indicate:

- The time since the last maintenance
- The amount of ClO₂ produced since then or
- How old the existing ClO₂ solution is
- The remaining runtime in the 4 weeks prior to the end of the annual operating time instead of the operating hours and the produced ClO₂ quantity.



1 year = 8760 h.

The alternating display "OFF" appears as soon as metering is off.

The alternating display "Active" appears as soon as metering is on (and no signal is applied to the digital input). It is also indicated in the bottom row, if in the setting menu "Allocate digital input function?" has been set to "Shock metering", "Boost metering" or "Manual metering". If "Pause" was set, then the term "Pause" is displayed rather than "Active" as soon as during operation a signal is received at the digital input to set the metering to Pause.

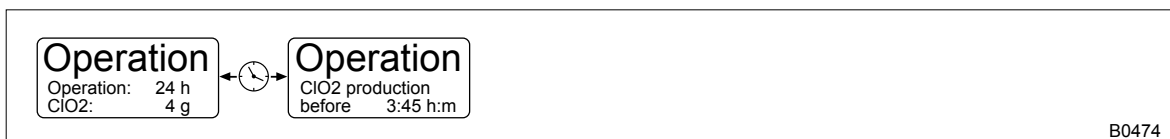

Fig. 14: Alternating display "Active" (default setting)

Explanation of the symbols of the alternating display

Symbol	Meaning	Comment
↓	Level warning HCl or NaClO ₂ drum	Place filled chemical drums ready
■	HCl or NaClO ₂ vessel full	
□	HCl or NaClO ₂ vessel not full	

To read off the hardware or software version or to adjust something on the control, the metering must be off ("Start/Stop key") - the LCD screen indicates "OFF" (then the control does not turn the pumps on and ignores all input signals).

After the "Change" key is pressed, the control switches to the Versions display or to the Setting menus display.

10.4 Operating menu, overview

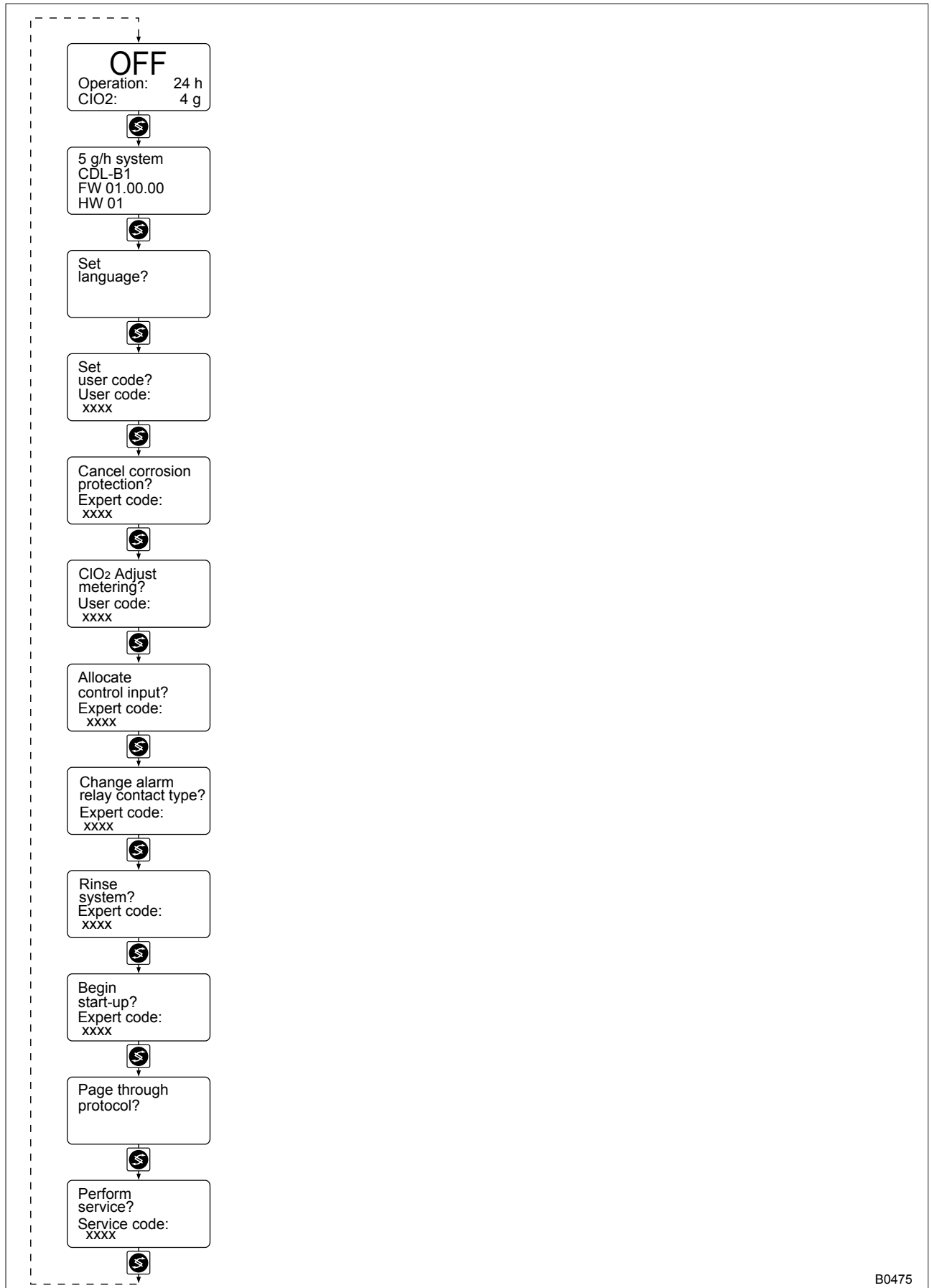

B0475

11 Start up

Safety notes



WARNING!

Only a ProMinent service technician or a competent person authorised by ProMinent may start up the Bello Zon® system.

This person must check whether the system is correctly assembled and installed.

The person must instruct the operator and the operating personnel.



CAUTION!

Warning of bursting lines

Never allow the metering pumps to pump against closed shut-off valves.



CAUTION!

Warning of unexpected startup

The chlorine dioxide Bello Zon® CDL system does not have an On/Off switch. It starts working as soon as power is supplied to the mains cable.

- Install an emergency stop switch outside the operating room.



The settings in the setting menu can be checked without an access code.

Requirements:

- Everything is correctly fitted and hydraulically and electrically installed.
- The diluting water is available at the "Diluting water" solenoid valve with a pressure of > 3 bar.
- No closed shut-off valve acts as a source of resistance for the metering pumps during work.
- The liquid downstream of the injection point(s) has sufficient pressure.
- The power plug of the Bello Zon® system is plugged into the mains socket.
- The component tanks are ready, but not yet connected.

11.1 Setting the language

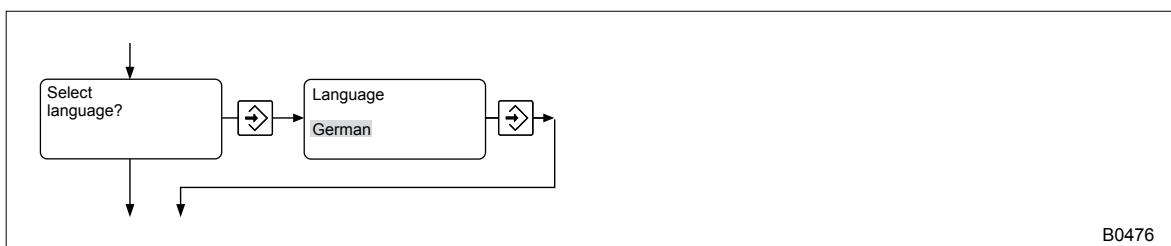

B0476

1. ➔ Change to the 'Select language?' setting menu by pressing the [Change] key and press the [ENTER] key.
2. ➔ Select the operating language ([arrow keys]) and press the [ENTER] key.

11.2 Changing the user code

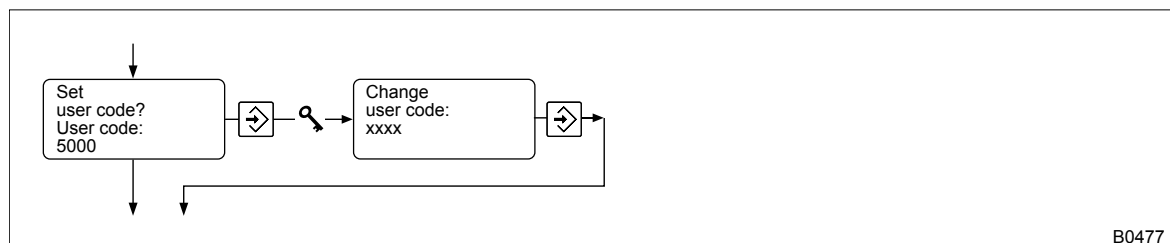

B0477

There are 3 different access codes:

Name	Enables ...	Access code
User code	Enables functions which trained personnel must use in their day-to-day work.	Factory setting: 5005, can be changed in "Settings" - "System info".
Expert code	Enables additional functions which technical experts must use in their day-to-day work.	Is only provided during technical expert training courses.
Service code	For basic settings during commissioning and maintenance.	Only known by suitably trained personnel such as customer service employees.

Most setting menus can only be opened with one of these access codes.

The 'user code' can be changed as desired in the 'Set user code?' setting menu. As supplied the 'user code' is: **5005**.



CAUTION!

Select a secure 'user code' so that it provides effective protection.

11.3 Cancelling corrosion protection

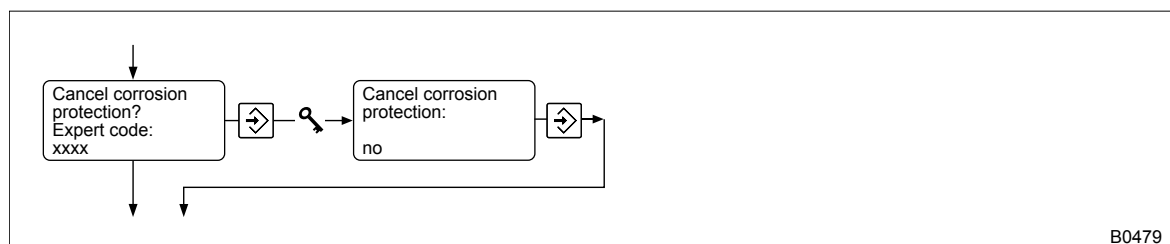

B0479

To prevent corrosion due to a temporary overdosing of acidic ClO₂ solution, the control only accepts ClO₂ setpoint concentrations up to a certain maximum setpoint. This is dependent on the set contact gap of the water meter. Consequently the control only permits a maximum of 2 metering strokes of the ClO₂ pump per incoming contact signal of the water meter.

This limit can be cancelled for relevant applications in the 'Cancel corrosion protection' setting menu.



WARNING!

Warning of toxic ClO₂ solution

If a mist forms, hydraulic components can quickly corrode through and toxic ClO₂ solution can escape.

- If corrosion protection is cancelled, always check that ClO₂ metering remains constant.

11.4 Setting the ClO₂ metering

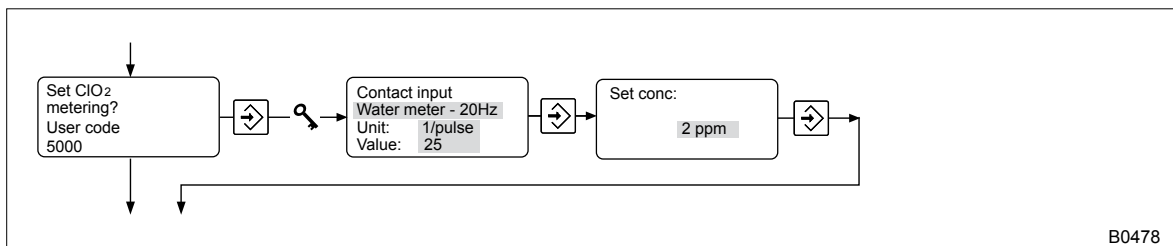

It is only possible to enter settings with a 'User code'.

1. ➤ Switch to 'CHANGE' in the [Adjust ClO₂ metering] setting menu and press [ENTER].
2. ➤ Enter the 'User code' and press [ENTER].
3. ➤ Select the type of water meter in the first menu item (via the maximum frequency 20 Hz or 5 kHz) and enter the contact gap of the water meter ([arrow keys]) (refer also to the "Installation" chapter under "Water Meter").

It is also possible to select 'External' .

Then the ClO₂ metering pump performs a stroke (1:1) for each incoming contact.

4. ➤ Save the value with [ENTER].
5. ➤ In the next menu item, enter the required 'Setpoint concentration' of ClO₂ in the water to be treated ([arrow keys]).



This is an approximate value that would be exact with an 80 % stroke length at the ClO₂ pump and 5 bar pressure in the line containing the water to be treated.

6. ➤ Save the value with [ENTER].
7. ➤ Now you can start metering - to do so, press [Esc] to switch to the alternating display and press [Start/Stop].

**WARNING!****Warning of too-low ClO₂ concentration**

A depletion effect can reduce the ClO₂ concentration in the treated water by too much.

- Check the ClO₂ value in the treated water, correct if necessary and record the value in the operating log after the Bello Zon[®] system has been metering for a certain time.

**CAUTION!****Risk of corrosion damage**

A too low pH value of the treated water may lead to corrosion damage throughout the installation.

- Check the pH value in the treated water, correct if necessary and record the value in the operating log after the Bello Zon[®] system has been metering for a certain time.
- For pH values below 6.5 enter pH increasing additive.

11.5 Allocating the digital input

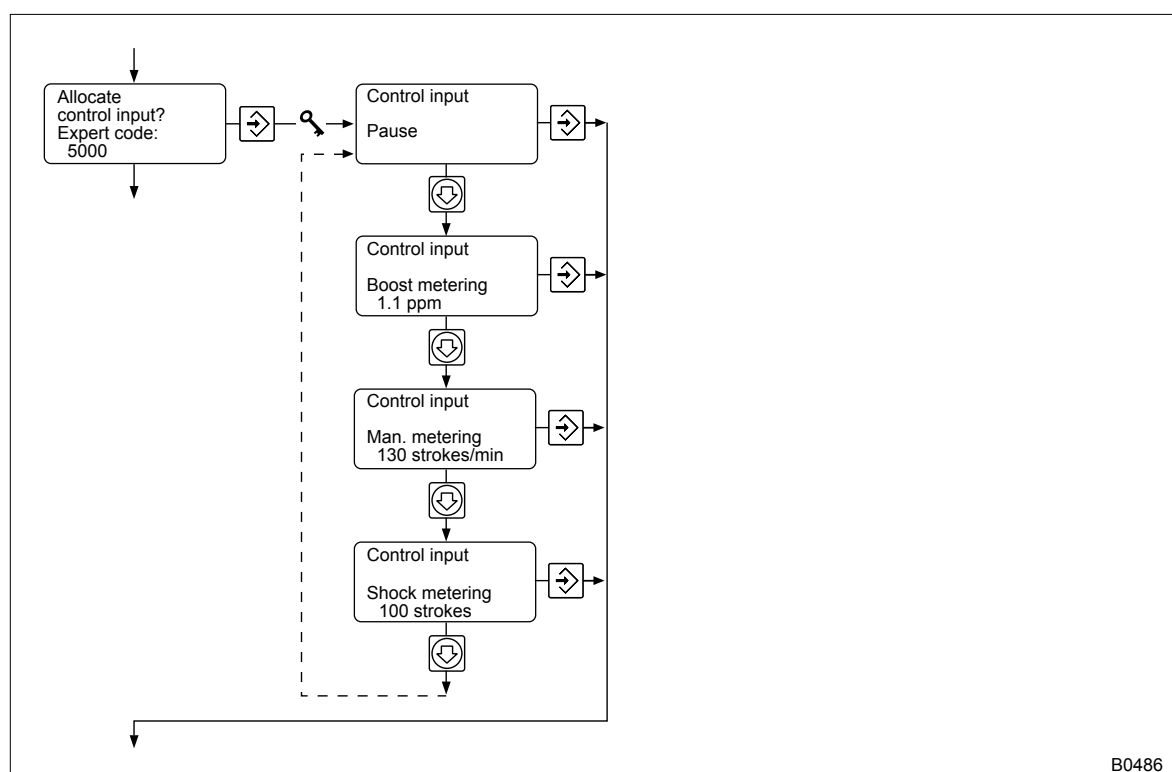

B0486



CAUTION!

- When a switch is connected to terminals XK8:1 - XK8:2, pull off the jumper between these two terminals. Otherwise the system will not stop when 'Pause' is pressed. The 'Shock metering', 'Boost metering' and 'Manual metering' operating modes cannot be enabled with the other settings.
- The system does not meter when 'Pause' is pressed if no switch is connected to terminals XK8:1 - XK8:2 and they are not bridged. 'Shock metering', 'Boost metering' and 'Manual metering' operating modes are permanently enabled with the other settings.

A signal to the control input may, dependent on the setting, interrupt normal mode with one of 4 different operating modes:

- Pause
- Shock metering
- Boost metering
- Manual metering

When 'Pause' is pressed, an open contact causes ClO₂ metering to be interrupted – otherwise the system continues to operate as normal.

With 'Shock metering', an individual contact signal (close) causes the ClO₂ pump to operate at maximum stroke rate for a number of strokes that can be set here.

With 'Boost metering', a closed contact causes the system to meter an increased target concentration of ClO₂. The increased target concentration can be set here.

With 'Manual metering', a closed contact causes the ClO₂ pump to operate at a stroke rate that can be set here.

The alternating displays indicate these operating modes in clear text.

11.6 Configuring alarm relay contact types

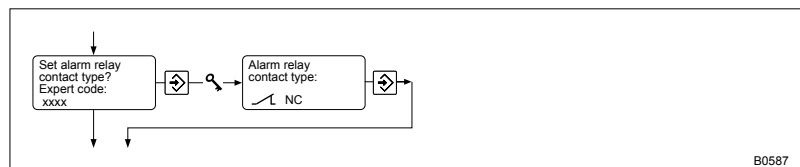

➔ Configuring how the alarm relay is to behave.

Setting	Normal mode	Fault
NC (normally closed)*	closed	open
NO (normally open)	open	closed

* recommended

11.7 Installing chemical drums



1. ➔ The LCD screen must display 'OFF', if necessary press the [Start/Stop] key.
2. ➔ Place the new chemical drums beneath the system.

Observe the colour code
Acid = red, left; chlorite = blue, right!

3. ➔ Screw the covers with the correct suction lances on to the chemical drums.
4. ➔ Next the mixer vessel and the storage tank must be filled and the metering pumps bled. This part of commissioning is menu-controlled, see the following chapter.

11.8 Carrying out commissioning

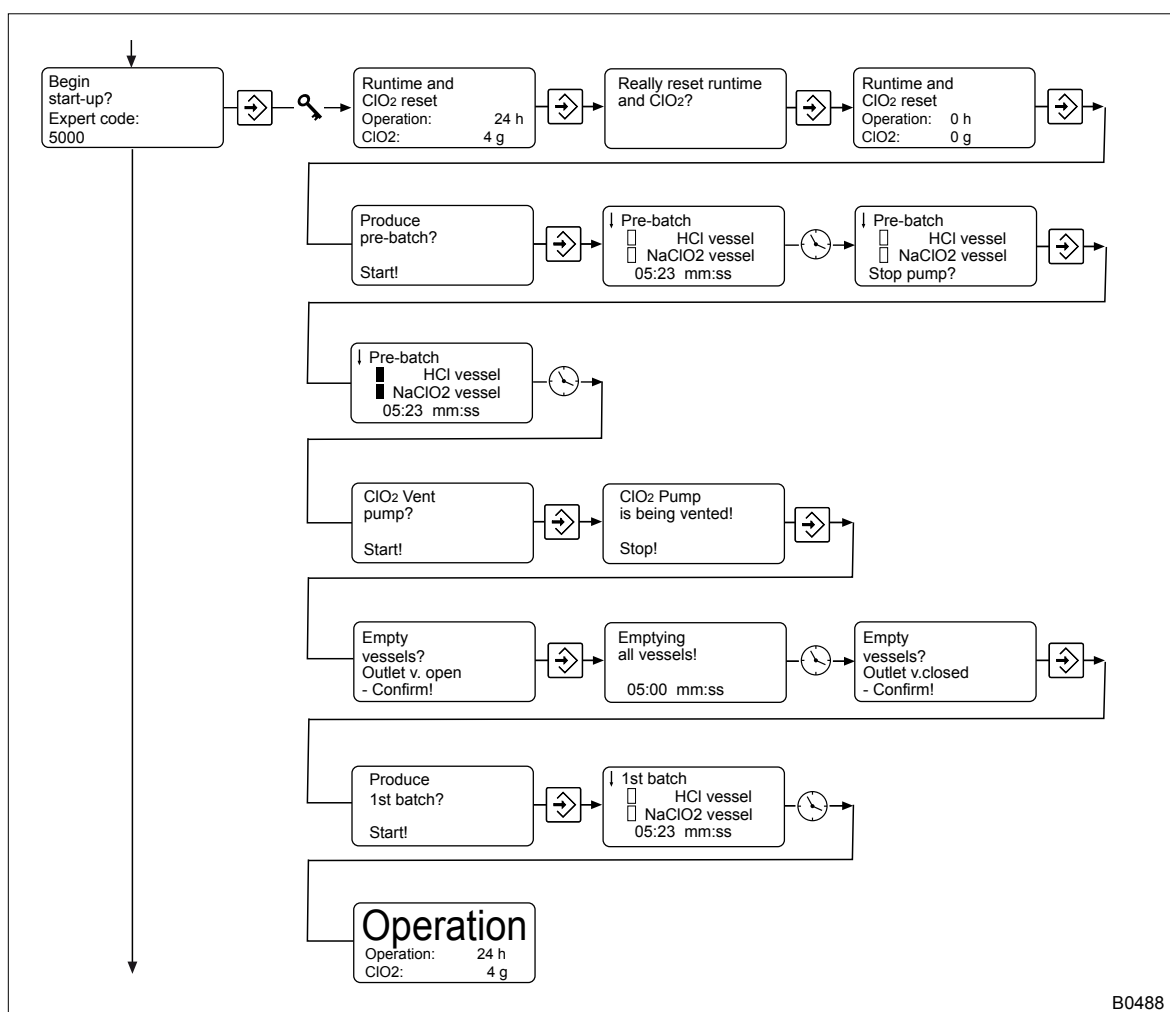

B0488

Explanation of the symbols in the menu items "1st Batch"

Symbol	Meaning		Comment
↑	First row:	Pre-storage vessel full	
↓	First row:	Pre-storage vessel empty	

Symbol	Meaning		Comment
↓	Second/third row:	Level warning HCl or NaClO ₂ drum	Place filled chemical drums ready
■	HCl or NaClO ₂ measuring vessel full		
□	HCl or NaClO ₂ measuring vessel not full		

1. ➤ Check whether the outlet valve at the bottom on the inside of the pre-storage vessel is closed.
2. ➤ Change to the 'Begin commissioning?' setting menu by pressing the [Change] key and press the [ENTER] key.
3. ➤ Enter the access code ([Arrow Keys]) and press [Enter].



It is possible to jump from one display to an underlying display by pressing the [CHANGE] key. This prevents resetting of the operating time.

4. ➤ If the 'Runtime' and der 'ClO₂ meter' are to be reset, run through the submenu 'Runtime and ClO₂ meter'.
 - ⇒ The meters are reset and the submenu 'Pre-batch' appears.
5. ➤ Confirm 'Produce pre-batch' by pressing the [ENTER] key.
 - ⇒ The control supplies the diluting water to the mixer vessel.

The metering pumps fill the measuring vessels.



In an emergency, the metering pumps can be stopped with the [ENTER] key.

The solenoid valves empty the measuring vessels into the mixer vessel.

The control fills the mixer vessel with a powerful water jet, thereby simultaneous mixing the ClO₂ solution.

Without a reaction time, the control empties the mixer vessel into the storage tank.

The 'ClO₂ pump' sub-menu appears.



To bleed the ClO₂ pump, use the separate 3-way valve in the metering line!

Do not remove the plug in the bleed connector of the ClO₂ pump!

6. ➤ Remove the plug in the bleed connector of the 3-way valve.
7. ➤ Connect a PVC tube 6 x 4 mm to the bleed connector.
8. ➤ Lead the PVC tube into a 10 l bucket in which a ClO₂ removal agent has been mixed, see the "Accessories" chapter.

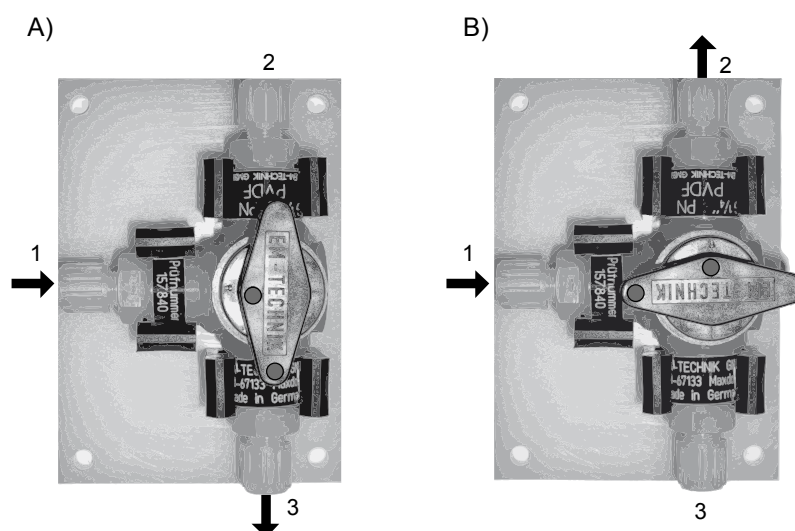

Fig. 15: 3-way valve: A) "Bleed" position; B) "Operation" position

- 1 From Bello Zon®
- 2 Point of injection
- 3 Collecting vessel

9. Turn the 3-way valve to the "Bleed" position - see Fig. 15 A)
10. Start the ClO₂ pump with [ENTER].
11. Stop the ClO₂ pump with [ENTER] as soon as it and the metering line have been bled.



CAUTION!

Always refit the plug in the bleed connector of the 3-way valve.

⇒ The submenu 'Vessels' appears.

12. To empty the pre-storage vessel; first remove the plug in the outlet valve.
13. Connect an approximately 1 m long PTFE hose to the outlet valve at the bottom of the inside of the pre-storage vessel.
14. Guide the PVC tube into the 10 l bucket containing the ClO₂ removal agent. The bucket should be positioned directly under the system on the floor.
15. Open the outlet valve at the bottom of the inside of the pre-storage vessel - turn the black ring to the left by approximately 1 turn.
16. Confirm the action by pressing the [ENTER] key and wait.

⇒ The next menu item appears.
17. Once no more liquid flows, close the outlet valve at the bottom of the inside of the pre-storage vessel - turn the black ring to the right by approximately 1 turn.



CAUTION!

Always refit the outlet valve's plug.

18. Confirm the action with [ENTER] and wait until the menu item '1st Batch' appears.
19. Remove the PVC tube from the 3-way valve and fit the plug.
20. Set the 3-way valve to "Operate".

- 21.** ▶ Empty the 10 l bucket into the discharge gutter and rinse away with plenty of water.
- 22.** ▶ To start the '1st batch', press [ENTER].
- ⇒ The control supplies the diluting water to the mixer vessel.
- The pumps pump acid and chlorite into the mixer vessel.
- The solenoid valves empty the measuring vessels into the mixer vessel.
- After a short reaction time, the control fills the mixer vessel with a powerful water jet, thereby simultaneous mixing the ClO₂ solution.
- Then the control empties the mixer vessel into the storage tank and initiates the next batch.
- Thereafter the ClO₂ solution is ready - the alternating display 'Active' appears.
- Commissioning of the CDLb is now complete.**



WARNING!

Warning of too-low ClO₂ concentration

A depletion effect can reduce the ClO₂ concentration in the treated water by too much.

- Check the ClO₂ value in the treated water, correct if necessary and record the value in the operating log after the Bello Zon[®] system has been metering for a certain time.



CAUTION!

Risk of corrosion damage

A too low pH value of the treated water may lead to corrosion damage throughout the installation.

- Check the pH value in the treated water, correct if necessary and record the value in the operating log after the Bello Zon[®] system has been metering for a certain time.
- For pH values below 6.5 enter pH increasing additive.

12 Operation

**WARNING!**

At no operating status may the maximum permissible operating pressure for the system be exceeded.

**WARNING!**

The entire installation should remain leak-tight when operating at maximum operating pressure.

12.1 Changing the chemical drums

**WARNING!****Danger of explosion**

If the two chemicals hydrochloric acid and sodium chlorite come together, toxic ClO_2 gas forms almost instantaneously and this can then explosively decompose.

- The two components hydrochloric acid (HCl) and sodium chlorite (NaClO_2) must never be brought into contact except in the mixer vessel.

**WARNING!****Warning of toxic ClO_2 gas**

- Only trained personnel may change the chemical drums.
- Observe the colour code.
Red stands for acid (HCl, left),
blue for chlorite (NaClO_2 , right).
- Never pour chemicals from chemical canisters back into the drums or pour them together.
- Never place both suction lances in the same vessel.
- To do so ensure that the "Acid" suction lance is installed in the "Acid" chemical drum (observe colour-coded labels) and the "Chlorite" suction lance is installed in the "Chlorite" chemical drum.

**WARNING!**

Only use Bello Zon[®] chlorite. Never operate the chlorine dioxide system with undiluted sodium chlorite.

Otherwise ClO_2 concentrations are formed for which the system is not designed.

**WARNING!**

Only use Bello Zon[®] chlorite. Never operate the chlorine dioxide system with undiluted sodium chlorite.

Otherwise, chlorite concentrations are formed in the treated water that are harmful to human health.

**WARNING!**

Never interchange sodium chlorite (NaClO_2) with sodium-calcium hypochlorite (sodium hypochlorite, NaOCl). Only use Bello Zon[®] chlorite.

**WARNING!****Warning against leaks**

Technically impure hydrochloric acid can contain organic chlorine compounds that strongly corrode the seals and render PVC components brittle.

- Only use Bello Zon[®] acid.

1. ➤ The LCD screen must display 'OFF', if necessary press the [Start/Stop] key.
2. ➤ Carefully remove each suction lance from its chemical drum- raise slowly while keeping vertical.
3. ➤ Place each suction lance in its own bucket full with clean water (this prevents the suction lances from running dry).
4. ➤ Close the empty chemical drums and ensure they are disposed of properly.
5. ➤ Place the new chemical drums beneath the system - acid = red, left; chlorite = blue, right!
6. ➤ Screw the covers with the correct suction lances on to the chemical drums.
7. ➤ Check the suction lines for air bubbles and vent the system if air bubbles exist.
8. ➤ Start operation using the [Start/Stop] key.

12.2 Flush system

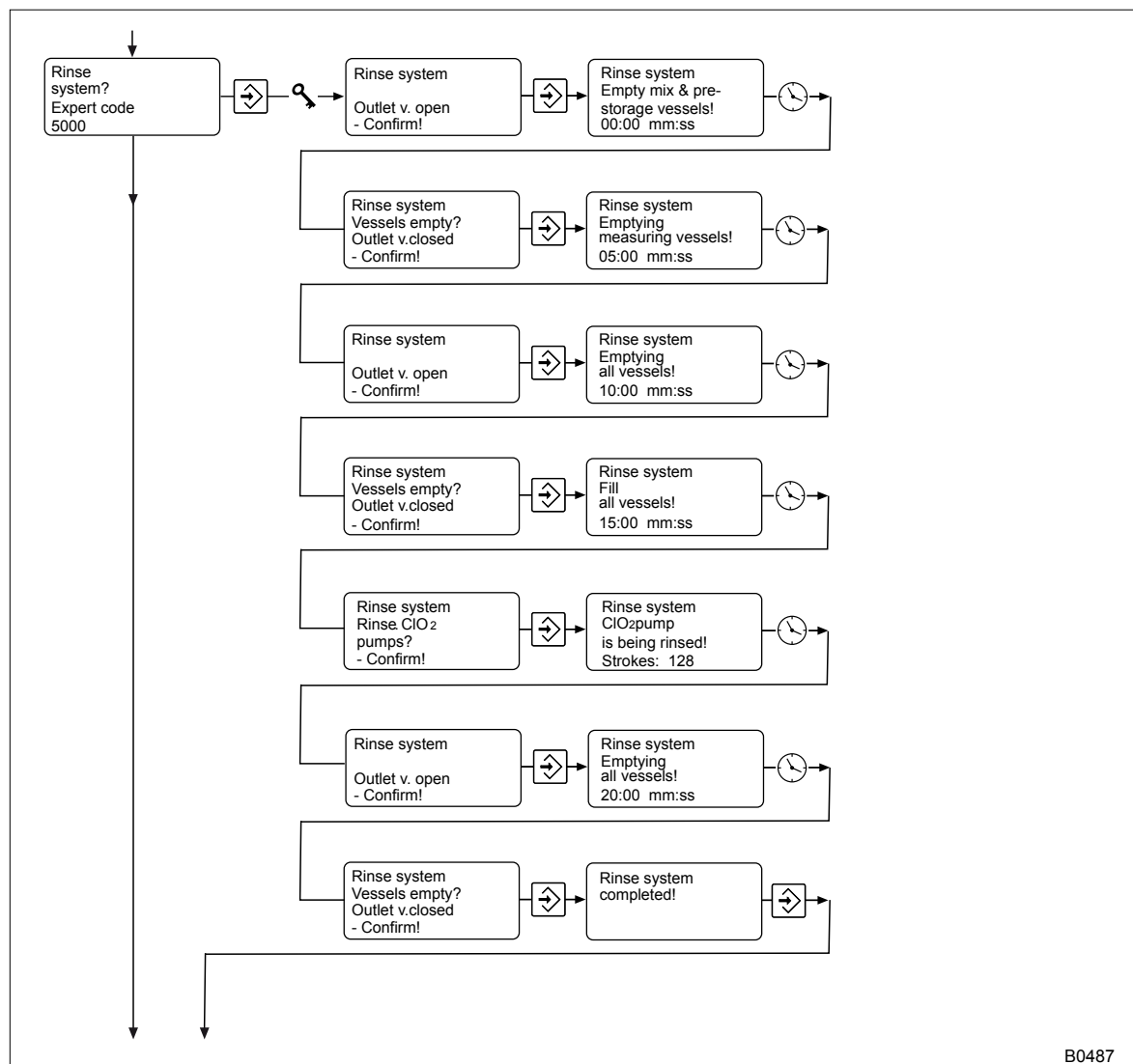

The system must be rinsed through ...:

- after an operating malfunction
- if the ClO₂ solution is too old
- before carrying out maintenance on it
- before it is placed out of service.

1. ➤ Place each of the suction lances in its own bucket full with clean water.
2. ➤ Remove the plug in the bleed connector of the 3-way valve.
3. ➤ Connect a PTFE hose to the bleed cock.
4. ➤ Lead the PVC tube into a 10 l bucket in which a ClO₂ removal agent has been mixed, see the "Accessories" chapter.

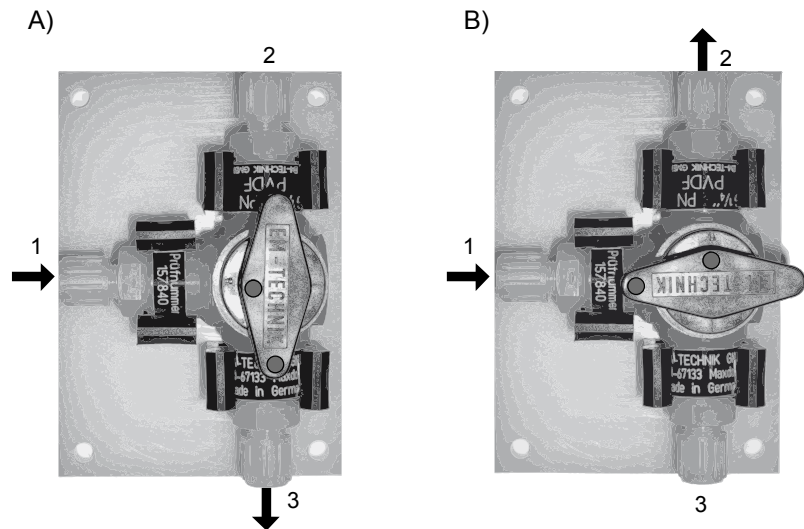

Fig. 16: 3-way valve: A) "Bleed" position; B) "Operation" position

- 1 From Bello Zon®
- 2 Point of injection
- 3 Collecting vessel

5. ➤ Set the 3-way valve to "Bleed", see Fig. 16.
6. ➤ Connect an approximately 1 m long PTFE hose to the outlet valve at the bottom of the inside of the pre-storage vessel.
7. ➤ Guide the PVC tube into the 10 l bucket containing the ClO₂ removal agent. The bucket should be positioned directly under the system on the floor.
8. ➤ Change to the setting menu 'Begin commissioning?' by pressing the [CHANGE] key and press the [ENTER] key.
9. ➤ Enter the access code and press the [ENTER] key.
 - ⇒ 'Outlet valve open' appears
10. ➤ Open the outlet valve on the black ring by turning approximately 1 turn in an anticlockwise direction and press [ENTER].
 - ⇒ 'Mixer & pre-storage vessel emptying!' appears and the control empties the mixer vessel.
11. ➤ As soon as 'Vessels empty?' appears and no more liquid flows out, close the outlet valve on the black ring by turning approximately 1 turn in a clockwise direction and press [ENTER].
 - ⇒ 'Measuring vessels emptying!' appears and the control fills the mixer vessel in 2 steps.
12. ➤ As soon as 'Outlet valve open' appears, open the outlet valve on the black ring by turning approximately 1 turn in a clockwise direction and press [ENTER].
 - ⇒ 'All vessels emptying!' appears and the control empties the mixer vessel into the pre-storage vessel.
13. ➤ As soon as 'Vessels empty?' appears and no more liquid runs out, close the outlet valve and press [ENTER].
 - ⇒ 'All vessels filling!' appears and the control fills all vessels.
14. ➤ As soon as 'ClO₂ pumps rinsing?' appears, set the 3-way valve to rinse, see Fig. Fig. 16 and press [ENTER].
 - ⇒ 'ClO₂ pump rinsing!' appears and the control allows the ClO₂ pump to work.
15. ➤ As soon as 'Outlet vale open' appears and the ClO₂ pump remains stationary, set the 3-way valve to "Operate", see Fig. Fig. 16 and press [ENTER].
 - ⇒ 'All vessels emptying!' appears and the control empties all ves-

16. As soon as 'Vessels empty?' appears and no more liquid flows out, close the outlet valve at the black ring by turning approximately 1 turn in a clockwise direction and press [ENTER].
 ⇒ 'Rinse system is ended!' appears.
17. Remove the PVC tube from the outlet valve and fit the plug.
18. Remove the PVC tube from the 3-way valve and fit the plug.
19. Check that the 3-way valve is positioned at "Operation".
20. Carefully insert the acid suction lance in the red "acid" vessel and secure.
21. Carefully insert the chlorite suction lance in the blue "chlorite" vessel and secure.
22. Empty the water buckets one after the other into a drain and flush with plenty of water between buckets.
23. Press [ENTER] to exit the setting menu 'Rinse system?' and using the [CHANGE] key, change to the 'OFF' display.



WARNING!

Toxic ClO₂ can escape

The system must not operate without the plugs as otherwise toxic ClO₂ solution can escape.

- Check whether the plugs have been installed at the outlet valve and the 3-way valve



WARNING!

Toxic chemicals can escape

If the 3-way valve is incorrectly positioned, the pumps could cause the piping and tubing to burst and toxic chemicals could escape

- Check that the 3-way valve is positioned at "Operation"

12.3 Paging through the protocol

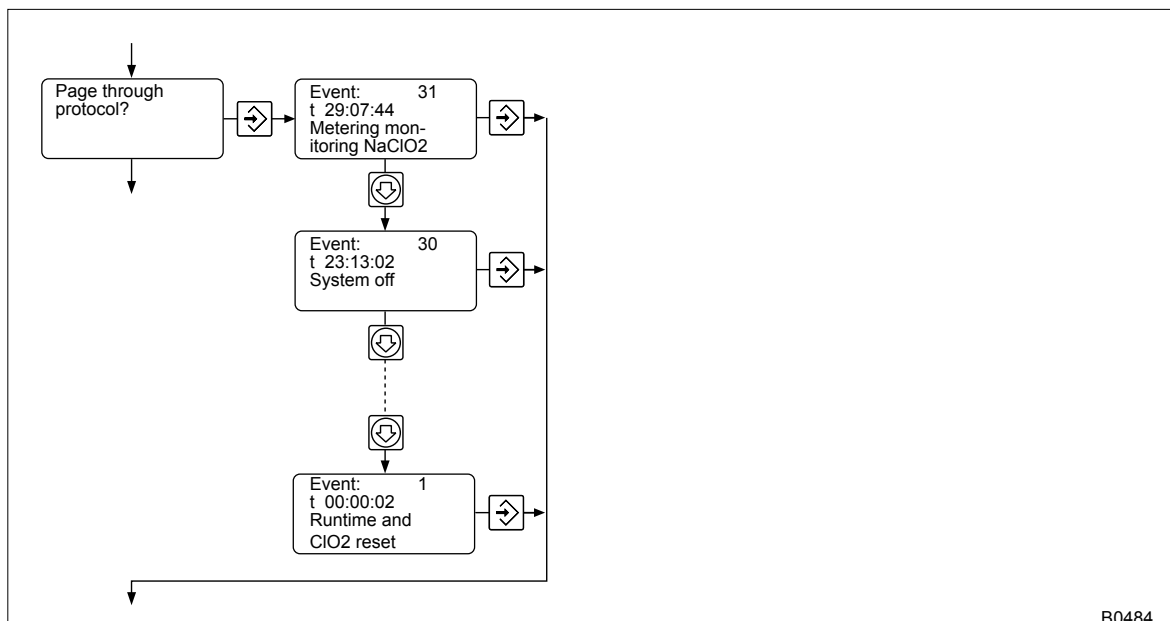

B0484

The protocol function records all important events in the control of the Bello Zon® CDLb system, in a power-failure secure manner, see Tab. *on page 49*. It numbers the events sequentially and specifies the time of the event. If there is a power failure, the internal clock continues to run.

The protocol function starts with the first commissioning in the factory.

The control counts the time points "t" of the new events starting from the last resetting of the operating time (in hours : minutes : seconds). In general this is the date of the last maintenance.

The control stores old events when resetting the operating time. However, they keep their old time points "t".

Paging through the protocol is undertaken using the *[Arrow keys]*.

Events that are recorded in the protocol

Event	Remark
System on	Via <i>[START/STOP]</i> key
System off	Via <i>[START/STOP]</i> key
Voltage supply on	-
Runtime and ClO ₂ reset	See the "Start-up" chapter
Flush system	See chapter "Rinse system" or "Decommissioning"
1. Batch	Produce the 1st Batch
Pre-batch	First fill of the two vessels
All error messages	See "Troubleshooting" chapter

12.4 Perform service

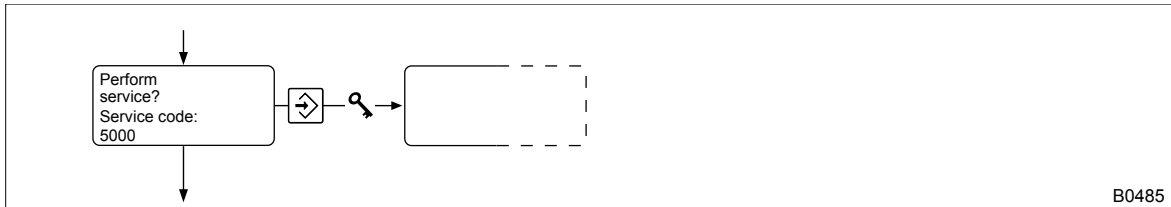

This setting menu is only for service teams authorised by ProMinent - see "Operating instructions Chlorine dioxide systems Bello Zon® Type CDLb, service instructions".

13 Maintenance

Weekly

The Bello Zon® CDLb must be inspected at least weekly by a trained person. This must include checking all metering pumps and tube connections for leak-tightness. In the event of leaks, inform ProMinent's authorised service department and switch off the system!

Annually

Carry out a complete annual maintenance according to the service menu - see chapter "Operation" - "Perform service".



WARNING!

Only ProMinent's authorised service department is approved to repair the Bello Zon® CDL system.

Maintenance kits, order numbers



Keep a maintenance kit in stock!

Annual maintenance cycle

System type:	CDLb 06	CDLb 12	CDLb 22	CDLb 55
"With internal pre-storage vessel, pump and multifunctional valve"	1044484	1044484	1044501	1044509
"With internal pre-storage vessel and pump"	1044495	1044495	1044503	1044511
"With internal pre-storage vessel"	1044497	1044497	1044505	1044513

3-year maintenance cycle

Maintenance kit	CDLb 06	CDLb 12	CDLb 22	CDLb 55
"With internal pre-storage vessel, pump and multifunctional valve"	1044494	1044494	1044502	1044510
"With internal pre-storage vessel and pump"	1044496	1044496	1044504	1044512
"With internal pre-storage vessel"	1044498	1044498	1044506	1044514

14 Repairs



WARNING!

Only the fuses in the control can be replaced by the operator's qualified employees! All other repair work on the Bello Zon® CDL system may only be performed by ProMinent's authorised service.



WARNING!

Only qualified personnel may open the controller



WARNING!

Before opening the device, ensure that the control is not live and cannot be switched on!



WARNING!

It starts working as soon as power is supplied to the mains cable. The chlorine dioxide Bello Zon® CDLb does not have an On/Off switch.

Fuses: Micro fuse 5 x 20 mm

Fuse	Features	Part no.
F1 (control):	for 100...230 V: 0.4 A super slow	712060
F2 (pumps, solenoid valves):	for 100...230 V: 3.15 A super slow	712069



The fuses are contained in the control's terminal box to the right, each in a fuse holder with a bayonet coupling.

15 Troubleshooting

Operating indicator

The relay "Operating indicator" has de-energized.

The system is not ready for operation, it:

- is in a fault state
- is switched off
- has interrupted metering due to temporarily too high ClO₂ extraction.

Warning messages

The "Warning alert" relay has energized.

Fault description	Cause	Remedy
↓ HCl or ↓ NaClO ₂	Lack of chemical (1st stage level switch)	Prepare to change the chemical drum.
Remaining run time = xxx h	Put briefly, it is a year since the last maintenance (1 year = 8760 h). The control warns 4 weeks in advance (4 weeks = 672 h).	Arrange immediately for ProMinent Service to carry out maintenance.

Fault alerts

The "Alarm" relay has switched, the "Error" appears in the operating indicator, the system switches off.



All error messages must be acknowledged.

For some error messages an expert code is required - indicated in the following table by "#".

For some error messages a user code is required - indicated in the following table by "##".

Fault description	Cause	Remedy
HCl vessel empty	Hydrochloric acid vessel is empty	Replacing both chemical drums - refer to the "Operation" chapter.
NaClO ₂ vessel empty	Chlorite vessel is empty	Replacing both chemical drums - refer to the "Operation" chapter.
Water flow too high	The mixer vessel was filled with water too early.	Reduce the pressure of the diluting water.
Water flow too low	The mixer vessel was filled with water too late.	Check the pressure of the diluting water (pipe blocked?).
Extraction too high	Chlorine dioxide extraction is higher than can currently be made-up.	Check the system for leaks. Check the maximum flow in the water meter (IDM) and reduce if necessary. Check the process control. Check the system layout.
Operating time expired	The system has been running for 1 year.	Instigate system maintenance immediately!
External error	A device that is connected to the input "External fault", reports a fault (e.g. flow meter bypass or ClO ₂ measuring point)	Clear the fault.

All other faults

Please contact the responsible ProMinent branch or representative!



In the event of a power failure, the control stores the parameters and the status of the Bello Zor® CDLb system.

After a power failure during normal operation, the Bello Zor® CDLb continues working as if this interruption had not occurred.

16 Decommissioning



WARNING!

Toxic ClO₂ gas can escape

- Never pour the contents of the chemical drums together.
- Never place both suction lances together or one after the other in the same bucket.



WARNING!

Corrosive liquids may escape

Do not inadvertently interchange the different valves

16.1 For a short period

Only take the Bello Zon® CDLb system out of service for short periods:

- ➔ Press key [Start/Stop] key.
- ⇒ 'OFF' appears.

The power supply to the system control must not be interrupted during this period.

16.2 Over longer periods

chlorine dioxide (ClO₂) is an unstable compound, which decomposes over time.

Therefore the Bello Zon® system must be rinsed through with water if it is to be taken out of service for a certain period:

Application	Temperature	Decomposition time, approx.
Potable water	15 °C	2 days
Water with foodstuff contact		
Process water	20 °C	10 days
Washing water		
Cooling water		
Backwash water	25 °C	2 days

- ➔ Flush the system with water - see "Operation" "Flushing the system".

17 Disposal

Safety notes



WARNING!

The Bello Zon[®] system could still contain hydrochloric acid (HCl), sodium chlorite (NaClO₂) and chlorine dioxide (ClO₂).

- The entire Bello Zon[®] system must be thoroughly rinsed through with water - see chapter 12 "Decommissioning".
- If necessary, also rinse the empty chemical drums.

Active carbon filter

The active carbon filter is contained inside the system, see Fig. 5, item 11.

Battery

The battery is clamped in a holder on a PCB in the control.

1. ➤ To access the battery, unscrew the four securing screws at the front on the housing upper section and take the housing upper section off from the housing lower section.
2. ➤ To remove the battery from the holder, press on the flap of the holder - see Fig. below.

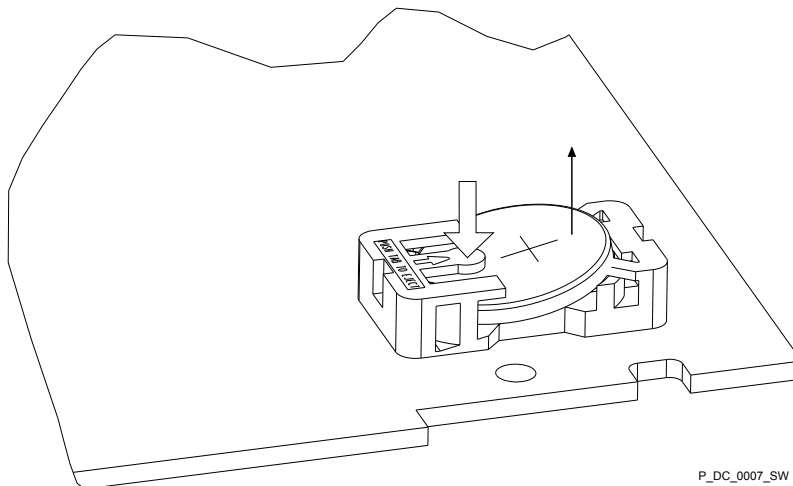

P_DC_0007_SW

18 Technical data CDLb

General

CDLb	6 g/h	12 g/h	22 g/h	55 g/h
Power:	6 g/h	12 g/h	22 g/h	55 g/h
Diluting water:	3-6 bar	3-6 bar	3-6 bar	3-6 bar
Concentration ClO ₂ stock solution:	1000 ppm	2000 ppm	2000 ppm	2000 ppm
Concentration ClO ₂ metering pump:	8 l/h at 7 bar	8 l/h at 7 bar	13 l/h at 7 bar	30 l/h at 7 bar

Weight (without packaging):

Weight, panel-mounted system in kg, approx.

Type	6 g/h	12 g/h	22 g/h	55 g/h
Empty weight	41	42	46	75

Ambient conditions

Variable	Value	Comment
Storage temperature:	5 ... 50 °C	
Temperature during operation:	10 ... 40 °C	
Diluting water temperature:	10 ... 30 °C	
Temperature of water to be treated:	5 ... 60 °C	Dependent on the material of the point of injection and its pressure, see injection point documentation
Max. relative humidity:	92 %,	non-condensing
Degree of protection:	IP 65	Value for the control, only if the seal is correctly fitted and the interface cover closed.
Miscellaneous:		Protect against sunlight

Materials

Bracket:	PE
Canopy:	PE
Fittings:	Stainless steel
Mixer vessel:	PVC / PVDF
Internal storage tank:	PVC
Control housing:	PPE GF10
Membrane keypad:	Polyester PET membrane
Pump housing:	PPE, fibreglass-reinforced
Pump liquid ends:	PP, PVDF

Technical data, electrical

System

Power supply

Data	Value	Unit
Nominal voltage, $\pm 10\%$	230 or 115	V
Mains supply frequency	50 / 60	Hz
Socket fuse	16	A

Control

Fuses

Description	Type	Supplied ...	Terminals	Part no.
F1	0.4 ATT	Control	XP	712060
F2	3.15 ATT	pumps, solenoid valves		712069
Micro fuse 5 x 20 mm				

Inputs

Digital input for contact water meter with reed-switch or Namur water meter with pulse width > 15 ms (XK1:3, 4):

Frequency range: 0.25 ... 20 Hz

Inputs: based on DIN 19 234 (Namur)

Supplied open circuit voltage: 8.2 V

Switch point: 4 k Ω

Contact input for contact water meter with Hall sensor or IDM with frequency output (XK1:2 and XK1:3):

Hall sensor:

Integrated supply voltage: +5 V, 10 mA

Contact gap: 0.1 ... 10 l / pulse

IDM (open collector):

Frequency range: 10 ... 10000 Hz

Pulse width: > 20 μ s

Contact inputs (XK2 ... XK7):

for contacts or switching transistors:

Open circuit voltage: 12 V \pm 1 V

Short circuit current: 5 mA

Contact: open, R > 100 k Ω

Contact: closed, R > 1 k Ω

Outputs

Switching outputs

Alarm relay (XR2:2 and XR2:1):

Type of contact: N/C or N/O (adjustable via Menu)

Load capacity: 250 V AC / 3 A / 100 VA

Warning relay (XR1:1 and XR2:1):

Type of contact: N/O

Load capacity: 250 V AC / 3 A / 100 VA

Operating indicator relay (XR1:2 and XR2:1):

Type of contact: N/O

Load capacity: 250 V AC / 3 A / 100 VA

19 Accessories

Chemicals

Accessories	Part no.
Bello Zon® acid in 25 l single-use drum	1027594
Bello Zon® chlorite in 25 l single-use drum	1027595
Chemical additives for removal of chlorine dioxide during system flushing	1029256

Collecting pan

Accessories	Part no.
Collecting pan for each 25 l chemical drum	1026744

Point of injection, Bello Zon®

Corrosion-resistant point of injection for Bello Zon® CDL from PVC-U, PVDF and PTFE with integral mixer elements and maintenance-free injection valve made of PVDF;

Max. permissible pressure at various temperatures - see Chap. "Installation" - "Point of injection"

Flange connection	Material	Flow	Fitting length	Order no.
		m ³ /h		
DN50	PVC-U	15	450	1027611
DN65	"	25	400	1026490
DN80	"	35	400	1027612
DN100	"	50	470	1034693
DN125	"	90	550	1047692
DN150	"	160	680	1047693
DN65	PVC-C	25	400	1029326
DN80	"	35	400	1029327

External storage module

Accessories	Part no.
External storage module	1042700

Instrumentation

Accessories	Part no.
DULCOMETER® D1C or D2c for online monitoring of the limit values for chlorine dioxide, chlorite and pH value	(upon request)
Manual photometer DULCOTEST® DT4 for control measurements of chlorine dioxide and chlorite	1022736
Manual photometer DULCOTEST® DT1 for control measurements of chlorine dioxide and pH value	1003473

Multifunctional valve

Accessories	Part no.
Multifunctional valve with wall bracket type MFV-DK Size I, 16 bar, with wall bracket, hose connector 10x8	1027652

20 EC Declaration of Conformity

In accordance with DIRECTIVE 2006/42/EC OF THE EUROPEAN PARLIAMENT AND OF THE COUNCIL, Appendix I, BASIC HEALTH AND SAFETY REQUIREMENTS, section 1.7.4.2. C.

We,

- ProMinent GmbH
- Im Schuhmachergewann 5 - 11
- D - 69123 Heidelberg,

hereby declare that the product specified in the following, complies with the relevant basic health and safety requirements of the EC Directive, on the basis of its functional concept and design and in the version distributed by us. This declaration loses its validity in the event of a modification to the product not agreed with us.

Extract from the EC Declaration of Conformity

Designation of the product:	Bello Zon® chlorine dioxide generation system
Product type:	CDLb...
Serial number:	refer to nameplate on the device
Relevant EC directives:	EC Machinery Directive (2006/42/EC) EC EMC Directive (2004/108/EC) Compliance with the protection targets of the Low Voltage Directive (2006/95/EC) according to Appendix I, No. 1.5.1 of the Machinery Directive 2006/42/EC
Harmonised standards applied, in particular:	EN ISO 12100 DIN EN 60335-1, DIN EN 61010 DIN EN 61000-6-2, DIN EN 61000-6-4
Date:	02.01.2013

You can find the EC Declaration of Conformity as a download under <http://www.prominent.de/Service/Download-Service.aspx>

21 Dimensional drawings

Dimensions sheet for Bello Zon® CDLb 6 (Dimensions in mm)
to 22 shown fully equipped

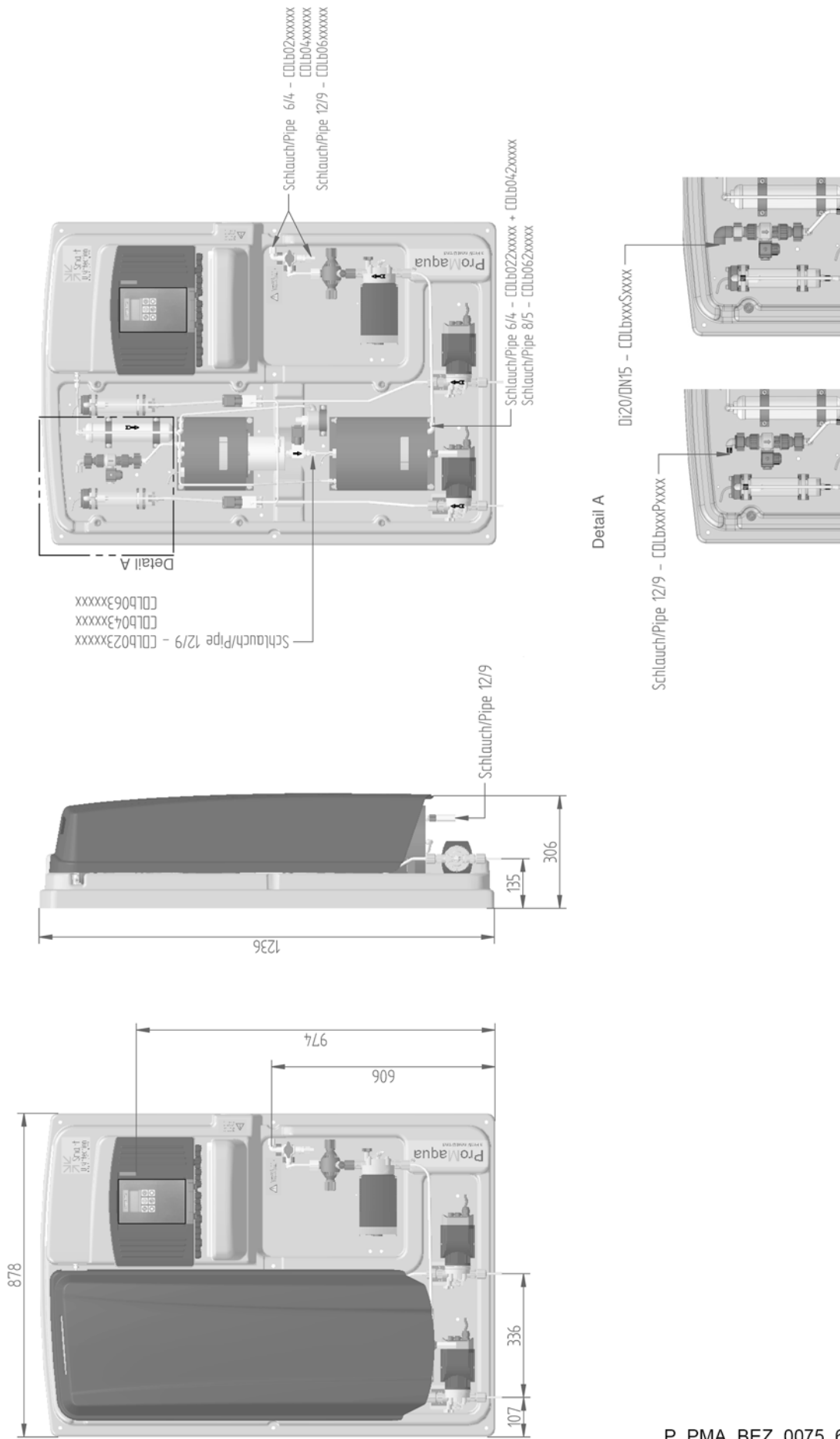

P_PMA_BEZ_0075_6

Drilling template for Bello Zon® CDLb 6 to 22 (Dimensions in mm)

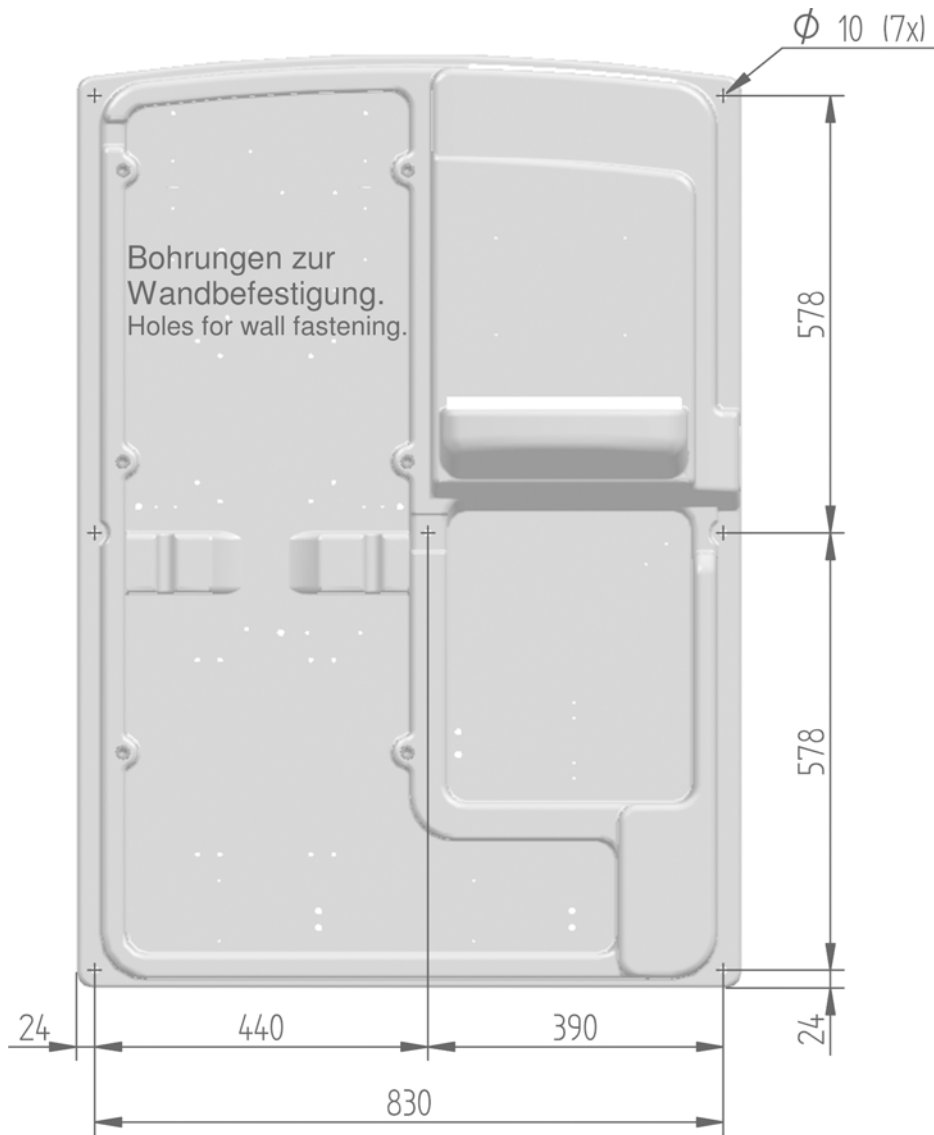

P_PMA_BEZ_0153

Dimensional drawings

Dimensions sheet Bello Zon® CDLb 55 in fully equipped version (Dimensions in mm)

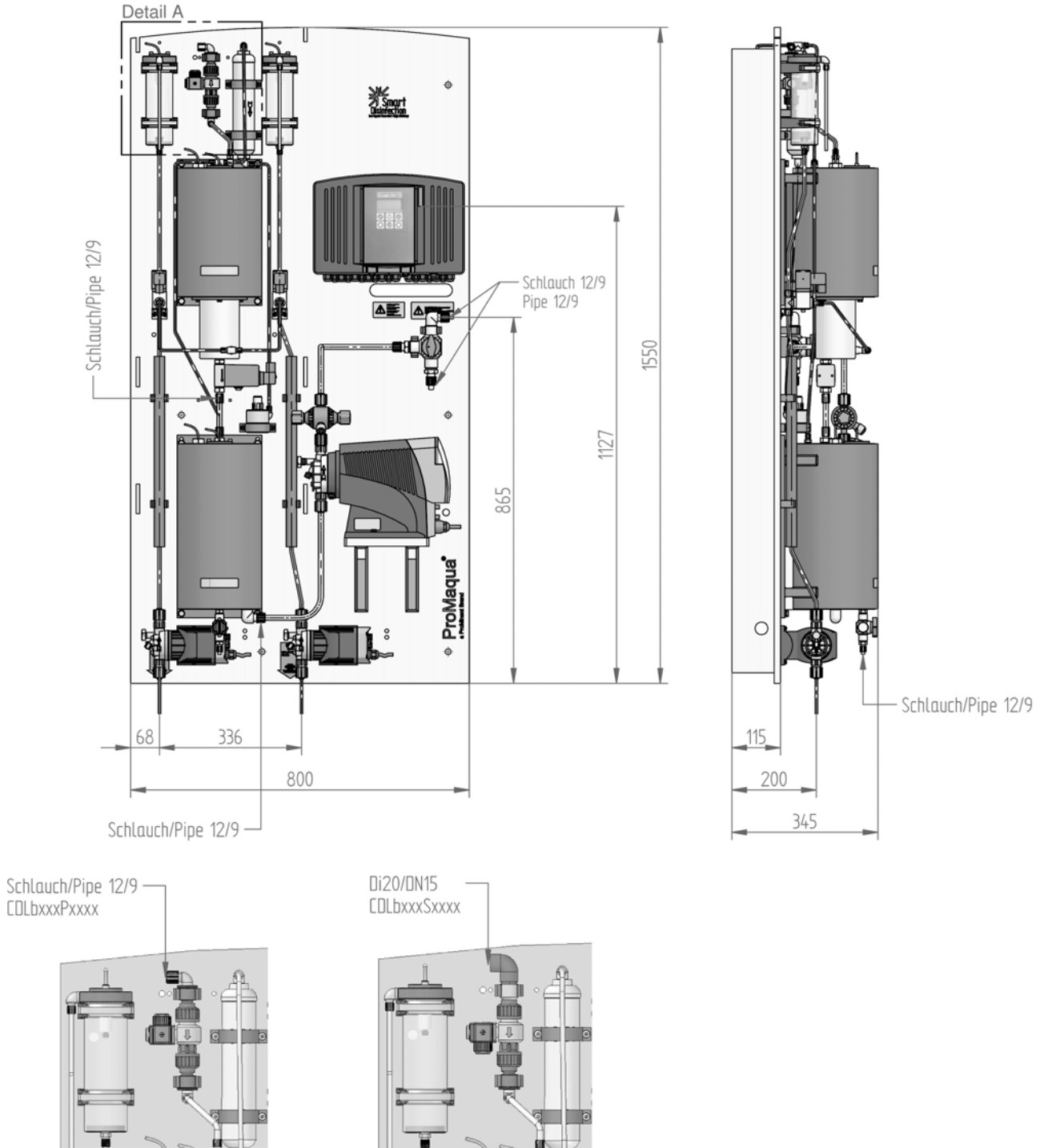

Detail A

P_PMA_BEZ_0155_SW_5

Drilling template for Bello Zon® CDLb 55 (Dimensions in mm)

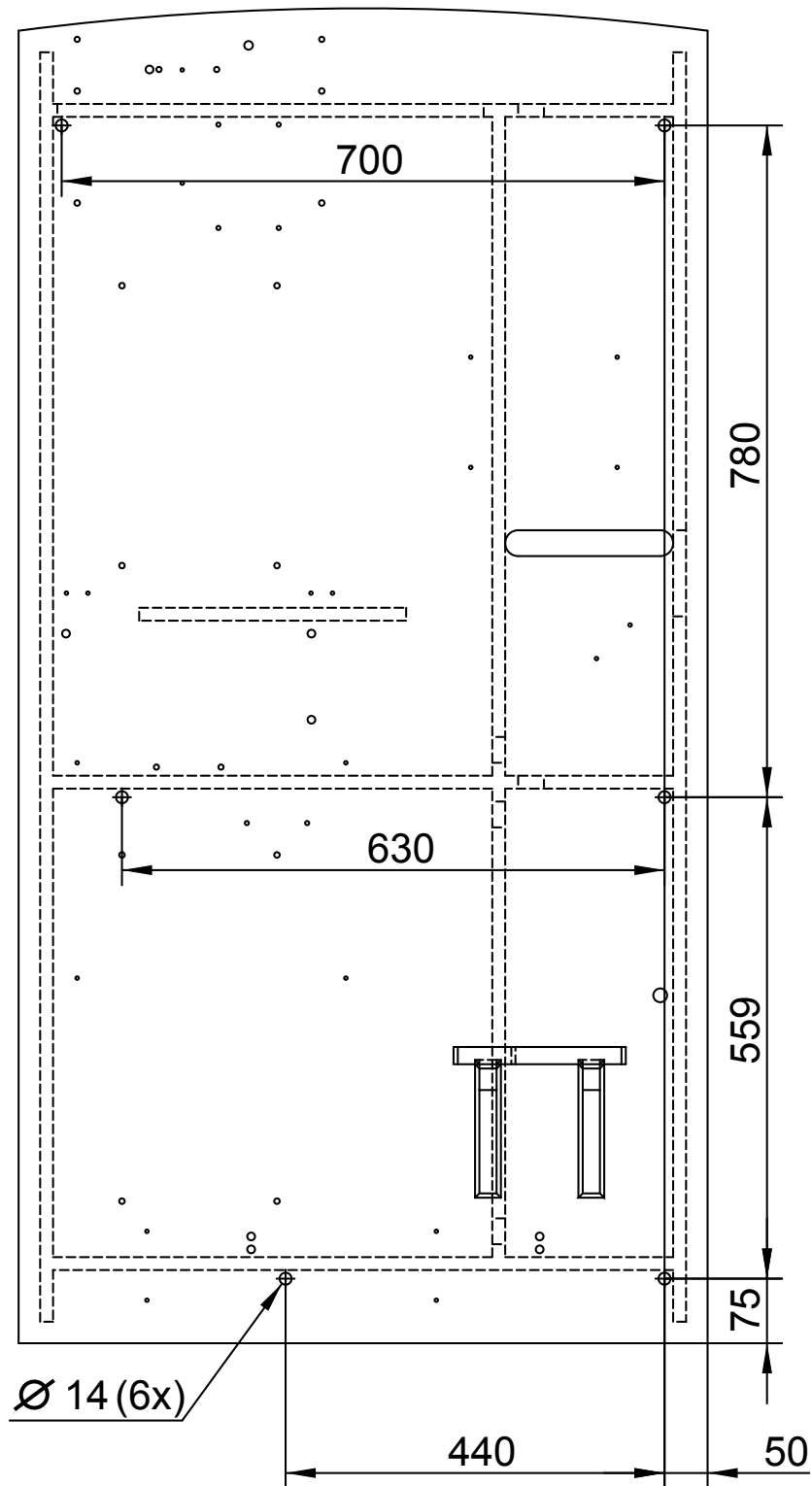

P_PMA_BEZ_0112_SW

22 Interface list

CDLb interface list with internal pre-storage vessel

CDLb		6 g/h	12 g/h	22 g/h	55 g/h
Water inlet:					
	ProMinent/Neutral:	12x9	12x9	12x9	12x9
	Switzerland:	Di20/DN15	Di20/DN15	Di20/DN15	Di20/DN15
ClO ₂ outlet:					
	with pump / MFV:	6x4	6x4	12x9	12x9
	with pump:	6x4	6x4	12x9	12x9
	without pump	6x4	6x4	8x5	12x9
Pre-storage tank outlet valve;					
	All	12x9	12x9	12x9	12x9
Supply voltage:					
	All	100...230 V, 50/60 Hz	100...230 V, 50/60 Hz	100...230 V, 50/60 Hz	100...230 V, 50/60 Hz
Fuse:					
	All	16 A	16 A	16 A	16 A

23 Wiring diagram CDLb

Wiring diagram Bello Zon® type CDLb with internal pre-storage vessel

CDLb 6-55 g/h

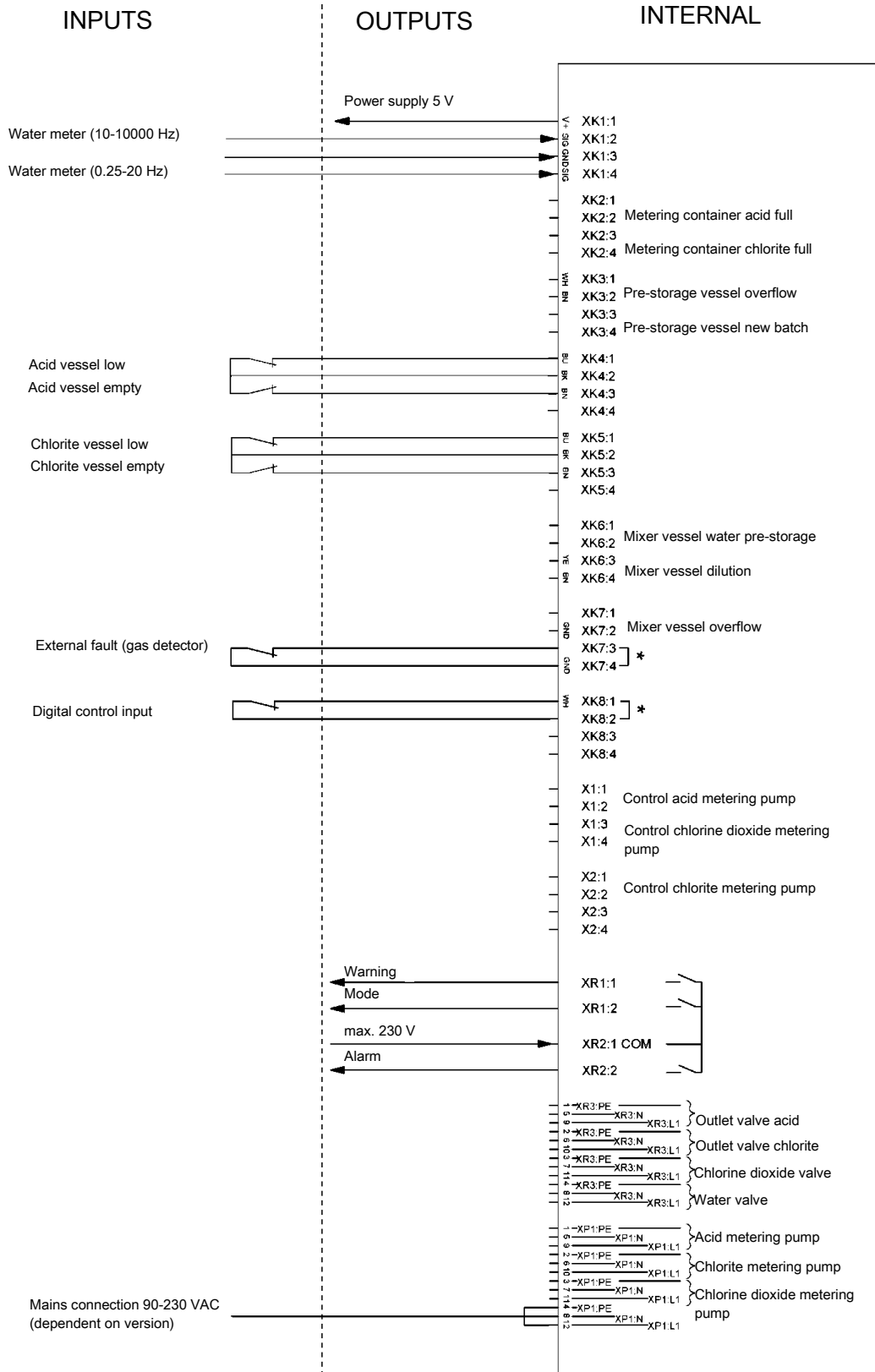

Terminal arrangement Bello Zon® type CDLb with internal pre-storage vessel

Contact (digital) inputs

Signal	Terminal identifier / Pin	LED identifier	Type of contact	Remarks
Water meter **	XK1/1,2,3,4	WM	-	1 = +5 V, 2 = Sign., 3 = GND, 4 = V+ Namur

** Only 1 water meter can be connected at any one time!

Control inputs

Signal	Terminal identifier / Pin	LED identifier	Type of contact	Remarks
Metering vessel acid full	XK2/1,2	MS	NC	XK2/2 = GND
Metering vessel chlorite full	XK2/3,4	MN	NC	XK2/4 = GND
Pre-storage vessel overflow	XK3/1,2	VUE	NC	XK3/2 = GND
Pre-storage vessel new batch	XK3/3,4	VM	N/O	XK3/4 = GND
Acid vessel low	XK4/1,2	SW	N/O	XK4/2 = GND
Acid vessel empty	XK4/2,3	SL	N/O	XK4/4 = GND
Chlorite vessel low	XK5/1,2	NW	N/O	XK5/2 = GND
Chlorite vessel empty	XK5/2,3	NL	N/O	XK5/4 = GND
Mixer vessel water pre-storage	XK6/1,2	MR	N/O	XK6/2 = GND
Mixer vessel diluting water	XK6/3,4	MV	NC	XK6/4 = GND
Mixer vessel overflow	XK7/1,2	MUE	NC	XK7/2 = GND
External fault (gas detector)	XK7/3,4	ES	NC	XK7/4 = GND; Jumpered as supplied

Signal	Terminal identifier / Pin	LED identifier	Type of contact	Remarks
Digital control input	XK8/1,2	PA	NC	Jumpered as supplied
+ / root				

Pulse outputs

Signal	Terminal identifier / Pin	LED identifier	Type of contact	Remarks
HCl metering pump	X1/1,2	PS	N/O	-
ClO ₂ metering pump	X1/3,4	PC	N/O	-
NaClO ₂ metering pump	X2/1,2	PN	N/O	-

Switching outputs

Signal	Terminal identifier / Pin	LED identifier	Type of contact	Remarks
Warning	XR1/1	WR	N/O	
Operation	XR1/2	BE	N/O	
Alarm	XR2/2	AL	NC	
shared root	XR2/1			

Voltage outputs

Signal	Terminal identifier / Pin	LED identifier	Type of contact	Remarks
Outlet valve acid	XR3/1,5,9	VA	N/O	PE: XP1. Fixed at 90/230V
Outlet valve chlorite	XR3/2,6,10	VA	N/O	PE: XP1. Fixed at 90/230V
Valve chlorine dioxide	XR3/3,7,11	VC	N/O	PE: XP1. Fixed at 90/230V
Water valve	XR3/4,8,12	VW	N/O	PE: XP1. Fixed at 90/230V
PE / N / L				

Voltage inputs

Signal	Terminal identifier / Pin	LED identifier	Remarks
HCl metering pump	XP1/1,5,9	-	
ClO ₂ metering pump	X13/2,6,10	-	
NaClO ₂ metering pump	XP1/3,7,11	-	
Mains terminal	XP1/4,8,12	-	
PE / N / L			

24 Decontamination declaration

ProMinent®

Declaration of Decontamination

(see download: www.prominent.com)

Because of legal regulations and for the safety of our employees and operation equipment, we need the „declaration of decontamination“, with your signature, before your order can be handled.

Please make absolutely sure to include it with the shipping documents, or – even better – attach it to the outside of the packaging.

Please return your products to:

Type of instrument / sensor: _____ **Serial number:** _____
Gerätetyp: Seriennummer:

Process data: Temperature: _____ [°C] Pressure: _____ [bar]
Prozessdaten: Temperatur: Druck:

Mediums and warnings:
Warnhinweise zum Medium:



	Medium/ Concentration <small>Medium/ Konzentration</small>	Identi- fication CAS No.	flammable <small>entzünd- lich</small>	toxic <small>giftig</small>	corrosive <small>ätzend</small>	harmful/ irritant <small>gesundheits- schädlich/reizend</small>	other* <small>sonstiges*</small>	harmless <small>unbedenklich</small>
Process medium <small>Medium im Prozess</small>								
Medium for process-cleaning <small>Medium zur Prozessreinigung</small>								
Returned part cleaned with <small>Medium zur Endreinigung</small>								

* explosive; oxidising; dangerous for the environment; biological risk; radioactive
 * explosiv; brandfördernd; umweltgefährlich; biogefährlich; radioaktiv

Please tick should one of the above be applicable, include security sheet and, if necessary, special handling instructions.

Reason for return:

Company data:

Company: _____ Phone number: _____
 Contact person: _____ Fax: _____
 Street: _____ E-Mail: _____
 Address: _____ Your order No: _____

“We hereby certify that the returned parts have been carefully cleaned. To the best of our knowledge they are free from any residues in dangerous quantities.”

 Place, date

 Company stamp and legally binding signature

25 Chlorine dioxide hazardous substance data sheet

(The text is based on the hazardous substances data sheet issued by the Bundesvereinigung der Firmen im Gas- und Wasserfach e.V. FIGWA, 50968 Cologne, dated 16.4.1998.)

Properties of chlorine dioxide and instructions for handling aqueous solutions

The chlorine dioxide solutions used for water treatment have a concentration of ≤ 2 g/L ClO_2 . At a temperature of up to 25 degrees C, this results in a chlorine dioxide concentration in the gas chamber of less than 100 g/m^3 . Consequently, if preparation is carried out correctly, this will rule out explosive decomposition in both the gas chamber and in the stock solution.

25.1 Physical and chemical properties

25.1.1 Chemical characterisation

Aqueous solution of chlorine dioxide (ClO_2) ≤ 2 g ClO_2 /L of physically dissolved chlorine dioxide gas

25.1.2 Properties of gaseous chlorine dioxide

Colour: Orange-yellow

Odour: Pungent

Melting point: -59 °C

Boiling point: 11 °C

Stability: Gaseous chlorine dioxide explosively decomposes at concentrations above 300 g/m^3 (≈ 10 % by volume) into chlorine and oxygen.

Dilution reduces the explosive tendency; there is no longer a risk of explosion at concentrations below 10 % by volume in gases with which chlorine dioxide does not react (e.g. with air, nitrogen, carbon dioxide).

A concentration of more than 8 g/L of chlorine dioxide (at a temperature of 20 degrees C) has to be reckoned with, for instance with a critical chlorine dioxide concentration in the gas chamber above an aqueous chlorine dioxide solution.

A severe to explosive-type reaction likewise occurs with oxidising substances.

25.1.3 Properties of an aqueous solution of chlorine dioxide

The gaseous phase is decisive.

Stability: Without an upper gas compartment, aqueous chlorine dioxide solutions are explosive from a concentration of around 30 g/L, i.e. they can autonomously explosively decompose without any external influences, such as heat, sparks, dirt or rust.

Chlorine dioxide is stable over several days as an aqueous dilute solution, provided the solution is pure and stored in the dark or if the temperature of the solution remains below 25 degrees C and its pH value is less than 7.

25.2 Handling aqueous chlorine dioxide solutions

25.2.1 Labelling and characters

Label the workplace and surrounding area using characters conforming to the (German) Accident Prevention Regulation "Chlorination of Water" (GUV 8.15, appendix 3).

25.2.2 Storage

Chlorine dioxide cannot be stored or transported either as a gas or as concentrated aqueous solution due to its explosive nature. Therefore it is only produced as dilute (see point 1.1.3) aqueous solutions in special systems for immediate use.

25.2.3 Measures in the event of spillage, escape, gas leaks

Precipitate the gas with water spray.

Pour sodium thiosulphate solution over escaped solution, then dilute with lots of water and wash away into the drain system.

25.2.4 Measures in the event of fires

Chlorine dioxide itself is not combustible, however it acts in an oxidising manner. Explosive decomposition at temperatures greater than 100 degrees C. Cool storage tanks with water, precipitate any escaped chlorine dioxide gas with a water spray. **There are no restrictions with regard to fire extinguishing agents in the event of fires in the vicinity.**

25.2.5 Disposal

See point 1.2.3

25.3 Health protection

25.3.1 MAC value and odour threshold

MAC value: 0.1 ppm (mL/m³) or 0.3 mg/m³

Odour threshold: The odour of chlorine dioxide gas is perceptible above a concentration of around 15 mg/m³ of air.

25.3.2 Personal protective equipment

Respiratory protection: Gas mask, filter B/grey

Eye protection: Safety goggles, face visor

Hand protection: Rubber gloves

Other: Protective clothing

25.3.3 Health hazards

A chlorine dioxide gas concentration of over 45 mg ClO₂/m³ causes breathing difficulties and leads to irritation of the mucous membranes and headaches.

In general, chlorine dioxide causes considerable irritation in the areas of the mucous membranes of the eyes and breathing organs. Depending on the concentration and the duration of the effect, the results can include a danger of suffocation, coughing fits, including vomiting, conjunctivitis and severe headaches, in severe cases pulmonary oedemas with breathlessness, oxygen starvation symptoms and circulatory failures. In the event of very brief influence of very high concentrations, there is a risk of laryngospasm or reflective apnoea or cardiac arrest. Harmful to the nervous system (e.g. eye muscle paralysis).

25.3.4 First Aid

First aid

If clothing comes into contact with chlorine dioxide or its aqueous solution, immediately remove the clothing and thoroughly wash the skin with soap and lots of water.

Rinse any splashes into the eyes for several minutes under running water, keeping the eyes opened.

If chlorine dioxide is inhaled, keep the patient in fresh air, keep absolutely still, lie horizontally, keep warm.

Inform a doctor immediately, even if discomfort does not become immediately apparent. If necessary, transport quickly to a hospital using quick, but gentle transport.

25.4 More Information

DVGW Data Sheet W 624 " Chlorine dioxide metering systems", Edition 02/2012.

DVGW Worksheet W 224 "Chlorine dioxide in water treatment"

Accident prevention regulation "Chlorination of water" (GUV 8.15)

Ullmann Volume 5, Page 551

Kühn-Birett, Sheet C 20

Note:

The information is based on our state of knowledge at the time of these operating instructions going to print. It is intended to contribute to the safe handling of aqueous chlorine dioxide solution and, as such, does not have the purpose of ensuring certain properties. Automatic correction upon revision is not guaranteed, also legally non-binding.

This data should only be regarded as an initial starting point for operators. The operator should also himself obtain the latest information, especially safety information about chlorine dioxide solutions.

26 Index

A			
Accessories.....	60	Intended use.....	8
Allocating the digital input.....	39	Interface list.....	68
Ambient conditions.....	13	K	
Applied harmonised standards.....	62	Key functions.....	32
Assembly.....	18	M	
B		Multifunctional valve.....	61
Basic rules.....	7	N	
C		Notes for the System Operator.....	2
Carrying out commissioning.....	41	O	
Changing the user code.....	37	Operating indicator.....	53
Chemicals.....	60	Operating menu, overview.....	35
Chlorine dioxide hazardous substance data sheet.....	73	Operating menu, schematic.....	33
CIO ₂ metering.....	38	P	
Collecting pan.....	60	Paging through the protocol.....	49
Configuring alarm relay contact types.....	40	Performance data.....	57
Configuring alarm relays.....	40	Perform service.....	50
Control.....	27	Personal protective equipment.....	9
Control, definition.....	15	Point of injection.....	60
Control elements.....	32	Preparing the mains connection.....	30
Controlling the system.....	32	Pre-storage module.....	60
D		Properties of an aqueous solution of chlorine dioxide...	73
Decommissioning.....	55	Protective equipment.....	9
Decontamination declaration.....	72	Q	
Definitions.....	15	Qualification of personnel.....	8
Designation of the product.....	62	R	
Disposal.....	56	Relevant EC directives.....	62
E		Requirements for the installation site.....	16
Emergency stop switch.....	30	S	
External storage module.....	60	Safety chapter.....	7
F		Scope of supply.....	13
Fault alerts.....	53	Serial number.....	62
Flush system.....	47	Setting the language.....	36
Functional description.....	15	Shipping weight.....	57
H		Sound pressure level.....	12
Handling aqueous chlorine dioxide solutions.....	74	Storage and transport.....	13
Health protection.....	74	Supplementary information.....	2
I		System, definition.....	15
Identification of safety notes.....	7	T	
Information.....	2	Technical data.....	57
Information in the event of an emergency.....	12	Terminals.....	29
Installation, electrical.....	27	Transport.....	13
Installation site.....	16	Troubleshooting.....	53
Instructions.....	2	W	
Instructions for entering.....	11	Warning messages.....	53
Instrumentation.....	60	Warning sign.....	7
		Weight.....	57



ProMinent GmbH
Im Schuhmachergewann 5-11
D-69123 Heidelberg
Telephone: +49 6221 842-0
Fax: +49 6221 842-612
email: info@prominent.com
Internet: www.prominent.com

985385, 4, en_GB