

HEIGHT ADJUSTABLE DESK

2019 Catalog V2

Loctek[®]
— ERGONOMIC —

Zhejiang Loctek Intelligent Motion Technology Co. LTD

Contact us

Tel: +86-574-88070236
Fax: +86-574-88098788
Email: sales@loctek.com

Visit us

Floor 17.18.19, Jindong Building, No.
536, Xueshi Road, Shouan Street,
Yinzhou District, Ningbo, China

Our Factory

No. 9, GaoYa Road, Science and
Technology Park, Jiangshan Town,
Yinzhou District, Ningbo, China



Loctek Overview

Company Overview

Loctek is a public enterprise in China, as a top manufacturer of linear actuation solutions. Our product comprises intelligent actuator systems for offices, kitchens, and garages, etc.

With the value of building a healthy, comfortable and innovative interior environment, Loctek focuses on enhancing R&D level, insists on lean production, improves the user experience while providing an entire scheme.

At present, Loctek has a sophisticated system to guarantee quality, production, transportation, and patent protection.

Global Factory

Loctek owns three major manufacturing bases, in Ningbo Binhai, Ningbo Jiangshan, and Ho Chi Minh City in Vietnam, with a total production area of 113,000 square meters.



Advanced Equipment

With too many human factors, the traditional mode of production affects the stability of product quality. Loctek automatic production lines avoid manual intervention providing more stable and reliable quality.



R&D Strength

R&D Team

Loctek obtains over 300 patents including 17 patents for invention. Technology & patent barrier has been built in Loctek with 50% of products are under protection. As a technical innovation-oriented company, the scale of our R&D team is over 200 engineers whose annual outcomes are more than 100 new arrivals.



Ningbo University
Spinal Stress Test

Certification & Patent

Never put customers in risk of patent issue. Our patent team studies and researches competitors' products to ensure our products are unique and different.

124	104	317	169	37	21	20

Loctek UL & GS listed models checking website
<http://database.ul.com>
<http://www.tuvdotcom.com>

UL WDTP & TUV WDTP Witness Lab



Adults spend up to **60%** of their day sitting down



TABLE OF CONTENTS

11	25	27
Height Adjustable Desk Frame (Holeless Design)	Quick Installation Height Adjustable Desk	Height Adjustable Desk Frame (Standard Design)
43	46	48
Lifting Column	Height Adjustable Conference Desk	Height Adjustable Mobile Desk
50	51	56
Height Adjustable Gaming Desk	Accessory	Index

Note: All images and specifications are for reference only. Actual product may vary.

Product Application

Re-planning a workplace with height adjustable desks helps the organization and employees in many ways, from managing the cost of healthcare and missed time, to improvements in productivity and work output. The benefits of ergonomic height adjustable desks in the work environment have spread rapidly, and as a seller of ergonomic solution products and accessories, there's no better time to meet this demand!



Plan Your Workspace with Loctek

**Team
Workspaces**

**Café/Break
Area**

**Supervisor
Station**





Height Adjustable Desk Collection



2-LEG
Rectilinear Worksurface



3-LEG
90° Worksurface



3-LEG
120° Worksurface



2-Desk Solution
Rectilinear Worksurface



3-Desk Solution
120° Worksurface



4-Desk Solution
Rectilinear Worksurface

Product Highlights

Smooth Height Adjustment

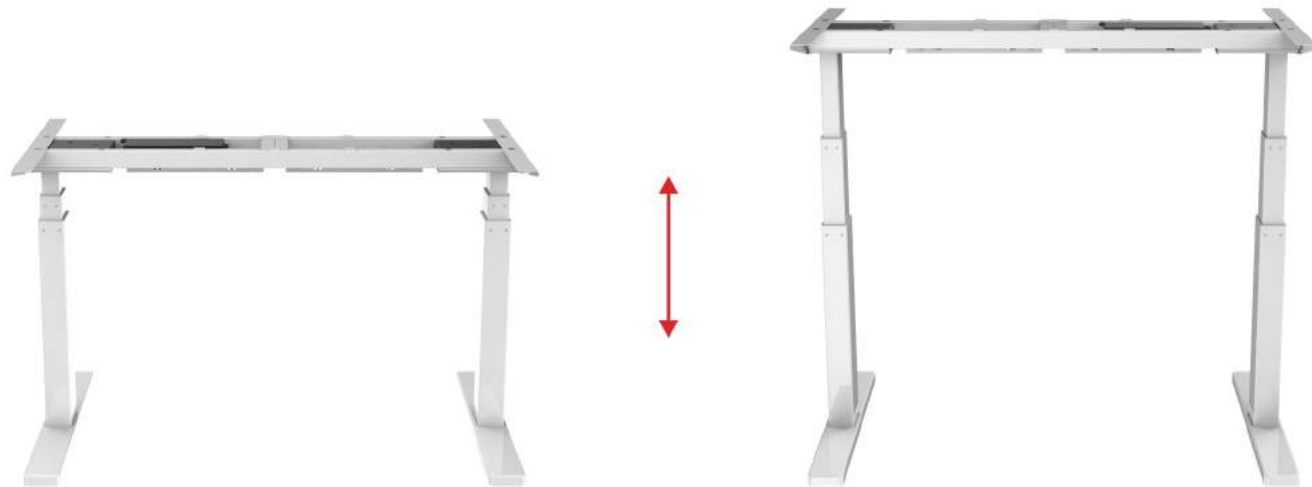

Anti-Collision System



During height adjustment, when tabletop comes in contact with another object, it instantly stops and reverses to avoid damage.

Alternative Width Adjustment

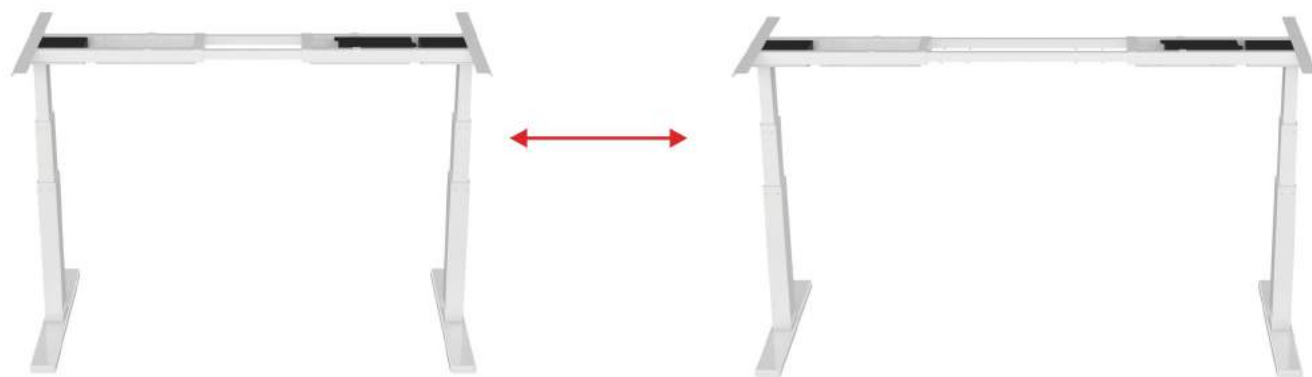









Whisper-Quiet Design



Ultra-silent operation lower than 50dB. Loctek will bring more comfort not noise in your work environment.

Desk Frame Options

Tabletop

 <p>Rectilinear 2-Leg</p>	 <p>Curved Edge 2-Leg</p>	 <p>120° 2-Leg Equal Returns</p>	 <p>90° 2-Leg Equal Returns</p>
<p>Shape</p> <p>1524x762mm/60.0"x30.0" 1400x700mm/55.1"x27.6" 1219x762mm/48.0"x30.0" 1200x600mm/47.2"x23.6"</p>	<p>1524x762mm/60.0"x30.0" 1219x762mm/48.0"x30.0"</p>	<p>900x610mm/35.4"x24.0"</p>	<p>1219x600mm/48.0"x23.6"</p>
 <p>Long Right Return</p>	 <p>Long Left Return</p>	 <p>Long Right Return</p>	 <p>Long Left Return</p>
<p>Shape</p> <p>1600x1100mm/63.0"x43.3"</p>	<p>Option A: 1524x762mm/60.0"x30.0" 1219x762mm/48.0"x30.0"</p>	<p>Option B: 1828x762mm/72.0"x30.0" 1219x762mm/48.0"x30.0"</p>	

Tabletop Color



Frame Color



Feet Version



Add On



Bluetooth Dongle



Users can remotely control Loctek height adjustable desk via our APP with Bluetooth Dongle.

Desk Frame Options

Control Panel



For ET114E
Two button remote.
Up/down switch.



HS02A-1
Two button remote.
Up/down switch.



HS03A-1
Two button remote.
Up/down switch.



HS13A-1
4 programmable positions.
Up/down switch.
Safety screen lock.



HS13B-1
4 programmable positions.
Up/down switch.
Safety screen lock.
USB charging



HS04A-1
Two button remote.
Up/down switch.
Digital height display.



HS05A-1
3 programmable positions.
Up/down switch.
Digital height display.



HS01B-1
Conventional control pad.
3 programmable positions.
Up/down switch.
Digital height display.
Time reminder.



HS11A-1
3 programmable positions.
Up/down switch.
Digital height display.
Time reminder.



HS11B-1
3 programmable positions.
Up/down switch.
Digital height display.
Time reminder.
USB charging

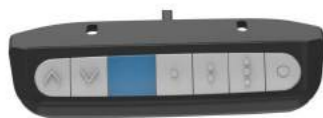

HS06A-1
Braille button.
3 programmable positions.
Up/down switch.
Digital height display.

Difficult Maintenance



Before:

All things on the table must be removed for changing the parts.



35 min.

A lack of maintainability will be evident as high product maintenance costs, long out-of-service times, and possible.

Making Future Maintenance Easier



represent models featured "Ease of Maintenance"

After:

All things on the table stay in place, fast and convenient.



5 min.

Loctek frames incorporated a feature to allow quick maintenance without needing tools or having to lift, which makes many maintenance tasks would not be particularly difficult to do.

Our new design for maintainability is made for time-saving and cost-saving.

Take control of the wild cables

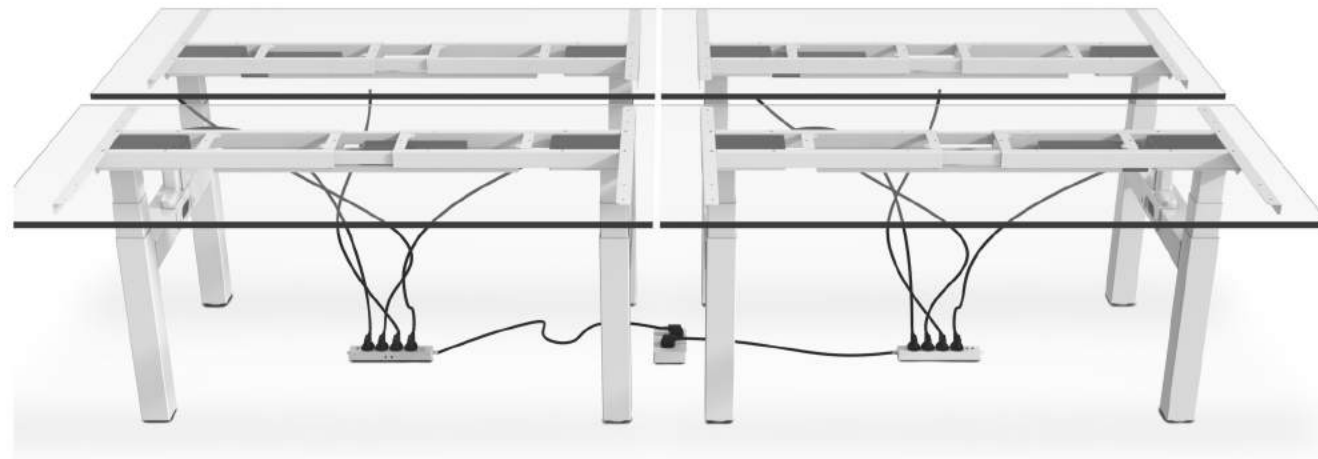

as well as your work environment

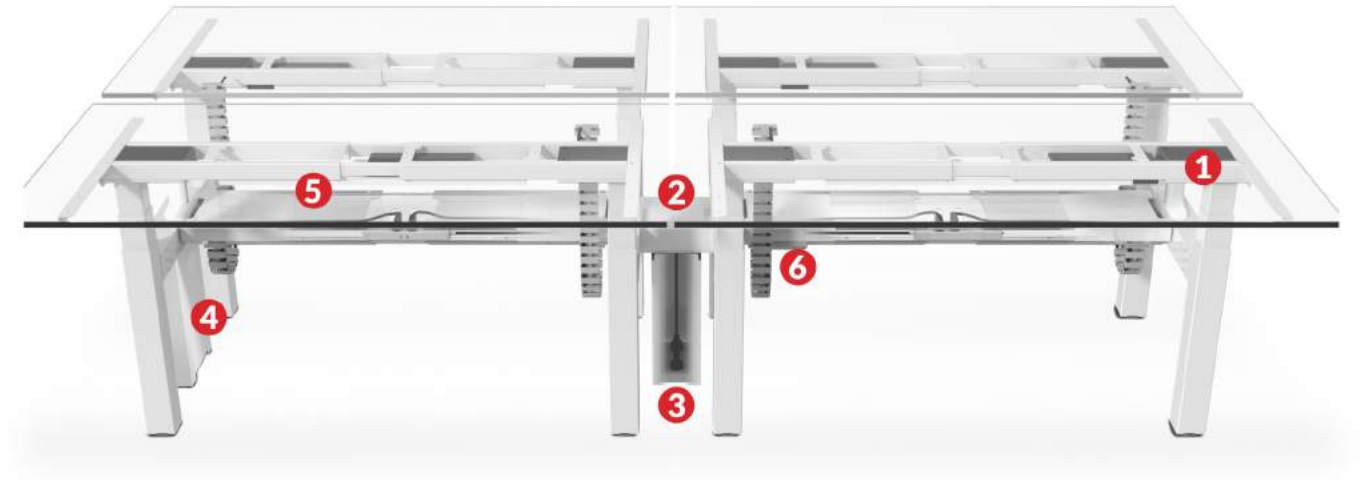

Single Desk Cable Management



CMP021-01
Integrated Cable Riser
Color: ●○○



CMP017
Independent Cable Spine
Color: ●○○

Multi-Desk Cable Management



① CMP022-01
Privacy Panel Adapter
Color: ●○○



② CMP022-02
Cable Management Component
Color: ●○○



③ CMP022-03
Cable Management Component
Color: ●○○



④ CMP022-04
Vertical Cable Tray
Color: ●○○



⑤ CMP022-05
Central Cable Tray
Color: ●○○



⑥ CMP022-06
Cable Riser
Color: ●○○

Holeless Frame

| Dual-Motor | 3-Stage | Square Column

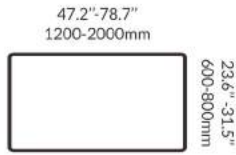

ET223

Height Range: 22.8"-48.4"/580-1230mm

Stroke: 25.6"/650mm

Speed: 38mm/s

Load Capacity: 275lbs/125kg

Power: 100V-240V

Sound Level: <50dB



| Dual-Motor | 3-Stage | Triangle Feet

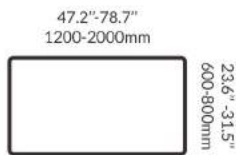

ET223-FT

Height Range: 23.2"-48.8"/590-1240mm

Stroke: 25.6"/650mm

Speed: 38mm/s

Load Capacity: 275lbs/125kg

Power: 100V-240V

Sound Level: <50dB



| Dual-Motor | 3-Stage | C-Leg

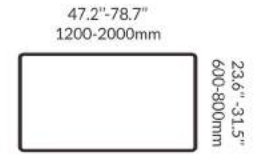

ET223-BZ

Height Range: 23.6"-49.2"/600-1250mm

Stroke: 25.6"/650mm

Speed: 38mm/s

Load Capacity: 275lbs/125kg

Power: 100V-240V

Sound Level: <50dB



Easily slide the cabinet over the desk foot to maximize leg room for users.

Holeless Frame

| Dual-Motor | 3-Stage | Dual Benching

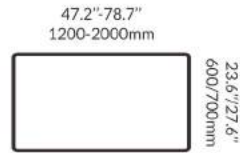

NEW

ET223H

Height Range: 22.8"-48.4"/580-1230mm

Stroke: 25.6"/650mm

Speed: 38mm/s

Load Capacity: 275lbs/125kg

Power: 100V-240V

Sound Level: <50dB



| Dual-Motor | Dual Benching | C-Leg

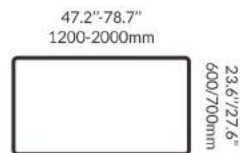

NEW

ET223H-BZ

Height Range: 23.6"-49.2"/600-1250mm

Stroke: 25.6"/650mm

Speed: 38mm/s

Load Capacity: 275lbs/125kg

Power: 100V-240V

Sound Level: <50dB



| Triple-Motor | 3-Stage | 90° L-Shaped

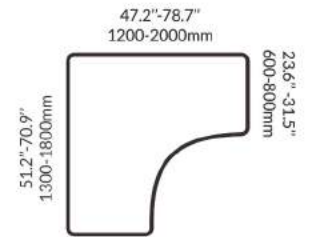

NEW

ET223L

Height Range: 22.8"-48.4"/580-1230mm

Stroke: 25.6"/650mm

Speed: 38mm/s

Load Capacity: 330lbs/150kg

Power: 100-127V/200-240V

Sound Level: <50dB



| Triple-Motor | 90° L-Shaped | C-Leg

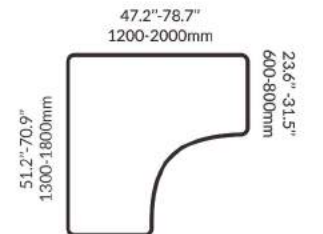

NEW

ET223L-BZ

Height Range: 23.6"-49.2"/600-1250mm

Stroke: 25.6"/650mm

Speed: 38mm/s

Load Capacity: 330lbs/150kg

Power: 100-127V/200-240V

Sound Level: <50dB



Holeless Frame

| Triple-Motor | 3-Stage | 120° Corner Use

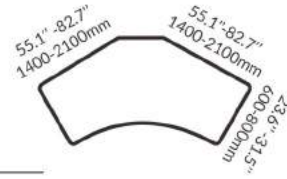

NEW

ET223V

Height Range: 22.8"-48.4"/580-1230mm

Stroke: 25.6"/650mm

Speed: 38mm/s

Load Capacity: 330lbs/150kg

Power: 100-127V/200-240V

Sound Level: <50dB



| Triple-Motor | 120° Corner Use | C-Leg

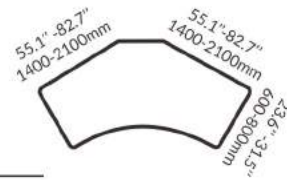

NEW

ET223V-BZ

Height Range: 23.6"-49.2"/600-1250mm

Stroke: 25.6"/650mm

Speed: 38mm/s

Load Capacity: 330lbs/150kg

Power: 100-127V/200-240V

Sound Level: <50dB



| Multi-Motor | 3-Stage | 3-Desk Solution

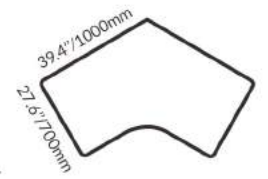

NEW

ET223Y

Height Range: 22.8"-48.4"/580-1230mm

Stroke: 25.6"/650mm

Speed: 38mm/s

Load Capacity: 220lbs/100kg

Power: 100V-240V

Sound Level: <50dB



| Multi-Motor | 3-Stage | 3-Desk Solution

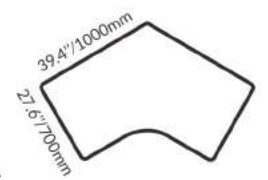

NEW

ET223Y-BZ

Height Range: 23.6"-49.2"/600-1250mm

Stroke: 25.6"/650mm

Speed: 38mm/s

Load Capacity: 220lbs/100kg

Power: 100V-240V

Sound Level: <50dB



Holeless Frame

| Dual-Motor | Enhanced Column | Rectangular Column

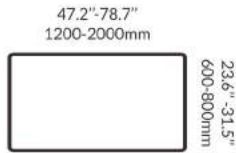

ET221

Height Range: 22.8"-48.4"/580-1230mm

Stroke: 25.6"/650mm

Speed: 38mm/s

Load Capacity: 275lbs/125kg

Power: 100V-240V

Sound Level: <50dB



| Dual-Motor | 3-Stage | Enhanced Column

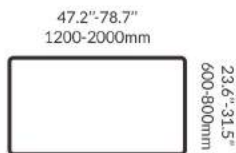

ET222

Height Range: 23.6"-49.2"/600-1250mm

Stroke: 25.6"/650mm

Speed: 38mm/s

Load Capacity: 275lbs/125kg

Power: 100V-240V

Sound Level: <50dB



| Dual-Motor | 3-Stage | Reversed Column

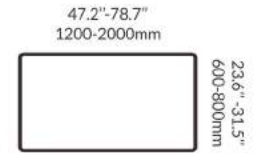

ET225

Height Range: 23.6"-49.2"/600-1250mm

Stroke: 25.6"/650mm

Speed: 38mm/s

Load Capacity: 275lbs/125kg

Power: 100V-240V

Sound Level: <50dB



| Dual-Motor | 3-Stage | Enhanced Column

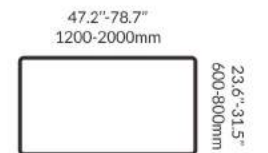

ET227

Height Range: 23.6"-49.2"/600-1250mm

Stroke: 25.6"/650mm

Speed: 38mm/s

Load Capacity: 275lbs/125kg

Power: 100V-240V

Sound Level: <50dB



Holeless Frame

83.1"-149.6"
2110-3800mm

23.6"-47.2"
600-1200mm

| Multi-Motor | 3-Stage | Meeting Desk



ET223I

Height Range: 22.8"-48.4"/580-1230mm

Stroke: 25.6"/650mm

Speed: 38mm/s

Load Capacity: 330lbs/150kg

Power: 100-127V/200-240V

Sound Level: <50dB



Holeless Frame

| Dual-Motor | 2-Stage | Enhanced Column

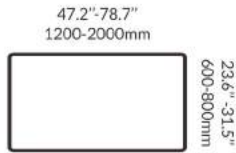

ET121

Height Range: 27.2"-46.5"/690-1180mm

Stroke: 19.3"/490mm

Speed: 32mm/s

Load Capacity: 220lbs/100kg

Power: 100V-240V

Sound Level: <50dB



| Dual-Motor | 2-Stage | Enhanced Column

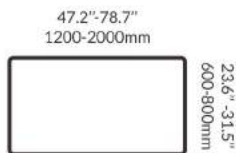

ET122

Height Range: 27.9"-47.2"/710-1200mm

Stroke: 19.3"/490mm

Speed: 32mm/s

Load Capacity: 220lbs/100kg

Power: 100V-240V

Sound Level: <50dB



| Dual-Motor | 2-Stage | Enhanced Column

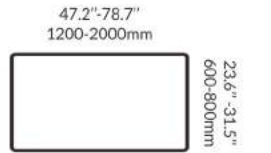

ET123

Height Range: 27.2"-46.5"/690-1180mm

Stroke: 19.3"/490mm

Speed: 32mm/s

Load Capacity: 220lbs/100kg

Power: 100V-240V

Sound Level: <50dB



| Dual-Motor | 2-Stage | Reversed Column

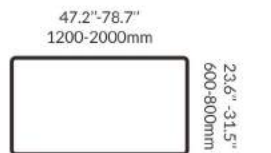

ET124

Height Range: 27.9"-47.2"/710-1200mm

Stroke: 19.3"/490mm

Speed: 32mm/s

Load Capacity: 220lbs/100kg

Power: 100V-240V

Sound Level: <50dB



Holeless Frame

| Dual-Motor | 2-Stage | Reversed Column

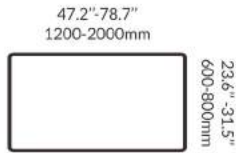

ET125

Height Range: 27.9"-47.2"/ 710-1200mm

Stroke: 19.3"/490mm

Speed: 32mm/s

Load Capacity: 220lbs/100kg

Power: 100V-240V

Sound Level: <50dB



| Dual-Motor | 2-Stage | Reversed Column

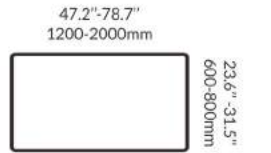

ET126

Height Range: 27.9"-47.2"/ 710-1200mm

Stroke: 19.3"/490mm

Speed: 32mm/s

Load Capacity: 220lbs/100kg

Power: 100V-240V

Sound Level: <50dB



| Dual-Motor | 2-Stage | Enhanced Column

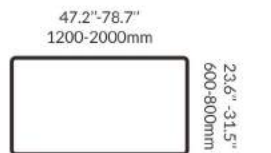

ET127

Height Range: 27.9"-47.2"/ 710-1200mm

Stroke: 19.3"/490mm

Speed: 32mm/s

Load Capacity: 220lbs/100kg

Power: 100V-240V

Sound Level: <50dB



Quick Installation Desk

| 3-Stage | Square Column | Pre-Assembled

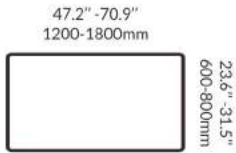

ET203(KZ01)

Height Range: 23.6"-48.4"/600-1230mm

Stroke: 24.8"/630mm

Speed: 38mm/s

Load Capacity: 275lbs/125kg

Power: 100V-240V

Sound Level: <50dB

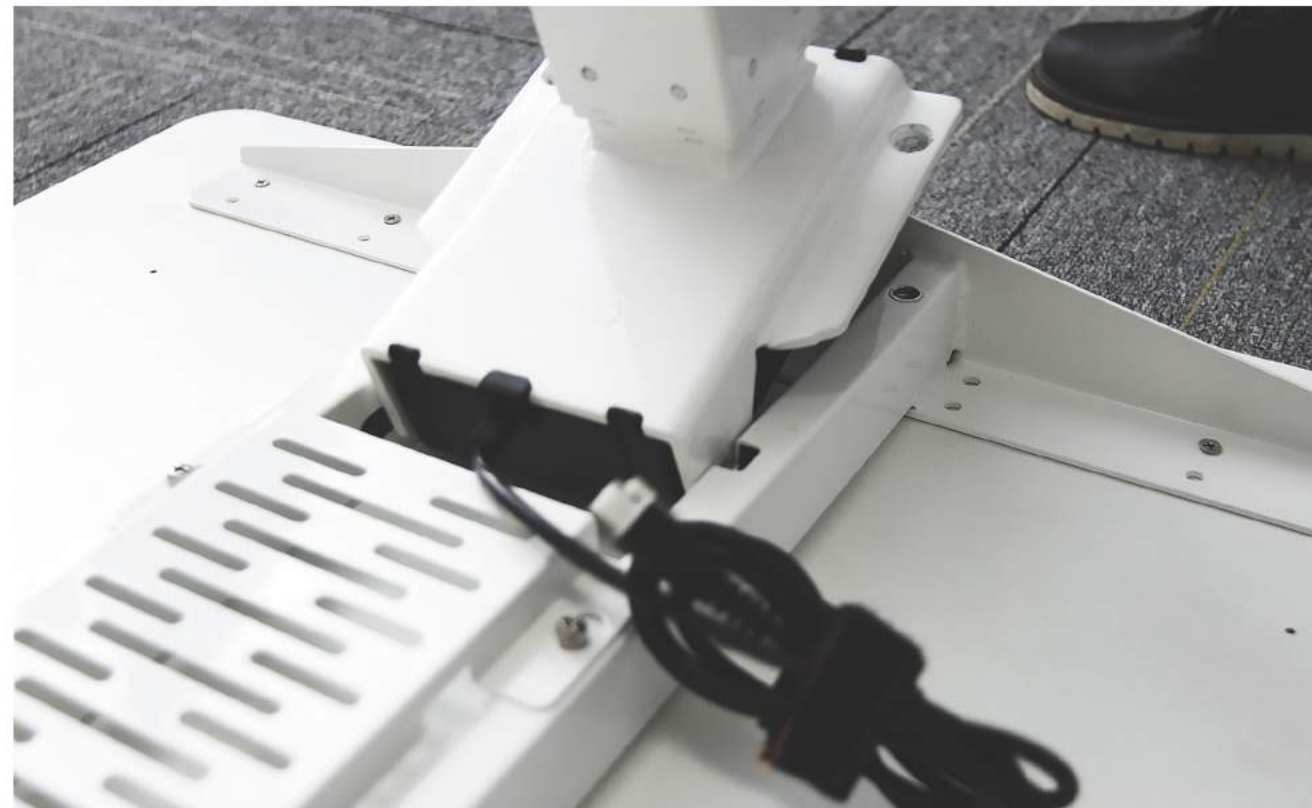

| 2-Stage | Rectangular Column | Pre-Assembled

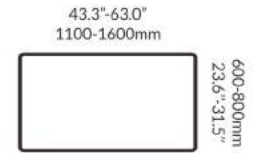

ET114(KZ01)

Height Range: 28.0"-47.6"/710-1210mm

Stroke: 19.7"/500mm

Speed: 25mm/s

Load Capacity: 154lbs/70kg

Power: 100V-240V

Sound Level: <50dB



| 3-Stage | Square Column | Foldable Column

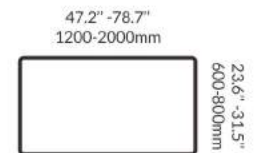

ET203(ZD01)

Height Range: 23.6"-49.2"/600-1250mm

Stroke: 25.6"/650mm

Speed: 38mm/s

Load Capacity: 275lbs/125kg

Power: 100V-240V

Sound Level: <50dB



Single Motor

| 2-Stage | Reversed Column | Rectangular Column

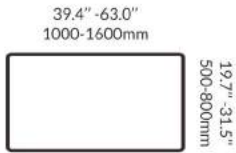

ET114-N

Height Range: 28.0"-47.6"/710-1210mm
Stroke: 19.7"/500mm
Speed: 25mm/s
Load Capacity: 154lbs/70kg
Power: 100V-240V
Sound Level: <50dB



| 2-Stage | Reversed Column | Economical Model

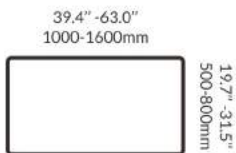

ET114E-N

Height Range: 28.0"-47.6"/710-1210mm
Stroke: 19.7"/500mm
Speed: 25mm/s
Load Capacity: 154lbs/70kg
Power: 100V-240V
Sound Level: <50dB



| 2-Stage | Enhanced Column | Rectangular Column

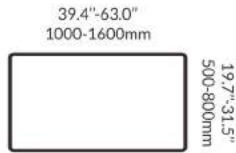

ET112-N

Height Range: 28.0"-47.6"/710-1210mm
Stroke: 19.7"/500mm
Speed: 25mm/s
Load Capacity: 154lbs/70kg
Power: 100V-240V
Sound Level: <50dB



| 2-Stage | Enhanced Column | Dual Benching

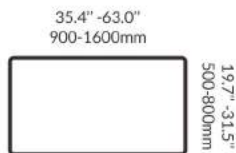

ET112H-N

Height Range: 27.2" -46.9"/690-1190mm
Stroke: 19.7"/500mm
Speed: 25mm/s
Load Capacity: 154lbs/70kg
Power: 100V-240V
Sound Level: <50dB



Dual-Motor

| 2-Stage | Reversed Column | Extended Side Bracket

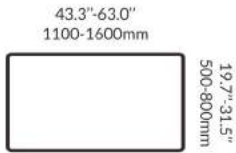

ET102B

Height Range: 28.0"-45.7"/710-1160mm
 Stroke: 17.7"/450mm
 Speed: 32mm/s
 Load Capacity: 220lbs/100kg
 Power: 100V-240V
 Sound Level: <50dB



| 2-Stage | Reversed Column | Rectangular Column

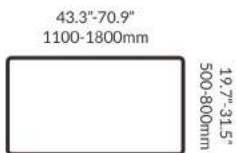

ET102D

Height Range: 28.0"-46.9"/710-1190mm
 Stroke: 18.9"/480mm
 Speed: 32mm/s
 Load Capacity: 220lbs/100kg
 Power: 100V-240V
 Sound Level: <50dB



| 3-Stage | Enhanced Column | Rectangular Column

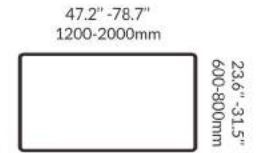

ET201

Height Range: 23.6"-48.4"/600-1230mm
 Stroke: 24.8"/630mm
 Speed: 38mm/s
 Load Capacity: 275lbs/125kg
 Power: 100V-240V
 Sound Level: <50dB



| 3-Stage | Enhanced Column | Rectangular Column

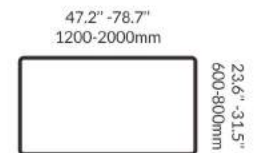

ET202

Height Range: 23.6"-48.4"/600-1230mm
 Stroke: 24.8"/630mm
 Speed: 38mm/s
 Load Capacity: 275lbs/125kg
 Power: 100V-240V
 Sound Level: <50dB



Dual-Motor

| 3-Stage | Enhanced Column | Square Column

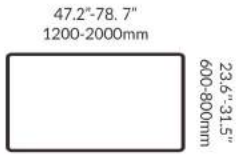

ET203

Height Range: 23.6"-48.4"/600-1230mm

Stroke: 24.8"/630mm

Speed: 38mm/s

Load Capacity: 275lbs/125kg

Power: 100V-240V

Sound Level: <50dB



| 3-Stage | Reversed Column | Rectangular Column

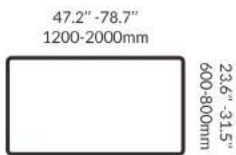

ET204

Height Range: 24.4"-49.2"/620-1250mm

Stroke: 24.8"/630mm

Speed: 38mm/s

Load Capacity: 275lbs/125kg

Power: 100V-240V

Sound Level: <50dB



| 3-Stage | Reversed Column | Square Column

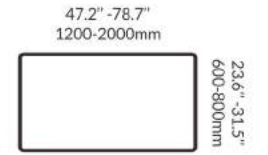

ET205

Height Range: 24.4"-49.2"/620-1250mm

Stroke: 24.8"/630mm

Speed: 38mm/s

Load Capacity: 275lbs/125kg

Power: 100V-240V

Sound Level: <50dB



| 3-Stage | Enhanced Column | Round Column

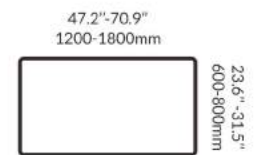

ET207

Height Range: 24.4"-49.2"/620-1250mm

Stroke: 24.8"/630mm

Speed: 38mm/s

Load Capacity: 275lbs/125kg

Power: 100V-240V

Sound Level: <50dB



Dual-Motor



| 3-Stage | Square Column | L-Shaped

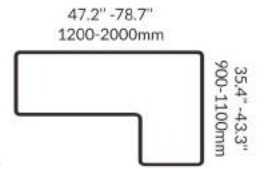

ET203DL



Height Range: 23.6"-48.4"/600-1230mm

Stroke: 24.8"/630mm

Speed: 38mm/s

Load Capacity: 275lbs/125kg

Power: 100V-240V

Sound Level: <50dB



| 3-Stage | Rectangular Column | L-Shaped

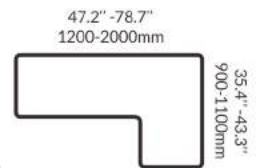

ET201DL



Height Range: 23.6"-48.4"/600-1230mm

Stroke: 24.8"/630mm

Speed: 38mm/s

Load Capacity: 275lbs/125kg

Power: 100V-240V

Sound Level: <50dB



Dual-Motor

| Dual-Motor | 2-Stage | Holeless Frame

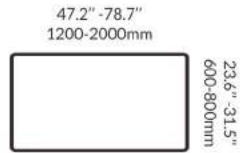

ET122H

Height Range: 27.2"-46.5"/690-1180mm

Stroke: 19.3"/490mm

Speed: 32mm/s

Load Capacity: 220lbs/100kg

Power: 100V-240V

Sound Level: <50dB



| 3-Stage | Rectangular Column | Dual Benching

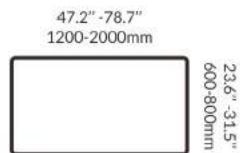

ET201H

Height Range: 23.6"-48.4"/600-1230mm

Stroke: 24.8"/630mm

Speed: 38mm/s

Load Capacity: 275lbs/125kg

Power: 100V-240V

Sound Level: <50dB



| 3-Stage | Square Column | Dual Benching

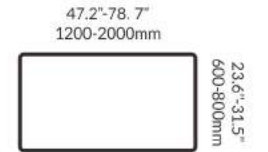

ET203H

Height Range: 23.6"-48.4"/600-1230mm

Stroke: 24.8"/630mm

Speed: 38mm/s

Load Capacity: 275lbs/125kg

Power: 100V-240V

Sound Level: <50dB





Height Adjustable Desk

Multi-Motor

| 3-Stage | Square Column | 90° L-Shaped

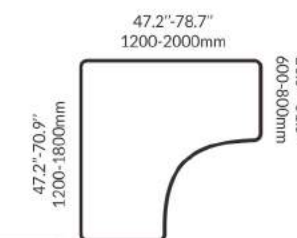

ET203L

Height Range: 23.6"-48.4"/600-1230mm

Stroke: 24.8"/630mm

Speed: 38mm/s

Load Capacity: 330lbs/150kg

Power: 100-127V/200-240V

Sound Level: <50dB



| 3-Stage | Square Column | 120° Corner Use

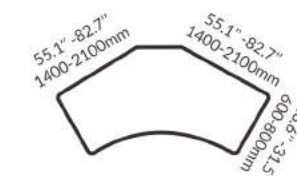

ET203V

Height Range: 23.6"-48.4"/600-1230mm

Stroke: 24.8"/630mm

Speed: 38mm/s

Load Capacity: 330lbs/150kg

Power: 100-127V/200-240V

Sound Level: <50dB



Multi-Motor

| 3-Stage | Enhanced Column | Square Column

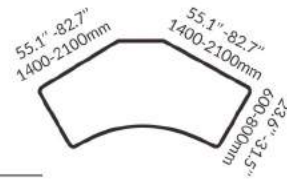

ET203-3

Height Range: 23.6"-48.4"/600-1230mm

Stroke: 24.8"/630mm

Speed: 38mm/s

Load Capacity: 330lbs/150kg

Power: 100-127V/200-240V

Sound Level: <50dB



| 3-Stage | Enhanced Column | Square Column

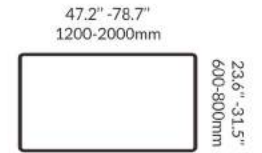

ET203-4

Height Range: 23.6"-48.4"/600-1230mm

Stroke: 24.8"/630mm

Speed: 38mm/s

Load Capacity: 275lbs/125kg

Power: 100V-240V

Sound Level: <50dB



| 3-Stage | Enhanced Column | Square Column

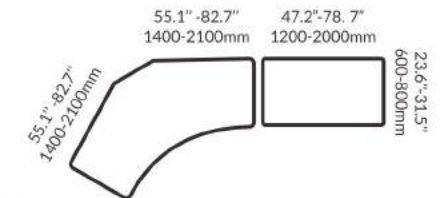

ET203-5

Height Range: 23.6"-48.4"/600-1230mm

Stroke: 24.8"/630mm

Speed: 38mm/s

Load Capacity: 330lbs/150kg(3-Desk)
275lbs/125kg(Dual Benching)

Power: 100-127V/200-240V

Sound Level: <50dB



Crank Handle

| 2-Stage | Enhanced Column | Rectangular Column

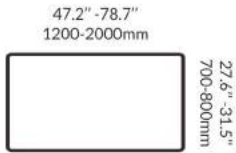

HT101

Height Range: 28.3"-48.4"/720-1230mm

Stroke: 20.1"/510mm

Speed: 4.6mm/turn

Load Capacity: 176lbs/80kg

| 2-Stage | Enhanced Column | Rectangular Column

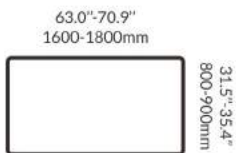

HT101F

Height Range: 26.8"-46.1"/680-1170mm

Stroke: 19.3"/490mm

Speed: 30mm/turn

Load Capacity: 110lbs/50kg

| 2-Stage | Enhanced Column | Holeless Column

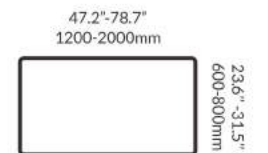

HT212

Height Range: 27.0"-45.9"/685-1165mm

Stroke: 18.9"/480mm

Speed: 16mm/turn

Load Capacity: 154lbs/70kg

| 2-Stage | Rectangular Column | Holeless Frame

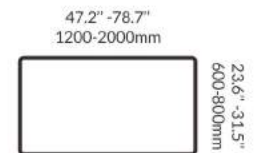

HT212H

Height Range: 27.0"-45.9"/685-1165mm

Stroke: 18.9"/480mm

Speed: 16mm/turn

Load Capacity: 154lbs/70kg

Lifting Column



Specifications

Model	L102D	L122	L126	L127	L202	L203	L221	L222
Height Range	26.4"-45.3" 670-1150mm	26.6"-45.9" 675-1165mm	26.6"-45.9" 675-1165mm	26.6"-45.9" 675-1165mm	22.8"-47.6" 580-1210mm	22.8"-47.6" 580-1210mm	22.2"-47.8" 565-1215mm	22.2"-47.8" 565-1215mm
Stroke	18.9"/480mm	19.3"/490mm	19.3"/490mm	19.3"/490mm	24.8"/630mm	24.8"/630mm	25.6"/650mm	25.6"/650mm
Speed	32mm/s	32mm/s	32mm/s	32mm/s	38mm/s	38mm/s	38mm/s	38mm/s
Load Capacity	800N	800N	800N	800N	800N	800N	800N	800N
Decibel	<50dB	<50dB	<50dB	<50dB	<50dB	<50dB	<50dB	<50dB



Specifications

Model	L223	L224	L225	L226	L227
Height Range	22.2"-47.8" 565-1215mm	22.2"-47.8" 565-1215mm	22.2"-47.8" 565-1215mm	22.2"-47.8" 565-1215mm	22.2"-47.8" 565-1215mm
Stroke	25.6"/650mm	25.6"/650mm	25.6"/650mm	25.6"/650mm	25.6"/650mm
Speed	38mm/s	38mm/s	38mm/s	38mm/s	38mm/s
Load Capacity	800N	800N	800N	800N	800N
Decibel	<50dB	<50dB	<50dB	<50dB	<50dB



Height Adjustable Desk

Conference Desk

| Single Motor | 3-Stage | Square Column

19.7"-31.5"
500-800mm



19.7"-23.6"
500-600mm

NEW



ET023

Height Range: 22.8"-48.4"/580-1230mm

Stroke: 25.6"/650mm

Speed: 38mm/s

Load Capacity: 176lbs/80kg

Power: 100V-240V

Sound Level: <50dB



Ø 19.7"-27.5"/500-700mm

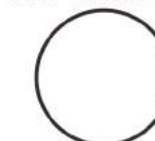

| Single Motor | 3-Stage | Round Column

NEW



ET027

Height Range: 22.8"-48.4"/580-1230mm

Stroke: 25.6"/650mm

Speed: 38mm/s

Load Capacity: 176lbs/80kg

Power: 100V-240V

Sound Level: <50dB



Mobile Desk

| Lockable Castors | Cup Holder | Standard Model



MT302M

Height Range: 29.1"-44.9"/740-1140mm

Stroke: 15.7"/400mm

Tabletop Size: 23.8" x 22.0"/605x560mm

Load Capacity: 15.4lbs/7kg

| Lockable Castors | Cup Holder | Higher Model



MT302L

Height Range: 33.5"-49.2"/850-1250mm

Stroke: 15.7"/400mm

Tabletop Size: 23.8" x 22.0"/605x560mm

Load Capacity: 15.4lbs/7kg



Gaming Desk

55.1"/1400mm



27.6"/700mm

| 2-Stage | Reversed Column | Whole Mousepad



GET102D

Height Range: 28.0"-46.9"/710-1190mm

Stroke: 18.9"/480mm

Speed: 32mm/s

Load Capacity: 220lbs/100kg

Power: 100V-240V

Sound Level: <50dB



Build your own ergonomic workstation with Loctek

Enriching your ergonomic experience via inviting more ergonomic helpers to your workplace. It is also a thing to be comfortable when typing, standing and facing a monitor for 8 to 10 hours all day. We provide various **ERGONOMIC ACCESSORIES** you may need to upgrade ergonomic experience in space-saving and body-caring.

Selecting a suitable **MONITOR ARM** is crucial for keeping a healthier watching distance and angle, which helps save desk space as well. In addition, a **DESK PRIVACY PANEL** may be needed to create a low-noise and private workspace. After that, when typing, a **KEYBOARD TRAY** allows adjusting the most comfortable position for different users. In order to keep the workplace well organized, a **CABLE MANAGEMENT TRAY** could be a smart choice for you. Another space-saving solution is a **CPU HOLDER**, which creates an ample under-desk space. As for under-desk accessories, our **ANTI-FATIGUE MAT** and file **CABINET** are professional in easing your back pain and upgrading the storage room. Apart from all the above, we are producing and outsourcing more cost-effective accessories for your health and efficiency in your workspace.



Accessory

Privacy Panel



DV101

Desktop Privacy Panel

Dimensions:
39.4"/47.2"x11.8"x0.63"
1000/1200x300x16mm

Color: ●●●●



DV103

Privacy Panel for Dual Benching

Dimensions:
47.2"/51.2"/55.1"/59.1"/63.0"x33.5"x0.98"
1200/1300/1400/1500/1600x850x25mm

Color: ●●●●



DV202

Desktop Privacy Panel

Dimensions:
46.5"x22.9"x0.71"
1180x581x18mm

Color: ●●●●



DV301

Under-Desk Privacy Panel

Dimensions:
47.2"/55.1"/59.1"x15"x0.47"
1200/1400/1500x381x12mm

Color: ●



DV302

Desktop Privacy Panel

Dimensions:
39.8"/51.1"x21.7"x0.47"
1010/1300x550x12mm

Color: ●●●●

Keyboard Tray



KT101

Adjustable Keyboard Tray

Keyboard Tray Size:
26.1"x9.6"/664x245mm
Load Capacity:
2.2lbs/1kg

Cable Management

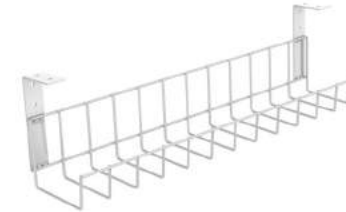

CMP501

Cable Management Tray

Dimensions:
23.6"x4.7"x6.7"
600x120x170mm



CMP502

Cable Management Tray

Dimensions:
19.7"x4.8"x3.5"
500x122x90mm

CPU Holder



CH101

Under-Desk CPU Holder

Height Range:
11.2"-20.2"
285-512mm

Width Range:
5.0"-8.3"
128-210mm

Load Capacity:
33lbs/15kg

Accessory

Cabinet



CB1201

Under-Desk Cabinet with Handle

Dimensions:
15.4" x19.7" x18.9"
390x500x480mm

Color: ○●●●●●●●



CB1202

Under-Desk Cabinet

Dimensions:
15.4" x19.7" x18.9"
390x500x480mm

Color: ○



CB1301

Under-Desk Cabinet with Handle

Dimensions:
15.4" x19.7" x23.6"
390x500x600mm

Color: ○●●●●●●●



CB1302

Under-Desk Cabinet

Dimensions:
15.4" x19.7" x23.6"
390x500x600mm

Color: ○

Anti-Fatigue Mat



AFM001

Anti-Fatigue Mat

Dimensions:
32.3" x20.5" x2.0"
820x520x52mm



AFM004

Anti-Fatigue Mat with Raised Side Rails

Dimensions:
31.5" x20.4" x1.9"
800x518x48mm



AFM005

Anti-Fatigue Mat with Raised Side Rails

Dimensions:
24.4" x19.1" x2.2"
620x485x55mm

Index

What to consider when selecting a Height Adjustable Desk

Application Range

Regular	11-18, 21-42
E-Sports	49-50
Mobile Working	47-48
Co-Share Working Space	13, 16, 35-36, 39-40, 42
Conference	19-20, 45-46

Hardware Context

Electric Drive	11-40, 45-46, 49-50
Single Motor	26-28
Dual- Motor	11-13, 17-18, 21-26, 29-36
Multi-Motor	15-16, 20-21, 37-40
Manual Drive	41-42

Hardware Configuration

2-Leg (Rectangular)	11-12, 17-18, 21-32, 41-42, 49-50
2-Leg (L-shaped)	33-34
3-Leg (90°, 120°)	14-15, 37-38
4-Leg (Dual Benching)	13, 28, 35-36, 42

Accessory

Privacy Panel	53
Keyboard Tray	53
Cable Management	09-10, 54
CPU Holder	54
Mobile Cabinet	55
Anti-fatigue Standing Mat	55