

# DALI KATCH ONE

## QUICK SET-UP GUIDE



IN ADMIRATION OF MUSIC

# UNPACKING

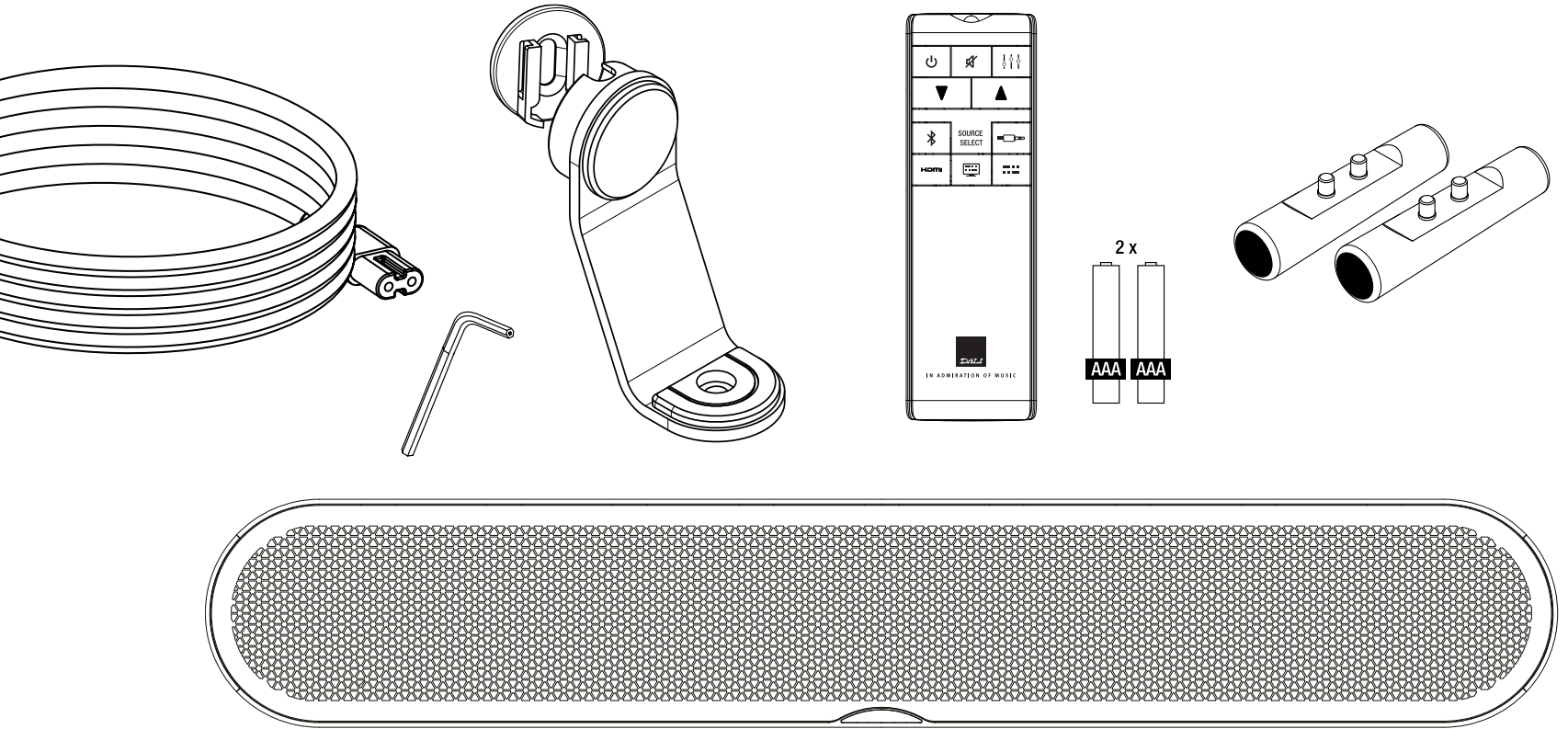

# CONNECTIONS

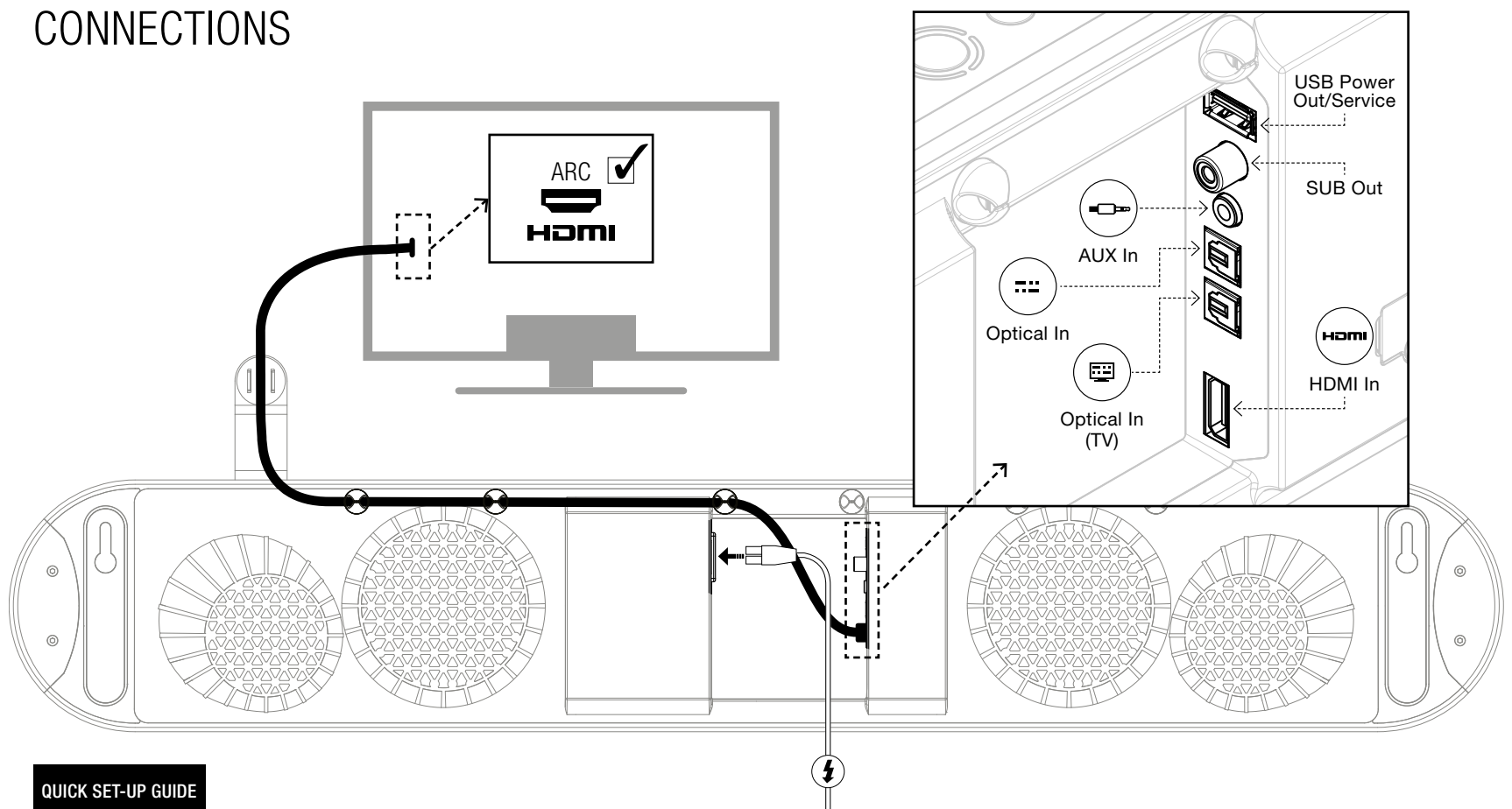

# BUTTONS

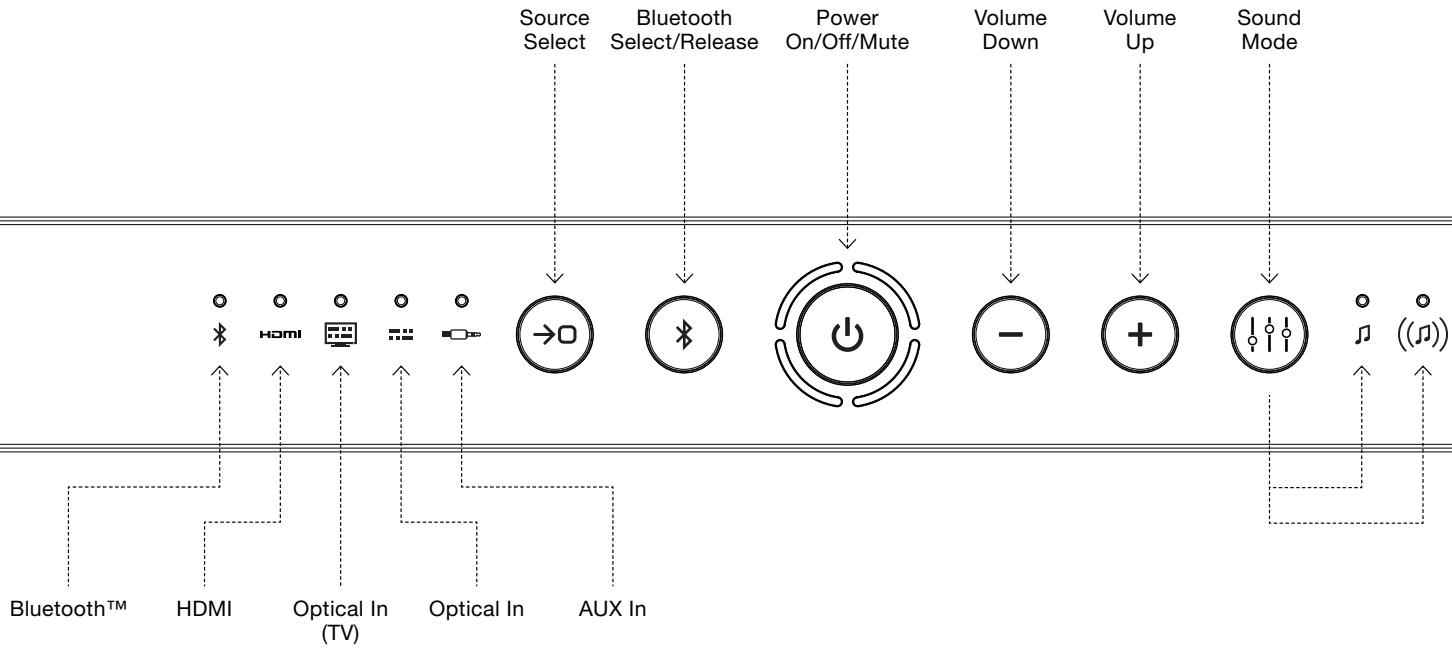

# REMOTE

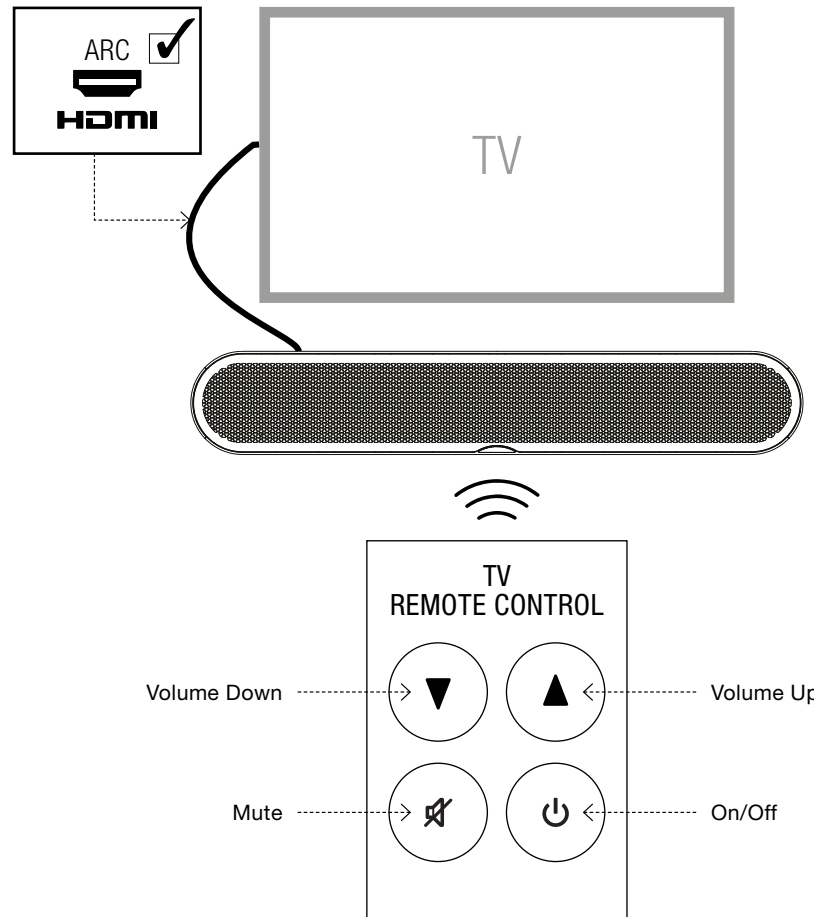
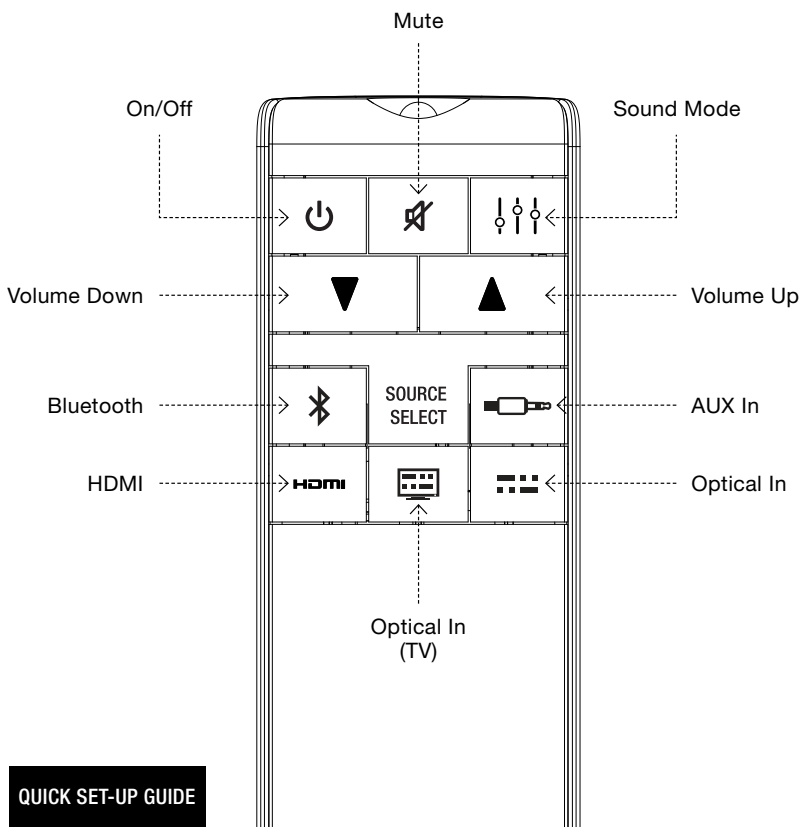

# MOUNTING

LEATHER STRAP

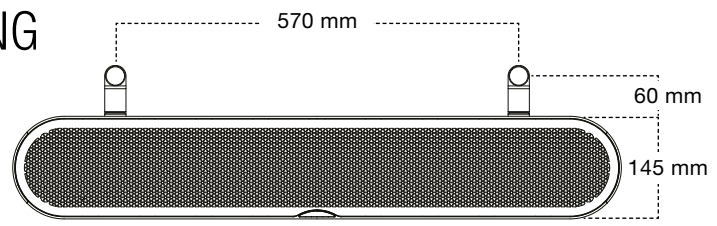

1

2 X

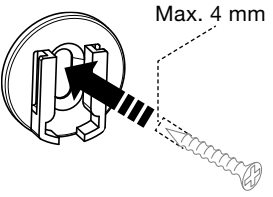

2

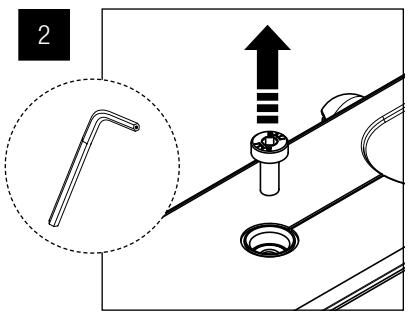

3

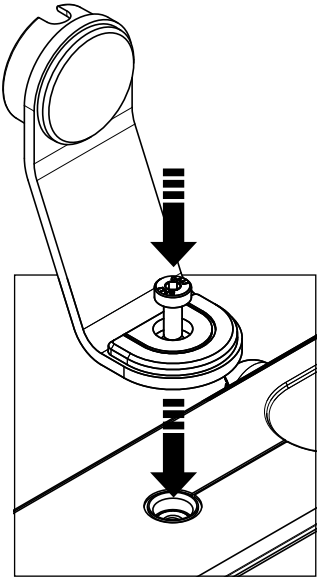

4

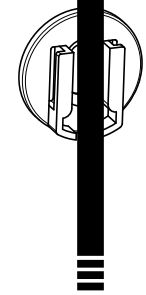

5

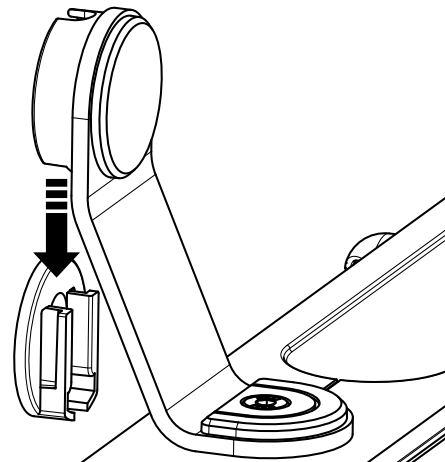

WALL KEY HOLE

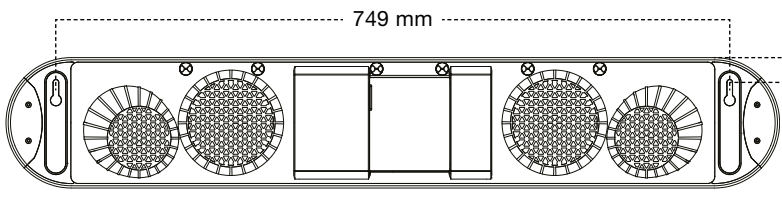

WOOD BASE

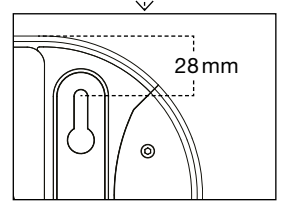

Max. 12 mm

Max. 6 mm

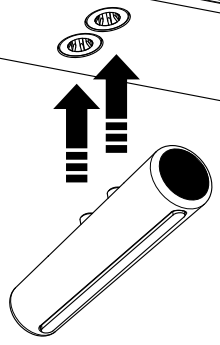
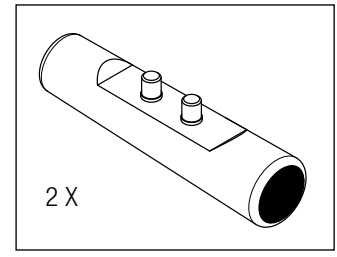
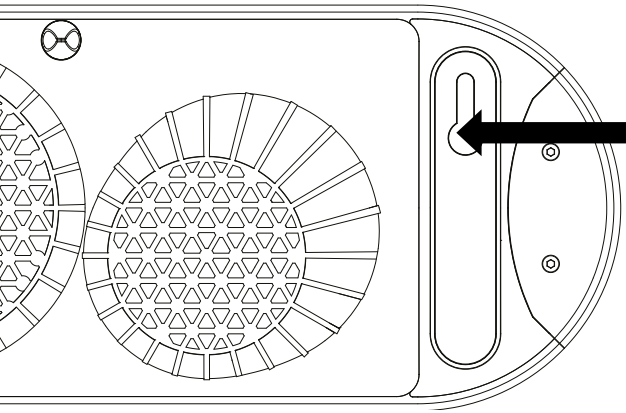



[www.dali-speakers.com/katchone](http://www.dali-speakers.com/katchone)