



Technical Data Sheet-PB

PB-3 Adjustable from 90 to 145 mm

COMPONENTS

The PB-3 is composed of 2 pieces
(PB Top + PB base)

CHARACTERISTICS

Top: \varnothing 170 mm, 227 cm²

Base: \varnothing 197 mm, 305 cm²

Weight: 492 gr

Height adjustable from 90 to 145 mm

With addition of U-PH5 slope corrector, adjustable in height from 104 to 159 mm and slope from 0 to 5%

MATERIAL

Copolymer polypropylene (CPP)

Composition: +/-80% first grade pre-selected recycled PPC, and +/-20% Talc + Masterbatch black

Designed and manufactured in Europe

Use of recycled materials exclusively of EU origin

Resistant to weathering, sea salts, algae and a wide range of chemicals

Temperature range: -30 C° to +80 C°

PACKAGING

Pieces per carton: 24 pcs

Carton weight: 12,71 kg

Carton dimension: 600 x 400 x 280 mm

Cartons per pallet: 25 pcs

Pieces per pallet: 600 pcs

Pallet dimensions: 100 x 120 x 220 cm

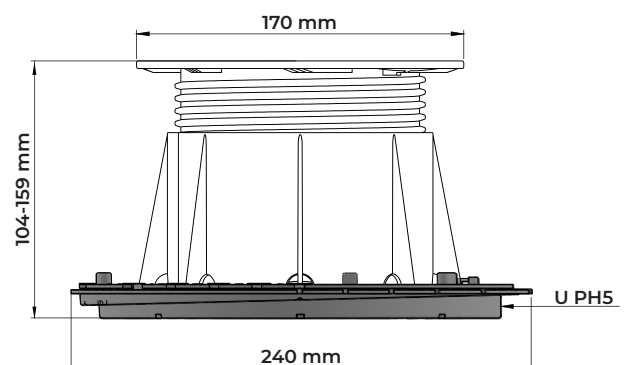
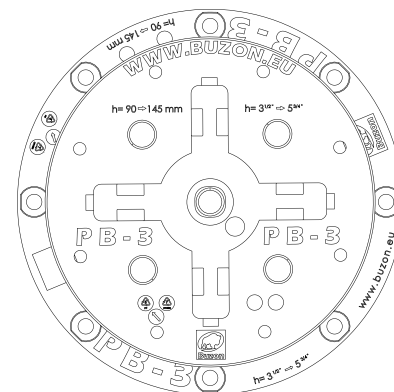
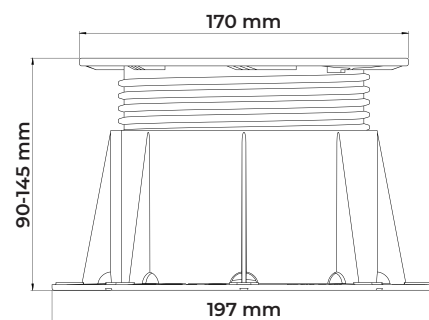

APPLICATIONS

Buzon pedestals can be used for a wide range of outdoor applications, such as terraces, pool decks and water features, in landscape areas and on rooftops... Finishing materials can be freely specified by the designer. Accessories are available for applications with various outdoor finishes, such as granite stone pavers, composite / timber decking, ceramic tiles and fibreglass or metal grating panels. Buzon pedestals can be installed on a wide range of solid and stable substrates, such as concrete slabs, cement screeds, waterproof membranes, insulation panels.

Batten Holder



Aluminium Rail Holder



Spacer Tabs



Height:
17 mm

Thickness:
2, 3 and 4,5mm

Shims



U-E10 (T- 1mm)
U-E20 (T- 2mm)

COMPRESSION TEST*

Performed on the full (1/1), half (1/2) and quarter (1/4) surface of the head (1kN= 1kg/F= 224,8 lbF)

Position	Height (mm)	Yield strength** (kN)	Yield strength (lbF)	Breaking load (kN)	Breaking load (lbF)
1/1	145	7,6 (760kg)	1708	15,83 (1583kg)	3558
1/2	145	5,7 (570kg)	1259	11,19 (1119kg)	2515
1/4	145	2,9 (290kg)	652	5,92 (592kg)	1331

* Tests carried out by SIRRIS

** The yield point is the stress from which a material stops deforming in an elastic, reversible manner and thus begins to irreversibly deform (ISO472 :2013)

SAFETY INSTRUCTIONS

Buzon pedestals are designed to support external raised floors for pedestrian traffic only and are not designed to support or be subjected to moving and/or vibrating machinery & equipment, including maintenance, cleaning vehicles, automobiles and other similar equipment.



Buzon has a policy of continuous improvement and reserves the right to modify, revise or change the above specifications without notice. This brochure is for descriptive purpose only and is based on the product as on the date of publication of this information.

© Copyright Buzon Pedestal International SA Buzon PB® is a registered trade mark of Buzon Pedestal International SA.