

CM

Installation and operating instructions



Installation and operating instructions
<http://net.grundfos.com/qr/i/95121197>



Quick Guide (CM)
<http://net.grundfos.com/qr/i/95121198>



Quick Guide (CM Self-priming)
<http://net.grundfos.com/qr/i/98503799>

English (GB) Installation and operating instructions

Original installation and operating instructions

These installation and operating instructions describe Grundfos CM pumps.

Sections 1-4 give the information necessary to be able to unpack, install and start up the product in a safe way.

Sections 5-10 give important information about the product, as well as information on service, fault finding and disposal of the product.

CONTENTS

	Page
1. General information	2
1.1 Symbols used in this document	2
2. Receiving the product	3
3. Installing the product	3
3.1 Mechanical installation	3
3.2 Installation of the pump	3
3.3 Pipes	4
3.4 Alternative connection positions	5
3.5 Terminal box positions	5
3.6 Avoiding condensation in the motor	5
3.7 Electrical connection	6
4. Starting up the product	7
4.1 Non-self-priming pumps	7
4.2 Self-priming pumps	8
4.3 Checking the direction of rotation	9
5. Product introduction	9
5.1 Applications	9
5.2 Identification	9
6. Maintaining the product	10
6.1 Contaminated products	11
6.2 Service documentation	11
7. Taking the product out of operation	11
7.1 Cleaning	11
7.2 Frost protection	11
7.3 Taking the product permanently out of operation	11
8. Fault finding the product	12
9. Technical data	14
9.1 Enclosure class	14
9.2 Sound pressure level	14
9.3 Ambient temperature	14
9.4 Maximum system pressure and permissible liquid temperature	14
9.5 Minimum inlet pressure	15
9.6 Maximum inlet pressure	15
10. Disposing of the product	15

The use of this product requires experience with and knowledge of the product.

Persons with reduced physical, sensory or mental capabilities must not use this product, unless they are under supervision or have been instructed in the use of the product by a person responsible for their safety.

Children must not use or play with this product.



1. General information

1.1 Symbols used in this document

1.1.1 Warnings against hazards involving risk of death or personal injury

DANGER



Indicates a hazardous situation which, if not avoided, will result in death or serious personal injury.

WARNING



Indicates a hazardous situation which, if not avoided, could result in death or serious personal injury.

CAUTION



Indicates a hazardous situation which, if not avoided, could result in minor or moderate personal injury.

The text accompanying the three hazard symbols DANGER, WARNING and CAUTION is structured in the following way:

SIGNAL WORD



Description of hazard

Consequence of ignoring the warning.
- Action to avoid the hazard.



Prior to installation, read this document. Installation and operation must comply with local regulations and accepted codes of good practice.

1.1.2 Other important notes



A blue or grey circle with a white graphical symbol indicates that an action must be taken.



A red or grey circle with a diagonal bar, possibly with a black graphical symbol, indicates that an action must not be taken or must be stopped.



If these instructions are not observed, it may result in malfunction or damage to the equipment.



Tips and advice that make the work easier.

2. Receiving the product

The weight of the product is stated on the packaging.

CAUTION

Back injury

- Minor or moderate personal injury
- Use lifting equipment which is approved for the weight of the product.
- Use a lifting method suitable for the weight of the product.
- Do not lift the product by lifting it in the packaging inlay.
- Wear personal protective equipment.



CAUTION

Crushing of limbs

- Minor or moderate personal injury
- Avoid insecure stacking of the product.



The pumps are delivered from factory in a packaging specially designed for manual transport or transport by forklift truck or a similar vehicle.

3. Installing the product

3.1 Mechanical installation

Before installing the pump, check that the pump type and parts are as ordered.



CAUTION

Hot or cold surface

- Minor or moderate personal injury
- Make sure that no one can accidentally come into contact with hot or cold surfaces.



3.2 Installation of the pump

Install the pump on a plane surface using the mounting holes in the motor base plate and a minimum of four bolts. Tighten each of the four bolts to a torque of 10 Nm.

Install the pump so that air pockets are avoided in the pump housing and pipes.

Figure 1 and the table below show the permissible pump positions.

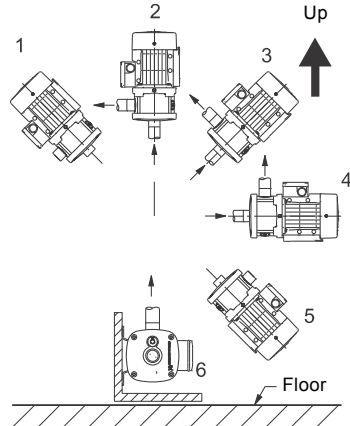

Fig. 1 Pump positions

Pump position	Non-self-priming pumps	Self-priming pumps
1	-	-
2	•	-
3	•	-
4	•	•
5	-	-
6	•	•

- Mounting in this position is allowed.

Install the pump so that inspection, maintenance and service can easily be performed.

Install the pump in a well-ventilated location.

TM05 6389 4712

3.3 Pipes

We recommend that you fit isolating valves on either side of the pump. It is thus not necessary to drain the system if the pump needs service.

If the pump is installed above the liquid level, a non-return valve must be fitted in the inlet pipe below the liquid level. See fig. 4.

Self-priming pumps

We recommend an opening pressure of the non-return valve which is lower than 0.05 bar. Otherwise, the additional resistance will reduce the suction capability of the pump.

If the pump is to be used for pumping rainwater or well water, we recommend that you fit a filter to the inlet of the inlet pipe.

The pump must not be stressed by the pipes.

Install the pipes according to the design requirements given in EN ISO 13480-3:2012. Tolerances must comply with EN ISO 13920:1996, class C.

The pipes must be correctly sized taking due account of the pump inlet pressure.

Install the pipes so that air pockets are avoided, especially on the inlet side of the pump. See fig. 2.

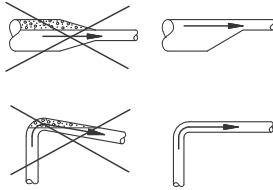

Fig. 2 Pipes

TM04 0338 0608

3.3.1 Pipe connection (non-self-priming pumps)



Take care not to damage the pump when connecting the inlet and outlet pipes.
Torque: 50-60 Nm. The stated torque must not be exceeded.

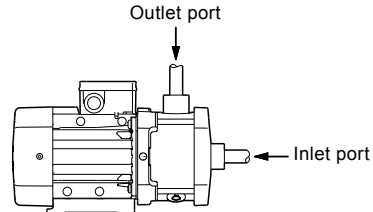

Fig. 3 Inlet and outlet ports

TM04 0358 1008

3.3.2 Pipe connection (self-priming pumps)

The pump must be installed correctly to ensure that it can self-prime.

Take the following precautions:

See fig. 4.

- The minimum height from the centre of the inlet port to the first tapping point (H_1) must be observed. If a pressure manager is installed in the system, H_1 is the height from the centre of the pump inlet port to the pressure manager. Minimum heights appear from the table below.
- The inlet pipe must be at least 0.5 metres below the liquid level (H_3).



For optimum suction capability, the pump must be located near the well or tank to ensure that the inlet pipe is as short as possible. This will reduce the self-priming time, especially in the case of a high suction lift.

We recommend that you install a filling plug in the outlet pipe. This facilitates liquid filling before startup. See fig. 4, pos. A.

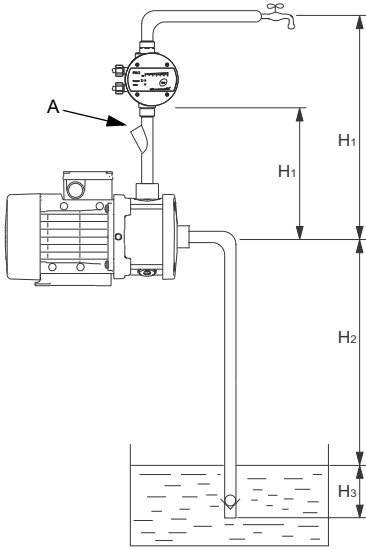

Fig. 4 Recommended pipes for a self-priming pump

TM05 8415 2313

Suction lift (H ₂) [m]	Minimum height (H ₁) [m]
4	0.2
5	0.35
6	0.5
7	0.6
8	0.7

3.4 Alternative connection positions

The pump is available with various connection positions on special request. See fig. 5.

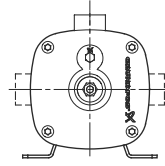

Fig. 5 Alternative connection positions

Self-priming pumps

These pumps are only available with the outlet port pointing upwards, i.e. in the same direction as the filling hole.

3.5 Terminal box positions

The pump is available with various terminal box positions on special request. See fig. 6.

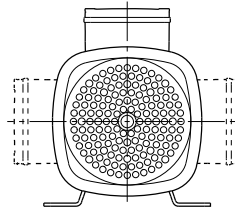

Fig. 6 Terminal box positions

TM04 0357 1008

3.6 Avoiding condensation in the motor

If the liquid temperature falls below the ambient temperature, condensation may form in the motor during standstill. Condensation can occur in moist surroundings or areas with high humidity.

In such cases, use a motor suitable for condensing environments such as an IPX5 motor available from Grundfos.

Alternatively, open the bottom drain hole in the motor flange by removing the plug. See fig. 7. This reduces the motor enclosure class to IPX5.

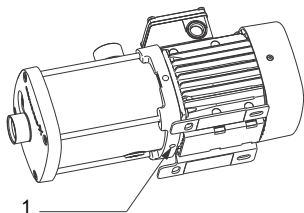

Fig. 7 Motor drain plug

TM06 3860 1015

Pos.	Description
------	-------------

1	Motor drain plug
---	------------------

The open drain hole helps prevent condensation in the motor as it makes the motor self-venting and allows water and humid air to escape.

When you install the pump outdoors, provide the motor with a cover to avoid condensation. See fig. 8.

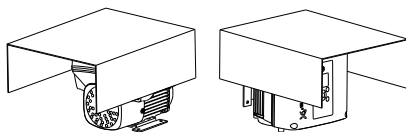

Fig. 8 Examples of covers (not supplied by Grundfos)

TM05 3496 3512

3.7 Electrical connection

Carry out the electrical connection according to local regulations.

Check that the supply voltage and frequency correspond to the values stated on the nameplate.

DANGER

Electric shock

Death or serious personal injury

- Before starting any work on the product, make sure that the power supply has been switched off and that it cannot be accidentally switched on.
- The pump must be connected to an external all-pole main switch according to local regulations.
- The product must be earthed and protected against indirect contact in accordance with local regulations.
- Wires connected to supply terminals, must be separated from each other and from the supply by reinforced insulation.



3.7.1 Power supply cable

In order to comply with the EN 60335-1 standard, the power supply cable must as a minimum be rated for an operating temperature of 105 °C (221 °F).

3.7.2 Motor protection

Single-phase motors, 1 x 115 / 230 V, 60 Hz

These motors do not incorporate motor protection and must be connected to a motor-protective circuit breaker which can be manually reset.

Set the motor-protective circuit breaker to maximum 1.15 x I_{1/1}.

Other single-phase motors

These motors have built-in current- and temperature-dependent motor protection in accordance with IEC 60034-11 and require no further motor protection. The motor protection is of the TP 211 type which reacts to both slow- and quick-rising temperatures. The motor protection is automatically reset.

Three-phase motors up to 3 kW

These motors must be connected to a motor-protective circuit breaker which can be manually reset.

Set the motor-protective circuit breaker to maximum 1.15 times full-load current.

Three-phase motors of 3 kW and up

These motors have built-in thermistors (PTC)*. The thermistors are designed according to DIN 44082. The motor protection is of the TP 211 type which reacts to both slow- and quick-rising temperatures.

* Applies only to motors for the following supply voltages:

- 3 x 200 V / 346 V, 50 Hz
- 3 x 200-220 V / 346-380 V, 60 Hz
- 3 x 220-240 V / 380-415 V, 50 Hz.

Motors for other supply voltages must be connected to a motor-protective circuit breaker as described for three-phase motors up to 3 kW.

3.7.3 Connection of wires in terminal box

Carry out the electrical connection as shown in the diagram inside the terminal box cover.

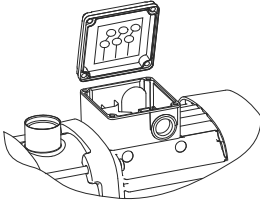

Fig. 9 Wiring diagram

3.7.4 Frequency converter operation

You can connect three-phase motors to a frequency converter.

Depending on the frequency converter type, this may cause increased acoustic noise from the motor. Furthermore, it may cause the motor to be exposed to detrimental voltage peaks.



MG 71- and MG 80-based motors have no phase insulation* and must therefore be protected against voltage peaks higher than 650 V (peak value) between the supply terminals.

* MG 71- and MG 80-based motors with phase insulation are available on request.

The above disturbances, i.e. both increased acoustic noise and detrimental voltage peaks, can be eliminated by fitting an LC filter between the frequency converter and the motor.

For further information, please contact the frequency converter supplier or Grundfos.

Self-priming pumps

If the pump is connected to a frequency converter, operation at low speed may cause the internal recirculation valve to open. This will result in a drop in pressure and flow.

4. Starting up the product



If there is a risk of condensation in the motor, remove the motor drain plug before startup and keep the drain hole open during operation. See fig. 7.

4.1 Non-self-priming pumps



Do not start the pump until it has been filled with liquid.

4.1.1 Liquid filling

CAUTION



Hot or cold liquid

Minor or moderate personal injury

- Wear personal protective equipment.
- Pay attention to the direction of the vent hole when you fill the pump with liquid and vent it.
- Make sure that no persons are hurt by the escaping liquid.



Pay attention to the direction of the vent hole during liquid filling and venting. Make sure that the escaping liquid does not cause damage to the motor or other components.

1. Close the isolating valve on the outlet side of the pump.
2. Open the isolating valve in the inlet pipe completely before starting the pump.
3. Remove the filling plug. See fig. 10.
4. Fill the pump housing and the inlet pipe completely with liquid until a steady stream of liquid runs out of the filling hole.
5. Fit and tighten the filling plug.
6. Start the pump and slowly open the outlet isolating valve while the pump is running. This ensures venting and pressure buildup during startup.



The outlet isolating valve must be opened immediately after startup of the pump. Otherwise, the temperature of the pumped liquid may become too high and cause damage to the equipment.

TM03 8781 1008

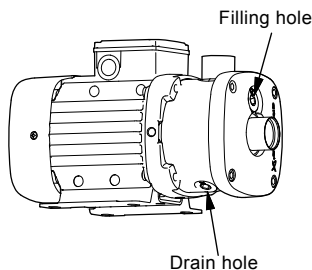

Fig. 10 Position of filling hole and drain hole



If it is difficult for the pump to build up pressure, it may be necessary to repeat steps 1 to 6.

4.2 Self-priming pumps



Do not start the pump until it has been filled with liquid.

4.2.1 Liquid filling

CAUTION

Hot or cold liquid

Minor or moderate personal injury

- Wear personal protective equipment.
- Pay attention to the direction of the vent hole when you fill the pump with liquid and vent it.
- Make sure that no persons are hurt by the escaping liquid.



Pay attention to the direction of the vent hole during liquid filling and venting. Make sure that the escaping liquid does not cause damage to the motor or other components.

1. Make sure that the outlet pipe is empty and that the height from the centre of the inlet port to the first tapping point (H_1) meets the requirements. See section 3.3.2 *Pipe connection (self-priming pumps)*.
2. Open the isolating valves in the inlet and outlet pipes.
3. Open a tap close to the pump so that air can escape.
4. Remove the filling plug in the pump. See fig. 11.
5. If a filling plug has been installed in the outlet pipe, remove this plug and use this hole for filling. Otherwise, use the filling hole in the pump.

TM03 8774 1008

6. Fill the pump housing and the inlet pipe completely with liquid until a steady stream of liquid runs out of the filling hole.
7. Fit and tighten the filling plug(s).
8. Start the pump and wait until liquid is pumped. If you have used the filling hole in the pump, it may be necessary to repeat steps 1 to 8 to ensure that the pump is completely filled with liquid.



If connected to a frequency converter, the pump must run at maximum speed (3450 min^{-1}) during startup.

9. If the pump does not operate properly after several start attempts, see section 8. *Fault finding the product*.

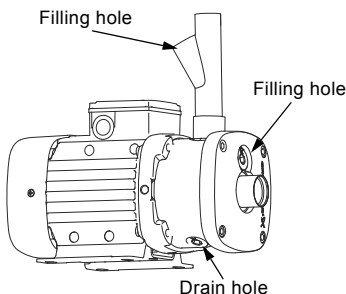

Fig. 11 Position of filling holes and drain hole



The pump is allowed to run for 5 minutes to attempt to suck liquid. If the pump does not build up pressure and flow, repeat steps 1 to 8.

TM05 8169 2013

4.3 Checking the direction of rotation

The description below applies to three-phase motors only.

The motor fan cover has an installation indicator. See fig. 12. Based on the motor cooling air, it indicates the direction of rotation of the motor.

Before you start the motor for the first time or if the position of the installation indicator has been changed, check that the installation indicator is working properly for instance by moving the indicator field with a finger.

To determine whether the direction of rotation is correct or wrong, compare the indication with the table below.

Indicator field	Direction of rotation
Black	Correct
White/reflecting	Wrong*

* To reverse the direction of rotation, switch off the power supply and interchange any two of the incoming supply wires.

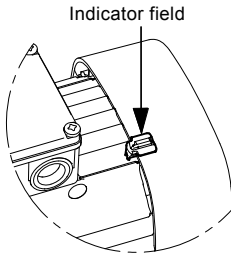

Fig. 12 Installation indicator

You can place the indicator in various positions on the motor, but do not place it between the cooling fins close to the screws that hold the fan cover.

The correct direction of rotation is also shown by arrows on the motor fan cover.

TM04 0360 1008

5. Product introduction

5.1 Applications

The pumps are horizontal, multistage centrifugal pumps designed for pumping of clean, thin and non-flammable liquids, not containing solid particles or fibres that may attack the pump mechanically or chemically.

5.2 Identification

5.2.1 Nameplates for the pump

The pump nameplates are positioned on the motor fan cover or terminal box.

Nameplate with pump data

The data and information on the pump nameplate are described in the table below. See the nameplate in fig. 1 on page 16.

Pos.	Description
1	Pump type
2	Pump model
3	Maximum ambient temperature
4	Temperature class
5	Minimum efficiency index
6	Maximum system pressure
7	Maximum liquid temperature
8	Hydraulic efficiency at best efficiency point
9	Insulation class
10	Motor protection
11	Rated flow
12	Head at rated flow
13	Maximum head

Nameplate with approval marks

The data and information on the pump nameplate are described in the table below. See the nameplate in fig. 2 on page 16.

Pos.	Description
1	CE mark
2	EAC mark
3	PSE mark
4	cULus mark
5	UL mark
6	cURus mark
7	Company name and address
8	Country of manufacture

5.2.2 Nameplate for the motor

The motor name plate is positioned on the motor cooling fins.

The data and information on the motor nameplate are described in the table below. See the nameplate in fig. 3 on page 16.

Pos.	Description
1	Capacitor size and voltage
2	50 Hz motor efficiency at rated work point
3	50 Hz power factor
4	50 Hz output power in kW
5	Frequency
6	Number of phases
7	50 Hz output power in hp
8	50 Hz maximum current
9	50 Hz full-load current
10	50 Hz rated voltage
11	Motor type
12	50 Hz rated speed
13	Frequency
14	60 Hz output power in kW
15	NEMA enclosure class
16	60 Hz output power in hp
17	60 Hz power factor
18	60 Hz motor efficiency at rated work point
19	Part number
20	Factory code
21	Production date (year and week)
22	Country of origin
23	60 Hz rated voltage
24	60 Hz full-load current
25	60 Hz maximum current
26	60 Hz rated speed
27	IEC duty cycle
28	Number of poles
29	IEC enclosure class
30	Insulation class
31	NEMA enclosure type
32	Motor duty class
33	Maximum ambient temperature
34	NEMA locked-rotor code
35	NEMA design class
37	CC122B mark
38	CE mark
39	cURus mark

6. Maintaining the product

DANGER

Electric shock



- Death or serious personal injury
- Before starting any work on the product, make sure that the power supply has been switched off and that it cannot be accidentally switched on.

WARNING

Corrosive liquids



- Death or serious personal injury
- Wear personal protective equipment.

WARNING

Toxic liquids



- Death or serious personal injury
- Wear personal protective equipment.



CAUTION

Hot or cold liquid



- Minor or moderate personal injury
- Wear personal protective equipment.

CAUTION

Back injury



- Minor or moderate personal injury
- Use lifting equipment which is approved for the weight of the product.
 - Use a lifting method suitable for the weight of the product.
 - Wear personal protective equipment.

The internal pump parts are maintenance-free. You must keep the motor clean in order to ensure adequate cooling of the motor. If the pump is installed in dusty environments, clean the pump regularly. Take the enclosure class of the motor into account when cleaning.

The motor has maintenance-free, greased-for-life bearings.



- Before startup after a period of inactivity, the pump and the inlet pipe must be completely filled with liquid. See section 4. *Starting up the product.*

6.1 Contaminated products

CAUTION



Biological hazard

- Minor or moderate personal injury
- Flush the product thoroughly with clean water and rinse the product parts in water after dismantling

The product will be classified as contaminated if it has been used for a liquid which is injurious to health or toxic.

Before the pump is returned to Grundfos for service, the safety declaration at the end of these instructions must be filled in by authorised persons and attached to the pump in a visible position.

If Grundfos is requested to service the pump, it must be cleaned before it is returned.

If proper cleaning is not possible, all relevant information about the pumped liquid must be provided.

If the above is not fulfilled, Grundfos can refuse to accept the pump for service.

Possible costs of returning the pump are to be paid by the customer.

The safety declaration can be found at the end of these instructions (only in English).

6.2 Service documentation

Service documentation is available in Grundfos Product Center (<http://product-selection.grundfos.com/>).

If you have any questions, please contact the nearest Grundfos company or service workshop.

7. Taking the product out of operation

7.1 Cleaning

Prior to a long period of inactivity, flush the pump with clean water to prevent corrosion and deposits in the pump.

Use acetic acid to remove possible lime deposits from the pump.

7.2 Frost protection

Pumps which are not being used during periods of frost must be drained to avoid damage.

Remove the filling and drain plugs from the pump. See fig. 10.

Do not refit the plugs until the pump is taken into operation again.

7.3 Taking the product permanently out of operation

Observe the following if the pump is to be permanently taken out of operation and removed from the pipe system.

WARNING



Corrosive liquids

- Death or serious personal injury
- Wear personal protective equipment.

WARNING



Toxic liquids

- Death or serious personal injury
- Wear personal protective equipment.



CAUTION

Hot or cold liquid

- Minor or moderate personal injury
- Wear personal protective equipment.



CAUTION

Back injury



- Minor or moderate personal injury
- Use lifting equipment which is approved for the weight of the product.
 - Use a lifting method suitable for the weight of the product.
 - Wear personal protective equipment.

8. Fault finding the product

DANGER

Electric shock

- Death or serious personal injury
- Before starting any work on the product, make sure that the power supply has been switched off and that it cannot be accidentally switched on.



WARNING

Corrosive liquids

- Death or serious personal injury
- Wear personal protective equipment.



WARNING

Toxic liquids

- Death or serious personal injury
- Wear personal protective equipment.



CAUTION

Hot or cold liquid

- Minor or moderate personal injury
- Wear personal protective equipment.



Fault	Cause	Remedy
1. The pump does not run.	a) Supply failure.	Switch on the switch. Check cables and cable connections for defects and loose connections.
	b) Motor protection has tripped.	See 2. a), b), c), d), e).
	c) Control-current circuit is defective.	Repair or replace the control-current circuit.
2. Motor-protective circuit breaker has tripped (trips immediately when power supply is switched on).	a) Contacts of the motor-protective circuit breaker or magnet coil are defective.	Replace the contacts of the motor-protective circuit breaker, the magnet coil or the entire motor-protective circuit breaker.
	b) Cable connection is loose or faulty.	Check cables and cable connections for defects, and replace the fuses.
	c) Motor winding is defective.	Repair or replace the motor.
	d) The pump is mechanically blocked.	Switch off the power supply, and clean or repair the pump.
	e) The setting of the motor-protective circuit breaker is too low.	Set the motor-protective circuit breaker according to the rated current of the motor ($I_{1/1}$). See the nameplate.
3. The motor-protective circuit breaker trips occasionally.	a) The setting of the motor-protective circuit breaker is too low.	See 2. e).
	b) Periodic supply fault.	See 2. b).
	c) Periodically low voltage.	Check cables and cable connections for defects and loose connections. Check that the power supply cable of the pump is correctly sized.
4. The motor-protective circuit breaker has not tripped, but the pump is inadvertently out of operation.	a) See 1. a), b), c) and 2. d).	
5. The pump performance is unstable.	a) Pump inlet pressure is too low.	Check for proper inlet conditions.
	b) Inlet pipe is partly blocked by impurities.	Remove and clean the inlet pipe.
	c) Leakage in the inlet pipe.	Remove and repair the inlet pipe.
	d) Air in the inlet pipe or pump.	Vent the inlet pipe or pump. Check for proper inlet conditions.

Fault	Cause	Remedy
6. The pump performance is unstable, and the pump is noisy.	Self-priming pumps only:	
	a) The differential pressure across the pump is too low.	Close the tap gradually until the outlet pressure is stable and the noise has ceased.
7. The pump runs, but gives no water.	a) Pump inlet pressure is too low.	See 5. a).
	b) The inlet pipe is partly clogged by impurities.	See 5. b).
	c) The foot or non-return valve is stuck in its closed position.	Remove and clean, repair or replace the valve.
	d) Leakage in the inlet pipe.	See 5. c).
	e) Air in the inlet pipe or pump.	See 5. d).
8. When startup is attempted, the pump starts, but delivers no pressure or flow.	Self-priming pumps only:	
	a) Liquid column above non-return valve in the outlet pipe prevents the pump from self-priming.	Empty the outlet pipe. Make sure that the non-return valve does not hold back liquid in the outlet pipe. Repeat the startup procedure in section 3.3.2 Pipe connection (self-priming pumps) .
	b) Inlet pipe draws in air.	Make sure that the inlet pipe is airtight from pump to liquid level. Repeat the startup procedure in section 3.3.2 Pipe connection (self-priming pumps) .
9. The pump runs, but does not deliver the rated flow.	Self-priming pumps only:	
	a) The internal valve did not close.	Close the tap gradually until a sudden rise in pressure or flow rate can be seen. Then open the tap gradually until you reach the required flow rate.
10. The pump runs backwards when switched off.	a) Leakage in the inlet pipe.	See 5. c).
	b) Foot or non-return valve is defective.	See 7. c).
	c) The foot valve is stuck in completely or partly open position.	See 7. c).
11. The pump runs with reduced performance.	a) Wrong direction of rotation.	Three-phase pumps only: Switch off the power supply with the external circuit breaker, and interchange two phases in the pump terminal box. Also, see section 4.3 Checking the direction of rotation .
	b) See 5. a), b), c), d).	

9. Technical data

9.1 Enclosure class

- IP55 (standard)
- IPx5 (with motor drain plug removed).

9.2 Sound pressure level

The sound pressure level of the pumps is lower than 70 dB(A).

9.3 Ambient temperature



Self-priming pumps:
The liquid temperature must not exceed 60 °C (140 °F).

Maximum ambient temperature	Liquid temperature
55 °C (131 °F) ²⁾	90 °C (194 °F) ^{1) + 2)}
50 °C (122 °F) ²⁾	100 °C (212 °F) ^{1) + 2)}
45 °C (113 °F)	110 °C (230 °F) ¹⁾
40 °C (104 °F)	120 °C (248 °F) ¹⁾

- 1) Only the stainless-steel variant (EN 1.4301 / AISI 304) is suitable for pumping liquids with temperatures above 90 °C (194 °F).
- 2) Does not apply for pumps with PSE approval (pumps approved for use in Japan).

9.4 Maximum system pressure and permissible liquid temperature

Material variant	Shaft seal	Permissible liquid temperature*		Maximum system pressure
Cast iron (EN-GJL-200)	AVBx	-20 to 40 °C 41 to 90 °C	(-4 to 104 °F) (105.8 to 194 °F)	10 bar (145 psi) 6 bar (87 psi)
	AQQx	-20 to 90 °C	(-4 to 194 °F)	10 bar (145 psi)
Stainless steel (EN 1.4301 / AISI 304)	AVBx	-20 to 40 °C 41 to 90 °C	(-4 to 104 °F) (105.8 to 194 °F)	10 bar (145 psi) 6 bar (87 psi)
	AQQx	-20*** to 90 °C 91 to 120 °C**	(-4 to 194 °F) (195.8 to 248 °F)	16 bar (232 psi) 10 bar (145 psi)
Stainless steel (EN 1.4401 / AISI 316)	AVBx	-20 to 40 °C 41 to 90 °C	(-4 to 104 °F) (105.8 to 194 °F)	10 bar (145 psi) 6 bar (87 psi)
	AQQx	-20*** to 90 °C 91 to 120 °C**	(-4 to 194 °F) (195.8 to 248 °F)	16 bar (232 psi) 10 bar (145 psi)

* At liquid temperatures below 0 °C (32 °F), higher motor outputs may be needed due to increased viscosity, for instance if you have added glycol to the water.

** 120 °C (248 °F) applies only if the pump has an AQQE shaft seal.

*** CM pumps for pumping liquids at temperatures below -20 °C (-4 °F) are available on request. Please contact Grundfos.

If the ambient temperature exceeds 55 °C (45 °C for pumps with PSE approval), do not fully load the motor due to the risk of overheating. In such cases, you may need to derate the motor output or use an oversize motor with a higher rated output. You can derate the CM pumps in relation to the ambient temperature without any consequence. Contact Grundfos for further information. See fig. 13.



Fig. 13 Derating in relation to the ambient temperature

TM05 7630 1313

9.5 Minimum inlet pressure

You can calculate the minimum inlet pressure "H" in metres head required during operation to avoid cavitation in the pump from the following formula:

$$H = p_b \times 10.2 - \text{NPSH} - H_f - H_v - H_s$$

$$p_b = \text{Barometric pressure in bar.}$$

The barometric pressure can be set to 1 bar.

In closed systems, p_b indicates the system pressure in bar.

$$\text{NPSH} = \text{Net Positive Suction Head in metres head. To be read from the NPSH curves on pages 17 to 19 at the highest flow rate the pump will be delivering.}$$

$$H_f = \text{Friction loss in inlet pipe in metres head.}$$

$$H_v = \text{Vapour pressure in metres head.}$$

See fig. 10, page 20.

t_m = liquid temperature.

$$H_s = \text{Safety margin} = \text{min. 0.5 metres head.}$$

If the calculated value of "H" is positive, the pump can operate with a maximum suction lift of "H" metres.

If the calculated value of "H" is negative, a minimum suction head of "H" metres is required during operation to avoid cavitation.

Example

$$p_b = 1 \text{ bar.}$$

Pump type: CM 3, 50 Hz.

Flow rate: 4 m³/h.

NPSH (from fig. 5, page 17): 3.3 metres head.

H_f = 3.0 metres head.

Liquid temperature: 90 °C.

H_v (from fig. 10, page 20): 7.2 metres head.

$$H = p_b \times 10.2 - \text{NPSH} - H_f - H_v - H_s \text{ [metres head].}$$

$$H = 1 \times 10.2 - 3.0 - 3.3 - 7.2 - 0.5 = -3.8 \text{ metres head.}$$

This means that a suction head of 3.8 metres is required during operation.

Pressure calculated in bar: $3.8 \times 0.0981 = 0.37 \text{ bar.}$

Pressure calculated in kPa: $3.8 \times 9.81 = 37.3 \text{ kPa.}$

9.6 Maximum inlet pressure

The actual inlet pressure plus the pressure when the pump is operating against a closed valve must always be lower than the maximum system pressure.

10. Disposing of the product

This product or parts of it must be disposed of in an environmentally sound way:

1. Use the public or private waste collection service.
2. If this is not possible, contact the nearest Grundfos company or service workshop.

Subject to alterations.

Appendix

Type <input type="text" value="1"/>		Tliq,max <input type="text" value="7"/> °C <input type="text" value="7"/> °F	
Model <input type="text" value="2"/>		PMax <input type="text" value="6"/> bar <input type="text" value="6"/> PSI <input type="text" value="6"/> MPa	
TAmb <input type="text" value="3"/> °C <input type="text" value="3"/> °F		TF <input type="text" value="4"/> MEI ≥ <input type="text" value="5"/> η _p (%) <input type="text" value="8"/> Insulation class <input type="text" value="9"/> <input type="text" value="10"/>	
ZHO	Q nom <input type="text" value="11"/> m ³ /h <input type="text" value="11"/> GPM	ZHN	Q nom <input type="text" value="11"/> m ³ /h <input type="text" value="11"/> GPM
	H nom <input type="text" value="12"/> m <input type="text" value="12"/> PSI		H nom <input type="text" value="12"/> m <input type="text" value="12"/> PSI
	H max <input type="text" value="13"/> m <input type="text" value="13"/> PSI		H max <input type="text" value="13"/> m <input type="text" value="13"/> PSI

TM05 6388 4712

Fig. 1 Pump nameplate with data

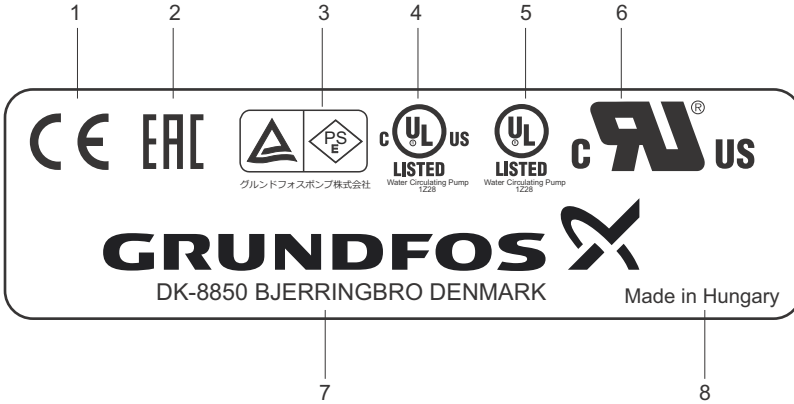

TM06 3835 4715

Fig. 2 Pump nameplate with approval marks

9861138	<input type="text" value="6"/> - MOT	Type: <input type="text" value="11"/>	Env <input type="text" value="15"/>	Model: <input type="text" value="19"/> - <input type="text" value="20"/> - <input type="text" value="21"/>	Country of origin <input type="text" value="22"/> IEC 60034
	<input type="text" value="5"/> Hz	U <input type="text" value="10"/> V <input type="text" value="13"/> Hz		U <input type="text" value="23"/> V	
	P2 <input type="text" value="4"/> kW <input type="text" value="7"/> hp	I _{v1} <input type="text" value="9"/> A P2 <input type="text" value="14"/> kW <input type="text" value="16"/> hp		I _{v1} <input type="text" value="24"/> A	
	cosφ <input type="text" value="3"/>	I _{max} <input type="text" value="8"/> A PF <input type="text" value="17"/>		I _{max} <input type="text" value="25"/> A	
Eff. <input type="text" value="2"/>	n <input type="text" value="12"/> min ⁻¹ Eff. <input type="text" value="18"/>		n <input type="text" value="26"/> min ⁻¹		
<input type="text" value="1"/>	Des: <input type="text" value="35"/> Code: <input type="text" value="34"/> AMB <input type="text" value="33"/> °C <input type="text" value="32"/> <input type="text" value="31"/>	Th.Cl. <input type="text" value="30"/> IP <input type="text" value="29"/> <input type="text" value="28"/> Pole / <input type="text" value="27"/>			<input type="text" value="37"/> <input type="text" value="38"/> <input type="text" value="39"/>

TM06 3826 1015

Fig. 3 Nameplate for the motor

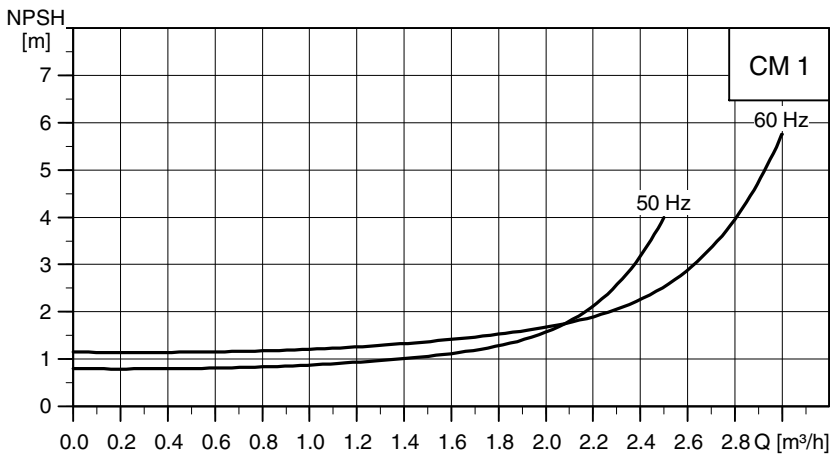

Fig. 4 NPSH curves for CM 1

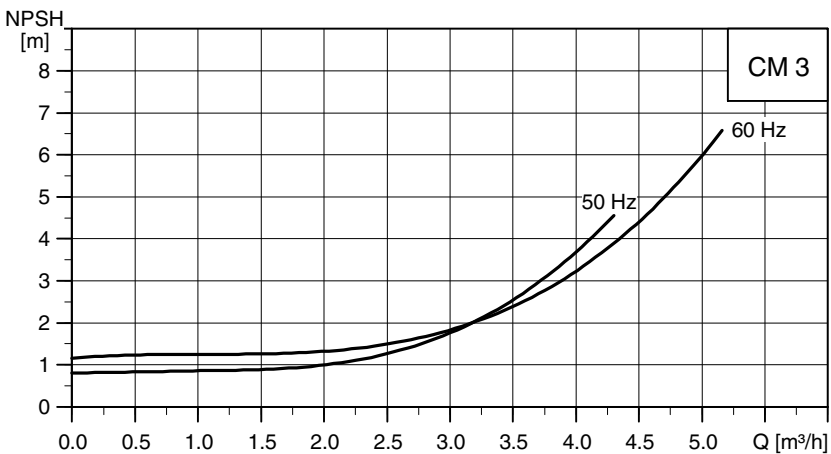

Fig. 5 NPSH curves for CM 3

TM04_0458_0309

TM04_0459_0309

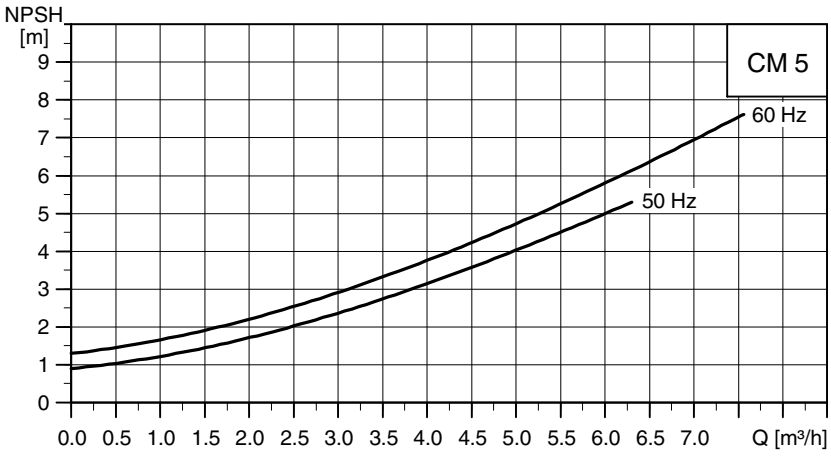

Fig. 6 NPSH curves for CM 5

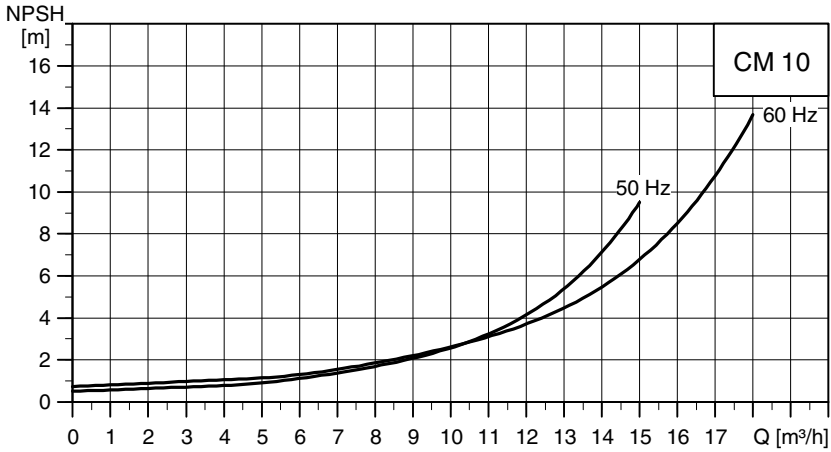

Fig. 7 NPSH curves for CM 10

TM04 0460 0309

TM04 0461 0309

TM04 0462 0309

TM04 0463 0309

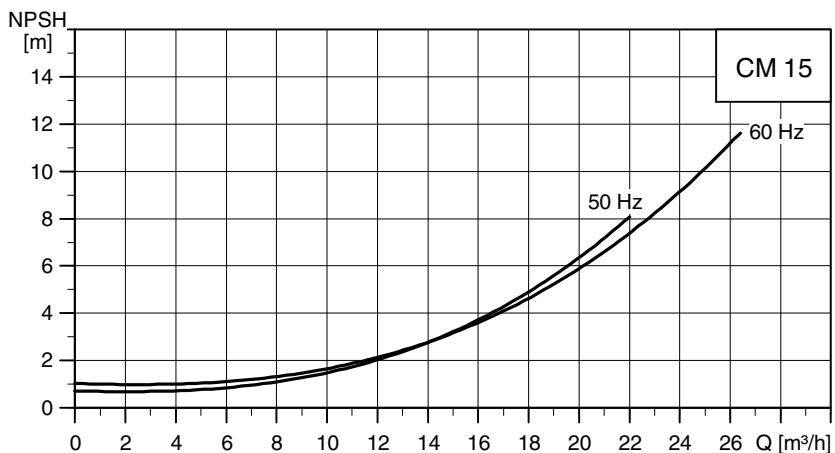

Fig. 8 NPSH curves for CM 15

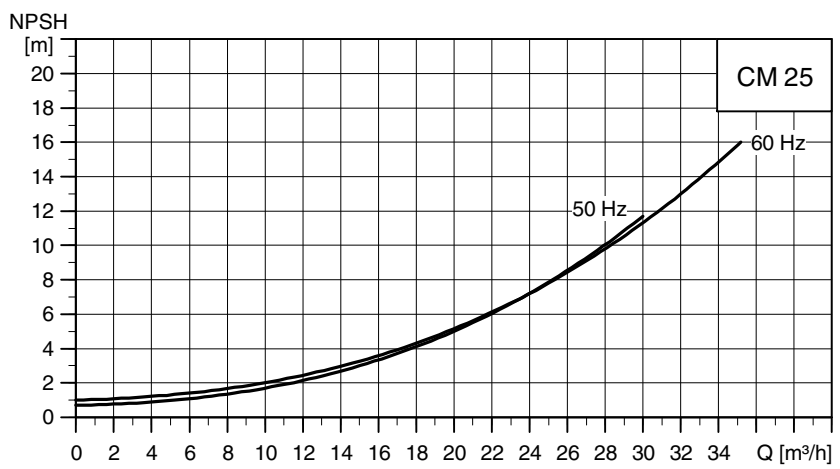

Fig. 9 NPSH curves for CM 25

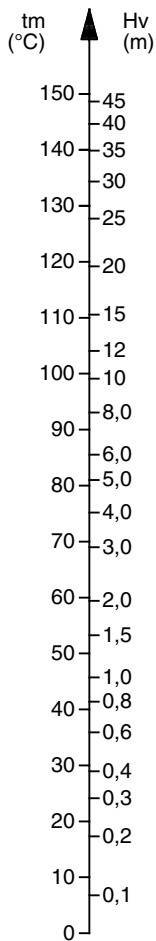

Fig. 10 Vapour pressure

TM00 3037 0800

Safety declaration

Please copy, fill in and sign this sheet and attach it to the pump returned for service.

Media and application

Which media has the pump been used for: _____

In which application has the pump been used: _____

Fault description

If possible please make a circle around the faulty part.
(In case of an electrical fault, please mark the terminal box.)

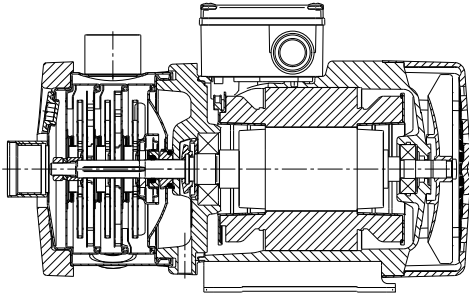

TM04 0359 1008

Please give a short description of the fault:

We hereby declare that this product is free from hazardous chemicals, biological and radioactive substances.

Date and signature

Company stamp

Argentina

Bombas GRUNDFOS de Argentina S.A.
Ruta Panamericana km. 37.500 Centro
Industrial Garin
1619 Garin Pcia. de B.A.
Phone: +54-3327 414 444
Telefax: +54-3327 45 3190

Australia

GRUNDFOS Pumps Pty. Ltd.
P.O. Box 2040
Regency Park
South Australia 5942
Phone: +61-8-8461-4611
Telefax: +61-8-8340 0155

Austria

GRUNDFOS Pumpen Vertrieb
Ges.m.b.H.
Grundfosstraße 2
A-5082 Grödig/Salzburg
Tel.: +43-6246-883-0
Telefax: +43-6246-883-30

Belgium

N.V. GRUNDFOS Bellux S.A.
Boomsesteenweg 81-83
B-2630 Aartselaar
Tél.: +32-3-870 7300
Télécopie: +32-3-870 7301

Belarus

Представительство ГРУНДФОС в
Минске
220125, Минск
ул. Шафарнянская, 11, оф. 56, БЦ
«Порт»
Тел.: +7 (375 17) 286 39 72/73
Факс: +7 (375 17) 286 39 71
E-mail: minsk@grundfos.com

Bosnia and Herzegovina

GRUNDFOS Sarajevo
Zmaj od Bosne 7-7A,
BH-71000 Sarajevo
Phone: +387 33 592 480
Telefax: +387 33 590 465
www.ba.grundfos.com
e-mail: grundfos@bih.net.ba

Brazil

BOMBAS GRUNDFOS DO BRASIL
Av. Humberto de Alencar Castelo
Branco, 630
CEP 09850 - 300
São Bernardo do Campo - SP
Phone: +55-11 4393 5533
Telefax: +55-11 4343 5015

Bulgaria

Grundfos Bulgaria EOOD
Slatina District
Iztochna Tangenta street no. 100
BG - 1592 Sofia
Tel. +359 2 49 22 200
Fax. +359 2 49 22 201
email: bulgaria@grundfos.bg

Canada

GRUNDFOS Canada Inc.
2941 Brighton Road
Oakville, Ontario
L6H 6C9
Phone: +1-905 829 9533
Telefax: +1-905 829 9512

China

GRUNDFOS Pumps (Shanghai) Co. Ltd.
10F The Hub, No. 33 Suhong Road
Minhang District
Shanghai 201106
PRC
Phone: +86 21 612 252 22
Telefax: +86 21 612 253 33

COLOMBIA

GRUNDFOS Colombia S.A.S.
Km 1.5 vía Siberia-Cota Conj. Potrero
Chico,
Parque Empresarial Arcos de Cota Bod.
1A.
Cota, Cundinamarca
Phone: +57(1)-2913444
Telefax: +57(1)-8764586

Croatia

GRUNDFOS CROATIA d.o.o.
Buzinski prilaz 38, Buzin
HR-10010 Zagreb
Phone: +385 1 6595 400
Telefax: +385 1 6595 499
www.hr.grundfos.com

GRUNDFOS Sales Czechia and Slovakia s.r.o.

Čajkovského 21
779 00 Olomouc
Phone: +420-585-716 111

Denmark

GRUNDFOS DK A/S
Martin Bachs Vej 3
DK-8850 Bjerringbro
Tlf.: +45-87 50 50 50
Telefax: +45-87 50 51 51
E-mail: info_GDK@grundfos.com
www.grundfos.com/DK

Estonia

GRUNDFOS Pumps Eesti OÜ
Peterburi tee 92G
11415 Tallinn
Tel: + 372 606 1690
Fax: + 372 606 1691

Finland

OY GRUNDFOS Pumput AB
Trukkikuja 1
FI-01360 Vantaa
Phone: +358-(0) 207 889 500

France

Pompes GRUNDFOS Distribution S.A.
Parc d'Activités de Chesnes
57, rue de Malacombe
F-38290 St. Quentin Fallavier (Lyon)
Tél.: +33-4 74 82 15 15
Télécopie: +33-4 74 94 10 51

Germany

GRUNDFOS GMBH
Schlüterstr. 33
40699 Erkrath
Tel.: +49-(0) 211 929 69-0
Telefax: +49-(0) 211 929 69-3799
e-mail: infoservice@grundfos.de
Service in Deutschland:
e-mail: kundendienst@grundfos.de

Greece

GRUNDFOS Hellas A.E.B.E.
20th km. Athinon-Markopoulou Av.
P.O. Box 71
GR-19002 Peania
Phone: +0030-210-66 83 400
Telefax: +0030-210-66 46 273

Hong Kong

GRUNDFOS Pumps (Hong Kong) Ltd.
Unit 1, Ground floor
Siu Wai Industrial Centre
29-33 Wing Hong Street &
68 King Lam Street, Cheung Sha Wan
Kowloon
Phone: +852-27861706 / 27861741
Telefax: +852-27858664

Hungary

GRUNDFOS Hungária Kft.
Park u. 8
H-2045 Törökbálint,
Phone: +36-23 511 110
Telefax: +36-23 511 111

India

GRUNDFOS Pumps India Private
Limited
118 Old Mahabalipuram Road
Thoraiakkam
Chennai 600 096
Phone: +91-44 2496 6800

Indonesia

PT. GRUNDFOS POMPA
Graha Intirub Lt. 2 & 3
Jln. Cililitan Besar No.454. Makasar,
Jakarta Timur
ID-Jakarta 13650
Phone: +62 21-469-51900
Telefax: +62 21-460 6910 / 460 6901

Ireland

GRUNDFOS (Ireland) Ltd.
Unit A, Merrywell Business Park
Ballymount Road Lower
Dublin 12
Phone: +353-1-4089 800
Telefax: +353-1-4089 830

Italy

GRUNDFOS Pompe Italia S.r.l.
Via Gran Sasso 4
I-20060 Truccazzano (Milano)
Tel.: +39-02-95838112
Telefax: +39-02-95309290 / 95838461

Japan

GRUNDFOS Pumps K.K.
1-2-3, Shin-Miyakoda, Kita-ku,
Hamamatsu
431-2103 Japan
Phone: +81 53 428 4760
Telefax: +81 53 428 5005

Korea

GRUNDFOS Pumps Korea Ltd.
6th Floor, Aju Building 679-5
Yeoksam-dong, Kangnam-ku, 135-916
Seoul, Korea
Phone: +82-2-5317 600
Telefax: +82-2-5633 725

Latvia

SIA GRUNDFOS Pumps Latvia
Deglava biznesa centrs
Augusta Deglava iela 60, LV-1035, Rīga,
Tālr.: + 371 714 9640, 7 149 641
Faks: + 371 914 9646

Lithuania

GRUNDFOS Pumps UAB
Smolensko g. 6
LT-03201 Vilnius
Tel: + 370 52 395 430
Fax: + 370 52 395 431

Malaysia

GRUNDFOS Pumps Sdn. Bhd.
7 Jalan Peguam U1/25
Glenmarie Industrial Park
40150 Shah Alam
Selangor
Phone: +60-3-5569 2922
Telefax: +60-3-5569 2866

Mexico

Bombas GRUNDFOS de México S.A. de
C.V.
Boulevard TLC No. 15
Parque Industrial Stiva Aeropuerto
Apodaca, N.L. 66600
Phone: +52-81-8144 4000
Telefax: +52-81-8144 4010

Netherlands

GRUNDFOS Netherlands
Veluwezoom 35
1326 AE Almere
Postbus 22015
1302 CA ALMERE
Tel.: +31-88-478 6336
Telefax: +31-88-478 6332
E-mail: info_gnl@grundfos.com

New Zealand

GRUNDFOS Pumps NZ Ltd.
17 Beatrice Tinsley Crescent
North Harbour Industrial Estate
Albany, Auckland
Phone: +64-9-415 3240
Telefax: +64-9-415 3250

Norway

GRUNDFOS Pumper A/S
Strømsveien 344
Postboks 235, Leirdal
N-1011 Oslo
Tlf.: +47-22 90 47 00
Telefax: +47-22 32 21 50

Poland

GRUNDFOS Pompy Sp. z o.o.
ul. Klonowa 23
Baranowo k. Poznania
PL-62-081 Przeźmierowo
Tel: (+48-61) 650 13 00
Fax: (+48-61) 650 13 50

Portugal

Bombas GRUNDFOS Portugal, S.A.
Rua Calvet de Magalhães, 241
Apartado 1079
P-2770-153 Paço de Arcos
Tel.: +351-21-440 76 00
Telefax: +351-21-440 76 90

Romania

GRUNDFOS Pompe România SRL
Bd. Biruintei, nr 103
Pantelimon county Ilfov
Phone: +40 21 200 4100
Telefax: +40 21 200 4101
E-mail: romania@grundfos.ro

Russia

ООО Грундфос Россия
ул. Школьная, 39-41
Москва, RU-109544, Russia
Тел. (+7) 495 564-88-00 (495)
737-30-00
Факс (+7) 495 564 8811
E-mail grundfos.moscow@grundfos.com

Serbia

Grundfos Srbija d.o.o.
Omladinskih brigada 90b
11070 Novi Beograd
Phone: +381 11 2258 740
Telefax: +381 11 2281 769
www.rs.grundfos.com

Singapore

GRUNDFOS (Singapore) Pte. Ltd.
25 Jalan Tukang
Singapore 619264
Phone: +65-6681 9688
Telefax: +65-6681 9689

Slovakia

GRUNDFOS s.r.o.
Prievozská 4D
821 09 BRATISLAVA
Phona: +421 2 5020 1426
sk.grundfos.com

Slovenia

GRUNDFOS LJUBLJANA, d.o.o.
Leskovoška 9e, 1122 Ljubljana
Phone: +386 (0) 1 568 06 10
Telefax: +386 (0) 1 568 06 19
E-mail: tehnika-si@grundfos.com

South Africa

GRUNDFOS (PTY) LTD
Corner Mountjoy and George Allen
Roads
Wilbart Ext. 2
Bedfordview 2008
Phone: (+27) 11 579 4800
Fax: (+27) 11 455 6066
E-mail: lsmart@grundfos.com

Spain

Bombas GRUNDFOS España S.A.
Camino de la Fuenteçilla, s/n
E-28110 Algete (Madrid)
Tel.: +34-91-848 8800
Telefax: +34-91-628 0465

Sweden

GRUNDFOS AB
Box 333 (Lunnagårdsgatan 6)
431 24 Mölndal
Tel.: +46 31 332 23 000
Telefax: +46 31 331 94 60

Switzerland

GRUNDFOS Pumpen AG
Bruggacherstrasse 10
CH-8117 Fällanden/ZH
Tel.: +41-44-806 8111
Telefax: +41-44-806 8115

Taiwan

GRUNDFOS Pumps (Taiwan) Ltd.
7 Floor, 219 Min-Chuan Road
Taichung, Taiwan, R.O.C.
Phone: +886-4-2305 0868
Telefax: +886-4-2305 0878

Thailand

GRUNDFOS (Thailand) Ltd.
92 Chaloe Phrakiat Rama 9 Road,
Dokmai, Pravej, Bangkok 10250
Phone: +66-2-725 8999
Telefax: +66-2-725 8998

Turkey

GRUNDFOS POMPA San. ve Tic. Ltd.
Sti.
Gebze Organize Sanayi Bölgesi
İhsan dede Caddesi,
2. yol 200. Sokak No. 204
41490 Gebze/ Kocaeli
Phone: +90 - 262-679 7979
Telefax: +90 - 262-679 7905
E-mail: satis@grundfos.com

Ukraine

Бізнес Центр Європа
Столичне шосе, 103
м. Київ, 03131, Україна
Телефон: (+38 044) 237 04 00
Факс.: (+38 044) 237 04 01
E-mail: ukraine@grundfos.com

United Arab Emirates

GRUNDFOS Gulf Distribution
P.O. Box 16768
Jebel Ali Free Zone
Dubai
Phone: +971 4 8815 166
Telefax: +971 4 8815 136

United Kingdom

GRUNDFOS Pumps Ltd.
Grovebury Road
Leighton Buzzard/Beds. LU7 4TL
Phone: +44-1525-850000
Telefax: +44-1525-850011

U.S.A.

GRUNDFOS Pumps Corporation
17100 West 118th Terrace
Olathe, Kansas 66061
Phone: +1-913-227-3400
Telefax: +1-913-227-3500

Uzbekistan

Grundfos Tashkent, Uzbekistan The
Representative Office of Grundfos
Kazakhstan in Uzbekistan
38a, Oybek street, Tashkent
Телефон: (+998) 71 150 3290 / 71 150
3291
Факс: (+998) 71 150 3292

Addresses Revised 09.08.2017

be think innovate

95121197 1017

ECM: 1216378

The name Grundfos, the Grundfos logo, and **be think innovate** are registered trademarks owned by Grundfos Holding A/S or Grundfos A/S, Denmark. All rights reserved worldwide.
© Copyright Grundfos Holding A/S

www.grundfos.com

GRUNDFOS 