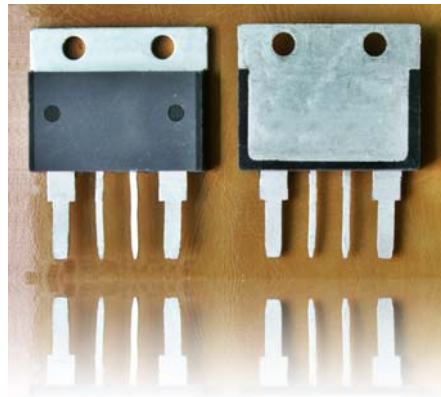

產品特性：NPNPN五層結構的硅雙向器件，具有自主知識產權的單面挖槽技術，檯面玻璃鈍化工藝；  
背面多層金屬化電極；具有較高有阻斷電壓、較高的溫度穩定性；大電流、絕緣型封裝。  
主要用於：加熱控制器、調溫設備、彩燈控制器、固態繼電器、吸塵器、電動工具、馬達調速控制器；其它相控電路。

Part Number	$I_{T(RMS)}$	$V_{RMD} / V_{RRM}$	$I_{GT}$	Package	
BTA100-600B	100A	600V	$\leq 50mA$	TOP4	
BTA100-800B		800V			
BTA100-1000B		1000V			
BTA100-1200B		1200V			
BTA100-1400B		1400V			
BTA100-1600B		1600V			
BTA100-1800B*		1800V*			

\* 未量产

■ PINNING: Insulated Package

Pin 管脚排列	Symbol 对应极性	Description 极性含义
1	T1	第一陽極
2		
3	G	門-控制極
4	T2	第二陽極
5	Tab	散熱片

TOP4 (TO-4PT or TO-228) 绝缘型封装

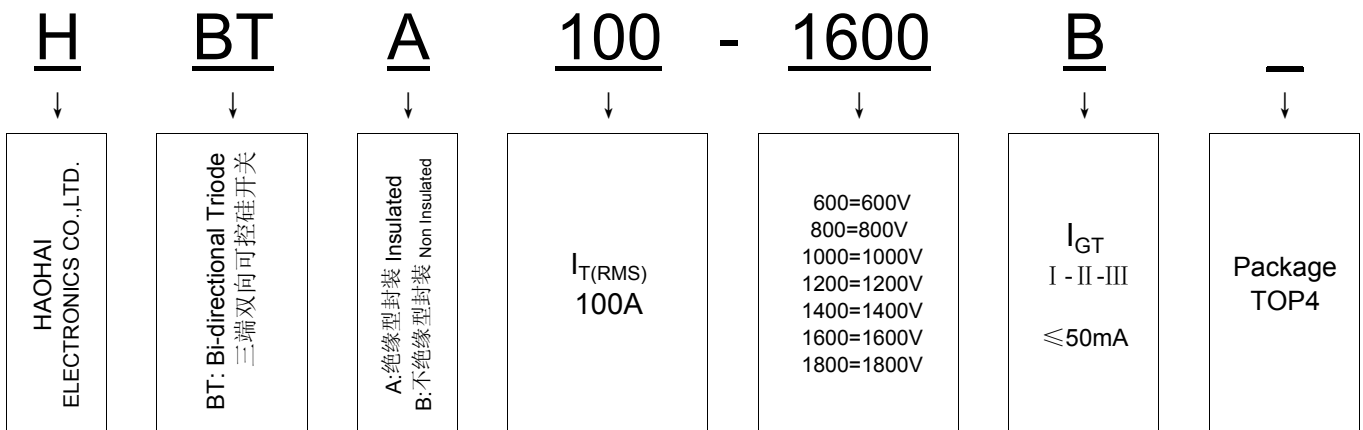
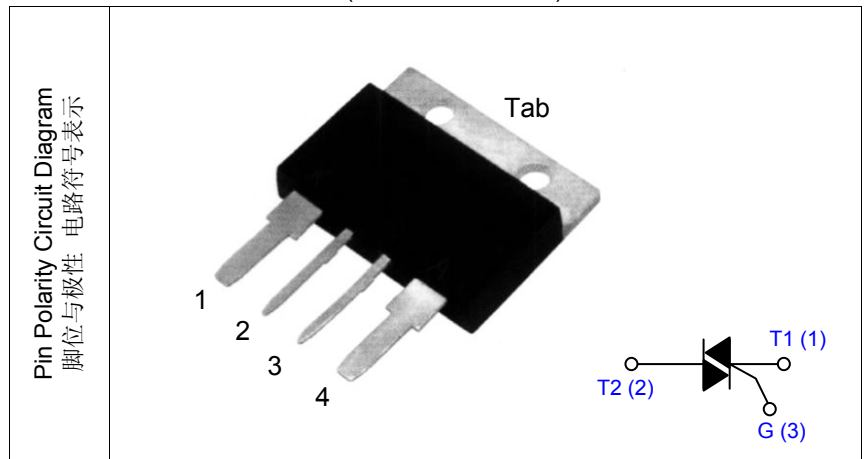

■ ABSOLUTE MAXIMUM RATINGS

SYMBOL	Signification in Symbol		Test Conditions	Value	Unit
$I_{T(RMS)}$	RMS On-state Current (full sine wave)		$T_C=80^\circ C$	100	A
$I_{TSM}$	Non Repetitive Surge Peak on-state Current		$T_J=25^\circ C, f=60Hz$	1000	
$I_{GM}$	Peak Gate Current		$tp=20\mu s, T_J=125^\circ C$	8	
$I^2t$	$I^2t$ Value for Fusing Consideration		$tp=10mS, T_J=25^\circ C$	6400	A <sup>2</sup> ses
$V_{DRM}$	Repetitive peak off-state Voltages	见型号对照列表	$T_J=25^\circ C$	600~1800	V
$V_{RRM}$	Repetitive peak Reverse Voltages	见型号对照列表	$T_J=25^\circ C$		
$P_{G(AV)}$	Average gate power dissipation		$T_J=25^\circ C$	1	W
$T_J$	Operating Junction Temperature Range			-40 ~ +125	°C
$T_{stg}$	Storage Junction Temperature Range			-40 ~ +150	
$R_{th(j-c)}$	Thermal Resistance-Junction-to-Case		TOP4	0.9	°C/W
$R_{th(j-a)}$	Thermal Resistance-Junction-to-Ambient			50	

■ 绝缘电阻特征: ISOLATION LIMITING VALUE & CHARACTERISTIC ( $T_{hs}=25^\circ C$  unless otherwise specified)

■ STATIC CHARACTERISTICS

SYMBOL	Parameter & Test Conditions	Quadrant	Value			Unit 单位
			Min	Typ	Max	
$I_{GT}$	$V_D=12V, R_L=30\Omega$	I (T2+G+)	--	25	50	mA
		II (T2+G-)	--	25	50	
		III(T2-G-)	--	26	50	
		IV(T2-G+)	--	50	100	
$I_H$	$I_T=500mA$	ALL	--	--	80	
$I_L$	$I_G=1.2 I_{GT}$	I, II, III	--	--	60	
		IV	--	--	100	
dV/dt	$V_D=2/3 V_{DRM}$ gate open	$T_J=125^\circ C$	500	--	--	V/ $\mu s$
(dv/dt)C	Without snubber	$T_J=125^\circ C$	10	--	--	
di/dt	Critical Rate of Rise of On-State Current	$T_J=125^\circ C$	--	50	--	A/ $\mu s$
$R_D$	Dynamic resistance slopes Resistance	$T_J=125^\circ C$	--	--	25	m $\Omega$
$V_{GT}$	$V_D=12V, R_L=30\Omega, T_J=25^\circ C$	ALL	--	--	1.5	V
$V_{GD}$	$V_D=12V_{DC}, R_L=30\Omega, T_J=25^\circ C$	ALL	--	--	0.2	
$V_{TO}$	$I_{TM}=82A, tp=380\mu s$	ALL	--	--	0.86	
$V_{TM}$	$I_{TM}=82A, tp=380\mu s$	$T_J=25^\circ C$	--	--	1.55	
$I_{DRM}$	$V_D=V_{DRM}, V_R=V_{RRM}$	$T_J=25^\circ C$	--	--	10	$\mu A$
$I_{RRM}$	$V_D=V_{DRM}, V_R=V_{RRM}$	$T_J=125^\circ C$	--	--	2	mA

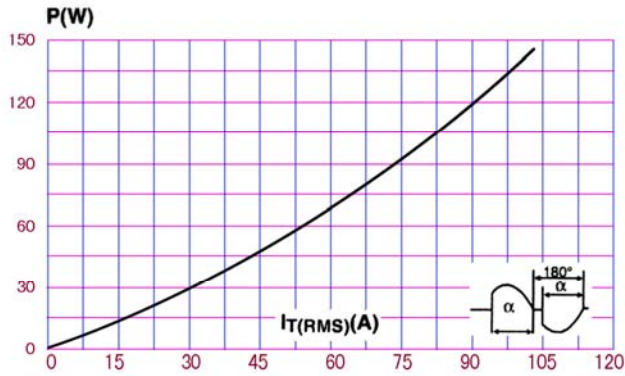

1、功耗与电流曲线 (180°)

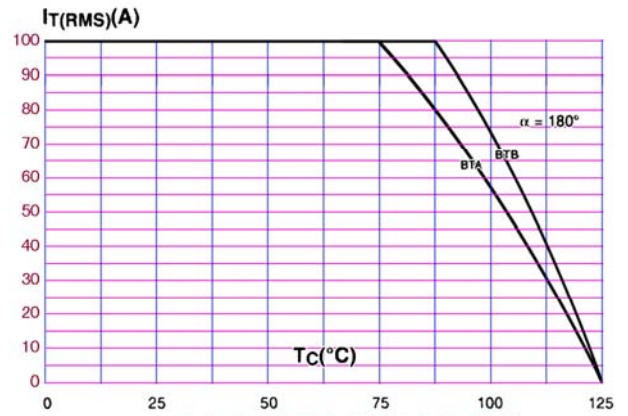

2、壳温与通态方均根电流曲线

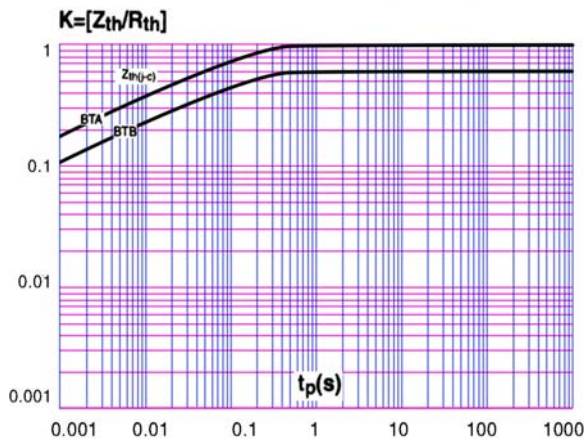

3、瞬态热阻曲线

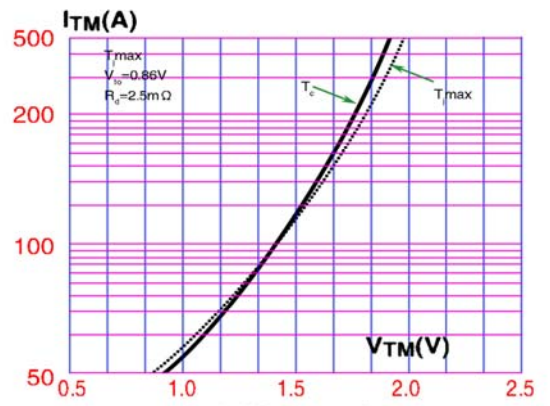

4、通态伏安特性曲线

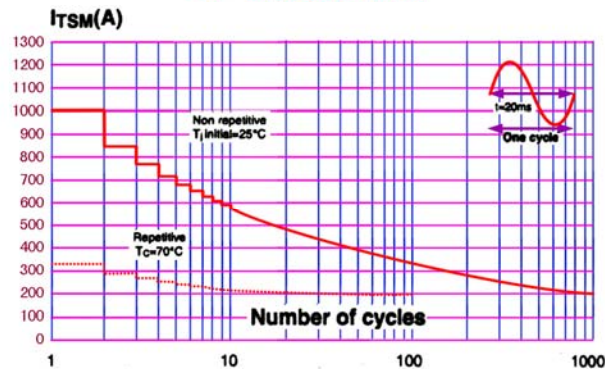

5、浪涌电流与周波数曲线

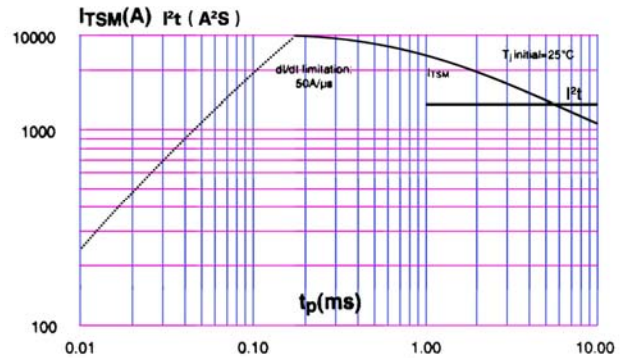

6、 $I_{TSM}-t, I_{pt}-t$  曲线

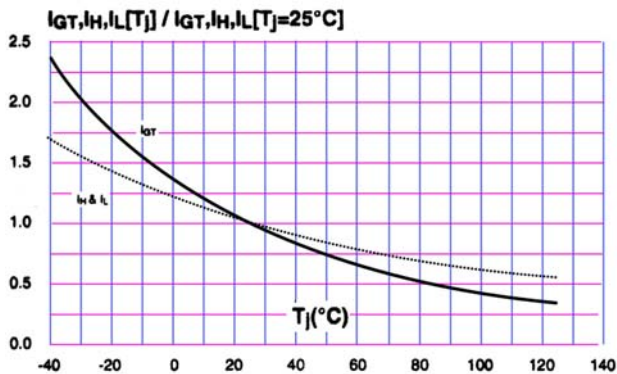

7、门极触发特性曲线

TOP4 PACKAGE MECHANICAL DATA (mm & inch)

TOP4 封装尺寸数据 (毫米与英寸对照)

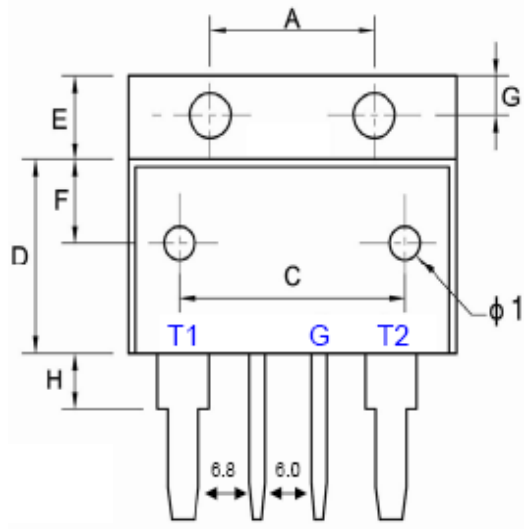
	正面		Dimensions			
			Millimeters		Inches	
			Min.	Max.	Min.	Max.
A	15.43	16.76	0.607	0.660		
B	31.05	32.15	1.222	1.266		
C	21.80	21.98	0.656	0.708		
D	16.65	17.98	0.656	0.708		
E	6.83	8.06	0.269	0.317		
F	6.80	8.05	0.268	0.317		
G	2.96	4.10	0.117	0.161		
H	4.65	5.36	0.183	0.211		
J	24.06	25.38	0.947	0.999		
K	14.16	15.36	0.557	0.605		
M	20.76	22.10	0.817	0.870		
N	1.65	2.98	0.065	0.117		
L	4.47	5.23	0.176	0.206		
Q	2.89	3.35	0.114	0.132		
P	1.14	1.56	0.045	0.061		
R	1.45	1.55	0.057	0.061		
Φ1	2.78	4.01	0.109	0.158		
Φ2	3.95	5.19	0.158	0.204		

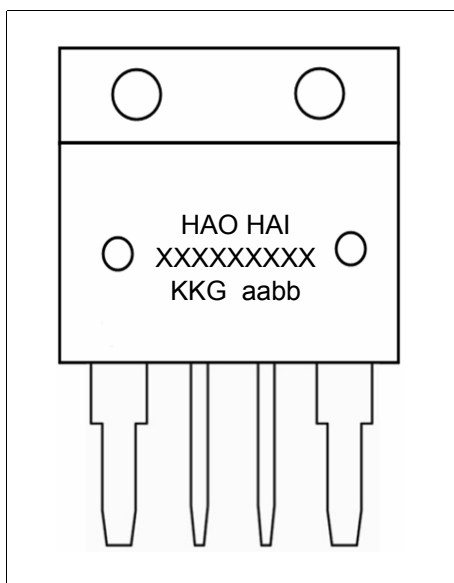

打印标识

HAOHAI: 浩海电子  
XXXXXXXXXX: 器件型号  
KKG: 注册商标  
aa: 出厂年份  
bb: 出厂自然周 (01~53)

Marking

HAOHAI ELECTRONICS  
XXXXXXXXXX: Part Number  
KKG: Registered trademark  
aa: Factory Year  
bb: Factory natural Week  
(01~53)

包装规格

TOP4  
条管装、纸盒装  
每管15只  
每盒300只

Packaging Specifications

TOP4  
Plastic tube  
15Pcs/Tub  
300cs/BOX

Manufacturers version information

2006-09-01, KKG™ Product Data-1.1  
2019-04-25, KKG™ Product Data-1.2  
2011-06-10, KKG™ Product Data-1.3  
2015-12-10, KKG™ Product Data-1.4



经中华人民共和国工商行政管理总局商标局批准  
KKG 图案、字母、均为我公司正式注册商标，仿冒、盗用均属侵权，违法必究！  
WARN, Letters, patterns, are officially registered my trademark counterfeiting, theft are all violations, violators will be held liable !

## 深圳市浩海电子有限公司

SHENZHEN HAOHAI ELECTRONICS CO., LTD.

2 floor(whole floor), BAOXIN Building. 0 Lane on the 8th. Yufeng Garden.  
82 District. BAOAN District, Shenzhen City, Guangdong Province, China.

公司电话 TEL: +86-755-29955080、29955081、29955082、29955083  
总机八线 29955090、29955091、29955092、29955093

FAX: +86-755-27801767  
产品主页: <http://www.szhhe.com>

E-mail: [kkg@kkg.com.cn](mailto:kkg@kkg.com.cn)  
<http://www.kkg.com.cn>