

MODELS:

ENGLISH

EN

1 or 2 channel digital time switches - daily, weekly, monthly/yearly - input/s for external control - slot for an external memory key

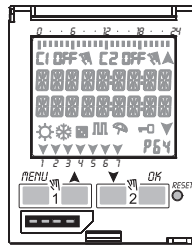
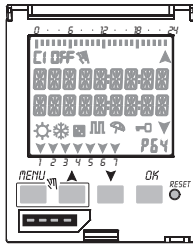
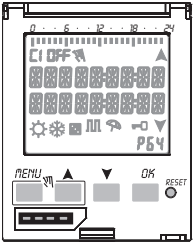

external memory key
(sold separately)

1 or 2 channel digital time switches - weekly, monthly/yearly - input for synchronisation with DCF77 or GPS antenna - slot for an external memory key

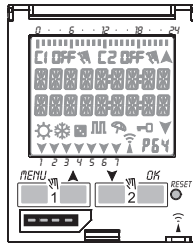
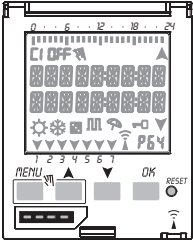

external memory key
(included in the package)

DISPLAY

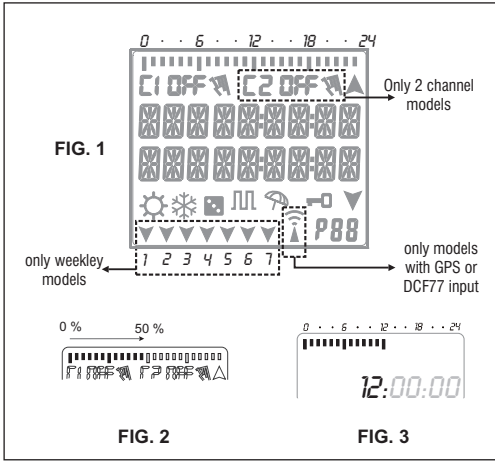

KEYS

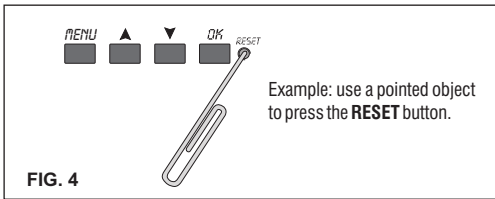

ELECTRICAL CONNECTIONS

EN

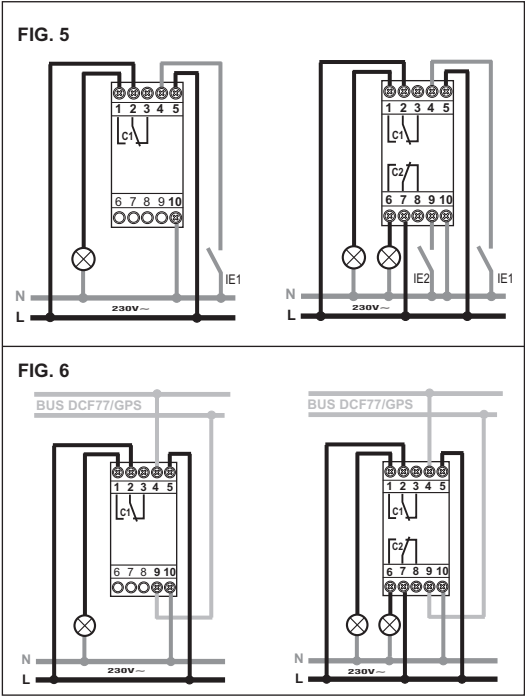



Contents

Description of equipment	pag.18	3 Clock programs and settings	pag.24
1-1 Operational features	pag.18	3-1 Standard Program	pag.24
1-2 Technical features	pag.19	3-2 Random Program	pag.24
1-3 Display (Fig. 1)	pag.19	3-3 Cyclic Program	pag.24
1-4 Function keys	pag.20	3-4 Holidays Program	pag.24
1-5 Combined key functions	pag.20	3-5 PGR List (programs)	pag.25
1-6 Connections	pag.20	3-6 Delete	pag.25
1-7 First switch ON	pag.20	3-7 Manual	pag.25
2 Menus and programming	pag.21	3-8 Options	pag.26
2-1 Menus - overview	pag.21	3-8-1 Languages	pag.26
2-2 Forcing priority and programs	pag.21	3-8-2 Date/Time	pag.26
2-3 Create a new program	pag.22	3-8-3 External input	pag.28
2-4 Check a program	pag.23	3-8-4 Maintenance	pag.28
2-5 Modify a program	pag.23	3-8-5 Hour meter	pag.29
2-6 Delete a program (Fast method)	pag.23	3-8-6 Back-lighting	pag.29
2-7 Copy a program	pag.23	3-8-7 Warranty	pag.29
		4 External Memory Device (EMD)	pag.29

1 Device description (based on the mode)

the digital time switch is a clock which is programmable daily or weekly, with the possibility to insert yearly programming, which allows automatic switching of different loads (single or dual channel) based on time programming which is flexible enough to provide for or exclude activation (ideal use in residential buildings, industry, schools, offices, public places, etc.) and is also equipped with input/s for remote activation. For versions with a slot for an EMD key (External Memory Device), it is possible to save/copy or read one or more programs on different time switches of the same model by means of a special memory key. Models which can be connected with time signal receivers: DCF77 or GPS types allow optimised precision time synchronisation.

Safety

-  - Carefully read this manual before assembling the product and putting it into operation.
-  - This equipment must be assembled and connected solely by adequately skilled personnel.

18

1-1 Functional characteristics (based on the model)

- Models with daily, weekly monthly/annual programming, menu driven guided with indications on backlit display
- Models with one or more relay control outputs
- Intelligent relay command that increases the load values and life time of both the relay and the connected load "zero crossing"
- Models with external input/s for manual remote forcing output/s
- Models with an external memory key to execute and memorise programs with possibility of downloading / uploading only holiday programs
- Calendar: year - month - day - hour and minutes
- Multilanguage menu: Italian - English - German - French - Spanish - Portuguese - Swedish - Dutch - Russian - Polish - Greek
- Type of programs: Standard, Random, Cyclic, Holiday
- 64 settable programs
- Holiday: different periods throughout the year can be set
- Minimum programming ON/OFF time of 1 second
- Quick deleting of programs
- Simplified permanent or temporary manual ON/OFF mode
- Date/hour setting with summer/winter automatic time change
- Hour counting for monitoring the working time of the connected loads
- Maintenance programming of the connected loads
- Managing of the warranty period
- Keyboard blocking
- White backlit display
- Backlit display management: fixed ON / fixed OFF / temporized switching OFF
- Ecologic Lithium battery (not removable) with 6 years lifetime
- Permanent memory for memorizing programs
- High precision quartz mechanism: $\leq \pm 0.5$ sec/day
- Models which can be connected to time signal receivers: DCF77 or GPS.

Note: back panel mounting is possible on all items with optional accessories







The equipment contains a non-removable battery and it must not be disposed of as urban waste but recycled in order to protect the environment. Failure to comply with the requirements of EU Directive 2006/66, and the national legislations for implementation of this Directive, for the disposal of products at the end of their service life, is punishable by law.















1-2 Technical features

Power supply voltage	230 V a.c. +/- 10%
Frequency	50-60 Hz
Protection rating	IP20
Output type	Potential-free relay with changeover contact; N.O. Contact = 16(10)A / 250V~ (limited current with Resistance for Zero Crossing of high value); N.C. contact = 16(2)A / 250V~
Cross-section of cables at terminals	1...6mm ²
Backup in case of power failure	6 years from first switch on, guaranteed by lithium battery
Nominal pulse voltage	4kV
Software	Class A
Time tolerance	+/- 0.5 sec/day at 25°C
Absorption/Self-consumption	6.5 VA single channel / 7.8 VA twin channel
Insulation class	Class II
Pollution rating	Normal
Installation	DIN- back panel (with optional KIT)
Operating temperature	From 0 °C to +50 °C
Storage temperature	from -10°C to +65°C
CE standards	LVD/EMC EN60730-2-7
Languages available in menu	Italian, English, German, French, Spanish, Swedish, Portuguese, Dutch, Russian, Polish, Greek



Maximum pilotable power

				
3000W	3000W	1100W	900W (125 µF)	7W ÷ 23W (max. 23 lamps)

1-3 Display (see Fig. 1 on page 17)

	Channel 1/Channel 2		OFF/ Channel deactivated
	Manual forcing of channel		ON / Channel active
	Standard Time (summer)		Daylight Saving Time (winter)
	Random programs		Cyclic programs
	Holidays icon		Keyboard lock
	GPS or DCF77 signal reception indication		Scroll up
	Program no. Selected P01-P64		Scroll down

EN

-  The striped bar on the display also shows:
 - Progress status, see Fig.2 on page 17 (e.g. cancelling see chapt. 3-6).
 - Hour display, see Fig.3 on page 17.
-  The display shows alternately (for a few seconds) the date and the time and the programs or forcings set.

1-4 Function keys

	<ul style="list-style-type: none"> Enter main menu (from initial screen). Exit from any setting
	<ul style="list-style-type: none"> Scroll list upwards. Increase a numerical value or change a parameter. Hold down to display status of channel 1 until button is released (under normal operation).
	<ul style="list-style-type: none"> Scroll list downwards. Decrease a numerical value or change a parameter. Hold down to display status of channel 2 (twin channel models) until button is released (under normal operation).
	<ul style="list-style-type: none"> Confirm proposed setting.
	<ul style="list-style-type: none"> Reset equipment (NOTE: The programs and external input settings are not deleted).

Note: Reset resets the time switch and is used at first programming, or should displays of abnormalities or malfunctions be displayed. Press the Reset button with a pointed object. After a brief display test, all display segments will be lit and then screen showing the choice of language will be displayed. The following are lost upon Reset: keyboard blocking, current date and time settings, these will have to be re-programmed. The time switch will not function until you re-program it. Set programs, external input ON/OFF and data relative to maintenance, operating hours and warranty counts are not lost.

1-5 Combined key functions

It is necessary to be on the initial screen to carry out any of the functions (see table)

Function	Combined keys
Lock / unlock keys (←→).	2 secs.
Temporary manual forcing of channel 1 and 2 (ref. subsection 3-7). Alternate pressure to change it from TEMP ON to TEMP OFF.	

Function	Combined keys
Permanent manual forcing of channel 1 and 2 (ref. subsection 3-7). Press for 2 secs. to access PERM alternate pressure to change it from PERM ON to PERM OFF.	2 secs. 2 secs.
Return to AUTO mode (if any manual forcing has been activated).	2 secs. 2 secs.

1-6 Connections (disconnect the 230V~ mains voltage)

i Maximum cable distance for switch or button connection to external input (E.I.) of the clock: 100 m (Fig. 5 on page 17).

Connection of single channel and twin channel models

• See diagram Fig. 5 on page 17

Connecting models with input for DCF77 or GPS

Single channel or twin channel Synchro models with GPS or DCF77 Antenna.

• See diagram Fig. 6 on page 17

1-7 First switch ON

The equipment is supplied without any settings.

1. Press **RESET** with a pointed object to unlock the equipment .

2. Set following data:

• **Languages** (Ref. subsection 3-8-1).

• **Date/Time** (Year, Month, Day, Time, Time Zone - ref. subsection 3-8-2).

i If there is a power failure, the Date/Time is memorised, and the digital switch:

- disables relay(s).
- deactivates back-lighting, if active,
- displays flashing date and time for 2 minutes, and then changes to stand-by mode (display switched OFF) storing all the programmed data, until the mains power supply is reconnected or until a button which restarts the counter for the stand-by mode is pressed for more than 1 sec.



2 Menus and programming

2-1 Menus - overview

The menus listed from 1 to 8 are in the sequence present in the equipment.

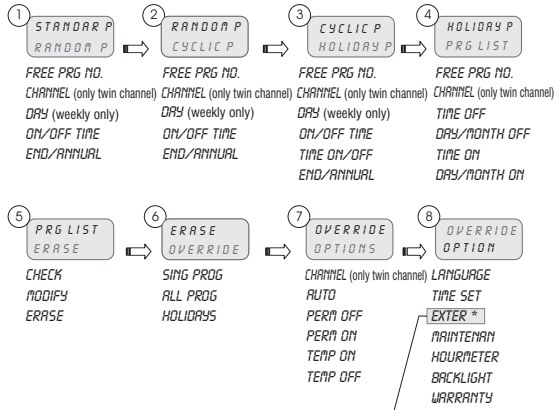

* Not including models synchronizable with DCF77 or GPS

Procedure to select the desired menu:

1. Press **MENU**.
 » The first menu which may be selected appears (P Standard)
2. Scroll the various menus using keys **▲▼**.
3. Confirm desired menu with **OK**.

2-2 Forcing priority and programs

- 1 A priority is assigned to every type of program, as shown alongside.
- 1 Take the priorities into consideration when various types of programs are programmed for the same period of time.

Example:

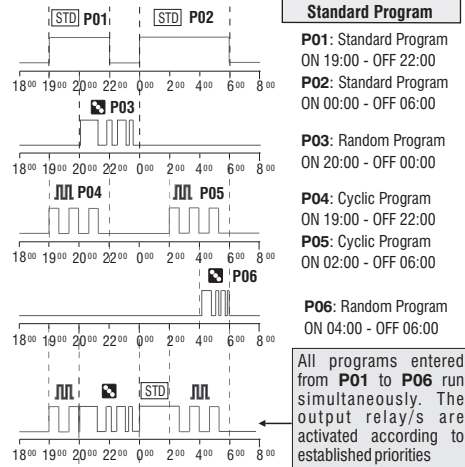

2-3 Create a new program

i Procedure valid for all types of programs. Further settings are described in the individual programs.

EN

Selection of program type (e.g. with P Standard):



1. Press **MENU**.
2. Select program type using keys **▲▼**.
3. Press **OK** to confirm selection.
 - » The number of free programs appears for 3 secs.
 - » The first program in the memory appears.
4. Press **▼** for 2 secs.
 - » The display shows the first empty program.
5. Press **OK** to confirm.



- » The program number is selected.
- » Followed by channel setting. (only for dual channel models)

Select channel (only 2 channels models)



1. Set channel (twin channel) using keys **▲▼**.
 - » C1/C2 or both flash.
2. Press **OK** to confirm.
 - » The program number is selected.
 - » Followed by channel setting. (only for weekly models)

Set day (only for weekly models)

Select the day or group of days in which the program must be executed.



1. Set the day or group of days using keys **▲▼**.
 - » The flashing arrow indicates the day or group of days selected.
2. Press **OK** to confirm.
 - » Followed by TIME/ON setting.

1 2 3 4 5 6 7

only for weekly models: if a group of days is selected (eg Saturday and Sunday) and a time frame that extends past midnight (eg ON = 23:30 hours, time OFF = 2:00), the program runs two times, but the second run ends on Monday. In this case, the Monday icon flashes as a warning. This same principle applies to programs lasting longer than a day.

Set TIME/ON



1. Set program start time using keys **▲▼** in the format **hh/mm**.

- i** Single pressure of keys moves field by minutes. Prolonged pressure of keys moves field by hours.
2. Press **OK** to confirm.
 - » The seconds field appears.
 3. Set the seconds using keys **▲▼**.
 4. Press **OK** to confirm.
 - » The program start time has been set.
 - » Followed by TIME/OFF setting.

Set TIME/OFF



1. Set program end time using keys **▲▼**.

i Repeat operations as per TIME/ON.
2. Press **OK** to confirm.
 - » The program end time has been set.
3. Press **OK** to confirm program end time.
4. Enter a new program or exit press the **MENU** button several times

Note: if you enter zero in the seconds fields for ON and OFF, the seconds field is not shown in the data summary.

Programs must also have a minimum duration of one second, so the OFF time cannot be the same as the ON time. (Programs like this are not accepted.)

Only for weekly models: set the OFF hour scrolling the time forward with respect to the ON hour. Scroll back to select the whole week

Creating a program with a duration of several days

(Only weekly mod.)

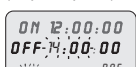

The duration of a program can be extended to several days (eg, begins Monday at 12:00 and ends Wednesday at 14:00). Just scroll past 24 hours when setting "TIME OFF". Scrolling past 24 hours is confirmed when the day after the start of the program blinks. At every passage from 24 hours, the program will be further extended to the next day.

Set ANNUAL PERIOD

Enables a defined period to be set, in which the program set up previously must be executed.

i The period defined in the annual program is repeated cyclically every year.



1. Set the start and end of the period in the format **dd/mm/-** using keys **▲▼**.
2. Press **OK** to confirm every field.
 - » The annual period is set.
3. Enter a new program or exit press the **MENU** button several times



Note: P YEARLY can be set over the end of a year, eg Month ON OCTOBER and Month OFF March (the program will last a total 5 months where the month OFF will stop in the following year, and so forth cyclically).

2-4 Check a program

Access desired program menus (STANDARD P, CYCLIC P...) by pressing **MENU**.



1. Select the program type from the menu (e.g. RANDOM P) using keys **▲▼**.
2. Press **OK** to confirm.
 - » The programs of the same type in the memory are displayed.
3. Select the program to be checked using keys **▲▼**.
 - » The display shows the settings cyclically.



2-5 Modify a program

1. Press **OK** to confirm program to be modified.
2. Set new values as described in subsection 2-3.

2-6 Delete a program (fast method)



1. Select from the menu the program type to be deleted using keys **▲▼**.
 - » e.g. RANDOM P
2. Press keys **▲▼** simultaneously for 2 secs.
 - » The display shows "ERASE".
3. Press **OK** to confirm.
 - » The display shows "EMPTY".
The program is deleted.



2-7 Copy a program

1. Select from the menu the program type to be copied (e.g. RANDOM P) using keys **▲▼**.
 - » The program number flashes.
2. Press **OK** for approx. 3 seconds
 - » The program is copied in the first free position in the memory.
 - » The first modifiable data (eg: channel) is displayed flashing.
3. Modify data as described in subsection 2-3.

i 2 programs with the same data cannot coexist!

Note: if no changes are made within 10 minutes or if **MENU** is pressed several times, the device will return to start display and the new duplicated program will be lost.

3 Clock programs and settings

1. Press **MENU** to access available menus.
2. Scroll menus using keys **▲▼** and press **OK** to confirm.

3-1 Standard Program

Allows switching on (ON) and switching off (OFF) of a load in the defined period

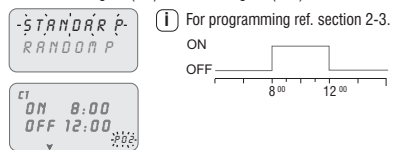

Example of set up from image:
Standard Program ON 8:00 - OFF 12:00.

3-2 Random Program

Allows switching on (ON) and switching off (OFF) of a load in random mode within a defined period

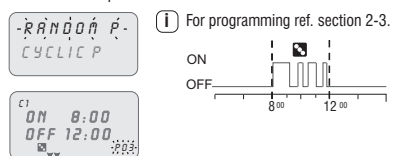

Example of set up from image:
Random Program ON 8:00 - OFF 12:00.

When the random program is on, the symbol  will blink on the main display.

3-3 Cyclic Program

Allows switching on and switching off of a load in cyclic mode (time ON/OFF) within a defined period

1. The ON time and the OFF time may vary from 1 sec. up to 23:59:59 hours
2. For programming ref. section 2-3.
3. In addition, set the time of TIME ON and TIME OFF using keys **▲▼**.

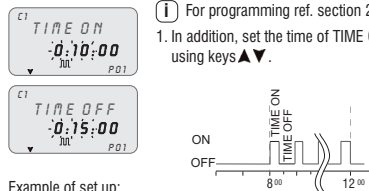

Example of set up:

Cyclic Program ON 8:00 - OFF 12:00.
Timing of TIME ON 10 min and TIME OFF 15 min.

When the random program is on, the symbol  will blink on the main display.

3-4 Holidays Program

The holiday programs let you set different periods throughout the year for the suspension of programs on/off combined with channel 1 and/or 2 (dual channel mode), eg summer holidays and Christmas in a public or sales office.

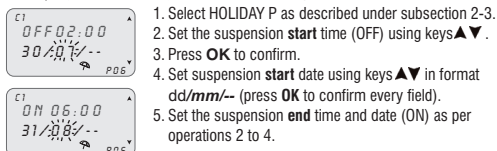

During the set holiday period, the number of the affected channel, a HOLIDAY message and the symbol  will appear on the operating screen.

The outputs (C1 and/or C2) are OFF.

To cancel the suspension period, use the special function in the CANCEL menu (see par. 3.6).

3-5 PRG List (programs)

This menu enables any program in the memory to be displayed, modified or deleted.



1. Scroll to "PRG LIST" using keys ▲▼.
2. Press **OK** to confirm.
 - » The number of free programs appears.
 - » The first program in the memory is displayed.
3. Select the desired program using keys ▲▼.



- i** Ref. subsections 2-4 to 2-6 for details on checking, modifying or deleting data.



3-6 Delete

This menu enables different type of deletions to be made.



1. Scroll to ERASE using keys ▲▼.
2. Press **OK** to confirm.
 - » The type of deletion in the sub-menu is accessed (ref. table below).
 - » Select deletion type using keys ▲▼.
3. Press **OK** to confirm deletion.

- i** Press **MENU** to cancel deletion.

Sub-menu	Function
SING PRG	Delete single programs selected
ALL PRG	Delete all programs <i>All programs in the memory will be deleted!</i>
HOLIDAY P	Delete all holiday programs

3-7 Manual

This enables the status of the outputs to be forced manually regardless of active program. Possible settings:

Forcing Mode	Display Symbol	Channel-Condition	Forcing function
AUTO		C1 C2	No forcing on channel; management from program.
PERM		C1 On C2 On	Permanent channel activated.
PERM		C1 OFF C2 OFF	Permanent channel de-activated.
TEMP		C1 On C2 On	Channel activated until next program activity.
TEMP		C1 OFF C2 OFF	Channel de-activated until next program activity.

EN

Activate a forcing

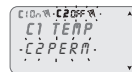
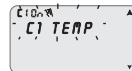

1. Select sub-menu "OVERRIDE" using keys ▲▼.
2. Press **OK** to confirm.
3. Press combined keys (ref. subsection 1-5) to select channel (only twin channel models).
 - » The display shows information on channel(s) (Ref. table above).
4. Set type of forcing using keys ▲▼.
5. Press **OK** to confirm selection.
 - » It returns to the main screen.
 - » The display shows the type of forcing on the channel.

De-activate a forcing (from the main screen)

1. Press combined keys of the channel to be de-activated (ref. subsection 1-5) for approx. 2 secs.

- i** Select "AUTO" mode to deactivate using the menu (ref. subsection "Activate a forcing").

3-8 Options

This enables various clock parameters to be set.

EN



1. Select "OPTIONS" using keys ▲▼.
2. Press **OK** to confirm.
 - » The sub-menus follow.

3-8-1 Languages

This enables the desired interface language to be set.



1. Select the "LANGUAGE" sub-menu using keys ▲▼.
2. Press **OK** to confirm.
3. Select the desired language using keys ▲▼.
4. Press **OK** to confirm.



3-8-2 Date/Time (current)

This enables the date and time of the equipment to be set. the type of Standard Time/Daylight Saving time change; GPS or DCF77 settings (only for models with this option).

i If the equipment is reset the date must be set again.



1. Select "TIME SET" using keys ▲▼.
2. Press **OK** to confirm.
3. Set YEAR, MONTH, DAY, HOUR, MINUTES, respectively, using keys ▲▼.
 - i** Single pressure of keys moves field by minutes. Prolonged pressure of keys moves field by hours
4. Press **OK** to confirm.
 - » Date and time are set.
 - » Followed by "SUM/WIN" setting. or GPS or DCF77 settings (only for models with this option).

Winter (☀) / Summer (☀) time change



1. Select switching type using keys ▲▼.
2. Press **OK** to confirm.
3. Set values (ref. table) using keys ▲▼.
4. Confirm each selection pressing **OK**.

Possible selections on display	Summer switching +1h (☀ standard time)	Winter switching -1h (☀ daylight savings time)
NONE	None	None
EUROPE (default setting)	Last Sunday in March	Last Sunday in October
USA	Second Sunday in March	First Sunday in November
FREE TZ	Week/day (Sun.) freely programmed	Week/day (Sun.) Freely programmed
FIXED TZ	Fixed date freely programmed (e.g. 28/02)	Fixed date freely programmed (e.g. 29/10)

Time Zone GPS (only GPS and DCF77 models)

Set the correct time zone (TZONE)

with respect to Greenwich position:

- add if you are east of Greenwich time

- subtract from the Greenwich position if you are west of Greenwich time

(e.g. Italy, T ZONE +1).



i After setting TIME SET (ref. subsection 3-8-2).

1. Select "GPS" using keys ▲▼.
2. Press **OK** to confirm.
3. Select the SUM/WIN mode (ref. previous table).
4. Set number of T ZONE hours using keys ▲▼. Adjustable parameter -12 ÷ +12
5. Press **OK** to confirm.
 - » The time change has been set.
 - » It returns to the main screen.

Time Zone DCF77 (only models with GPS and DCF77 input)

As opposed to the GPS, the receiver transmits the time difference with the Summer/Winter correction.

Set time zone correction (TZONE) with respect to Frankfurt position:

- add if you are east of Frankfurt
- subtract if you are west of Frankfurt (eg. Italy, TZONE +0).



i After DATE/HOUR setting (see chapt. 3-8-2).

1. Select "DCF77" with the buttons ▲▼.
2. Confirm with **OK**.
3. Set the T ZONE hour number with the buttons ▲▼.
Adjustable parameter -3 ÷ +3
4. Confirm with **OK**.
 - » The time change has been set.
 - » You will now return to the main screen.



OPERATION MODE WITH GPS or DCF 77 RECEIVER

If the product is connected to a GPS or DCF 77 receiver for time synchronization, the operation symbol  with the following signals will appear on the display (once programming has been implemented):

EN

	BLINKING = waiting for synchronization, no synchronization (after 24 hours of waiting)
	CONSTANTLY LIT = synchronization present
	ABSENT = no signal or receiver disconnected

Sample table of time zone differences

Difference with respect to Greenwich time	Difference with respect to Frankfurt time
+1 h	0 h
+2 h	+1 h
+3 h	+2 h
0 h	-1 h
-1 h	-2 h

3-8-3 External input

This enables manual ON and OFF forcing functions to be executed from a remote position, (ref. section 3.7), by means of buttons or switches.

- EN** **i** Function not available for the SYNCHRO models from GPS or DCF77 input (the "EXT INPUT" item is not available in the "OPTIONS" menu).



1. Select the "EXT INPUT" sub-menu using keys ▲▼.
2. Press **OK** to confirm.
3. Select the channel with the keys ▲▼. (dual channel mod.).
4. Confirm with **OK**.
5. Select switching type (ref. table below) using keys ▲▼.
6. Press **OK** to confirm.

- i** In order to deactivate settings made, repeat actions from 1 to 4.
 • Press **OK** to confirm "DEACTIVAT" selection.

Display Selection	Channel C1 or C2 (twin channel)	Symbol	Function	External control
PERM	ON OFF		Permanent forcing of channel ON or OFF.	 Switch
TEMP			Temporary forcing of the channel until the next switching of a program set previously.	 Button
TIMER	ON OFF		Forcing of a timed channel (e.g. stairway lighting Control). *Time may be set in format Hh:mm:ss.	 Button

*Set the time as per previous procedure, entering On and Off.

Note: closing of the external input contact is detected immediately by the clock, while opening can take max 1 sec.

3-8-4 Maintenance

Allows setting of an operating period in ON for channel C1 and/or C2 (dual channel mod.). After this period, the clock signals the need for an operation with the writing "C1 MAINT" or "C2 MAINT", alternating with the current date.

This information can be used to perform maintenance at predetermined intervals of time on the connected output device.



1. Select the "MAINTENAN" sub-menu using keys ▲▼.
» C1 flashes.
2. Select channel using keys ▲▼ (twin channel models).
3. Press **OK** to confirm.
4. Set number of hours using keys ▲▼.



- i** Keep the arrow key pressed to rapidly increase/decrease the tens, hundreds, etc. Repeated pressing moves the unit forward one at a time.
5. Press **OK** to move on to the next channel (dual channel only) or press **MENU** to exit.

- i** In order to modify or reset the values, follow Instructions from 1 to 5.

Note: if you modify the maintenance count setting, you will lose any partial count that may have already accumulated.

Cancel maintenance notice

At the end of the countdown, the MAINTENAN message flashes on the active screen. You can cancel the message once you have completed the necessary maintenance by pressing **OK**, pressing and holding for about 2 seconds during the active channel warning.

Attention: when you cancel the MAINTENAN message, the maintenance hour count restarts automatically.

- i** Set the counter to zero for the channel and/or channels to disable the MAINTENANCE hour count.

3-8-5 Hour meter

This function counts the total number of hours for which the output is active (ON). Its purpose is solely to monitor the working life of the device connected to the channel and/or channels (dual channel mod.).



1. Select the "HOURMETER" sub-menu using keys ▲▼.
2. Press **OK** to confirm.
3. Select channel using keys ▲▼.
 - » The display shows the hours of operation.



- 1. Press keys ▲+▼ to zero.
4. Confirm with **OK** and exit from settings.

3-8-6 Back-lighting

This enables the display backlighting time to be set.



1. Select the "BACKLIGHT" sub-menu using keys ▲▼.
2. Press **OK** to confirm.
3. Select using keys ▲▼ between: FIXED ON, FIXED OFF or TEMP 6 SEC.



4. Press **OK** to confirm and exit from settings.

3-8-7 Warranty

This enables the time since the putting into service of the clock to be displayed in days.



1. Select the "WARRANTY" sub-menu using keys ▲▼.
2. Press **OK** to confirm.
 - » The display shows the time, as described above.



- 1. Counter may not be zeroed.
3. Confirm with **OK** and exit from settings.

4 External Memory Device (EMD)

The EMD is an external memory card, which is able to manage 64 programs, including the holidays.

i The EMD is the programming key.



1. Insert the EMD.
 - » The display shows the memory management menu.
2. Select the desired sub-menu (ref. table) using keys ▲▼.
3. Press **OK** to confirm every selection.

Sub-menu	Function	Notes
EXECUTE	Execute programs directly from EMD	The programs are executed only from EMD
SAVE>EMD	Save all clock memory on EMD	Overwrite all programs already present on EMD
LOAD<EMD	Load all content from EMD on clock memory	Overwrite all programs present on clock
READ	Read programs from EMD	Display only the programs present on EMD
HOLID>EMD	Load Holiday programs from clock to EMD	Overwrite all Holiday programs present on EMD
HOLID<EMD	Load Holiday programs from EMD to clock	Overwrite all Holiday programs present on clock
ERASE	Delete programs present on EMD	Permanently delete all EMD Memory



1. Press **MENU** to exit.
2. Press **OK** to confirm "ABORT" selection.
 - » The EMD is excluded from the clock.
 - » The EMD memory is no longer recognised.
3. Withdraw the EMD.

Attention: the memory key can be used to share data, only with same model devices. Otherwise, the display will show an error message.

The manufacturer reserves the right to introduce any technical and/or constructive changes deemed necessary, with no prior notice.