

**SLID'UP**  
by MANTION

INSTRUCTION DE MONTAGE  
MONTAGEANLEITUNG  
INSTRUCTIONS FOR ASSEMBLY  
INSTRUCCIONES DE MONTAJE  
INSTRUKCJA MONTAŻU

**SLID'UP 140**  
SU5120

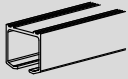

x1

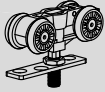

x1

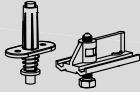

x1

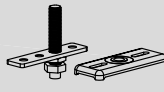

x1



x3



25  
KG

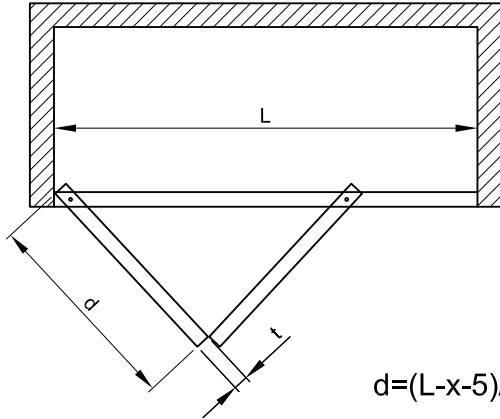

$$d = (L - x - 5) / 2$$

t [mm]	<22	22,25	28,32	40
x [mm]	0	3	4	6

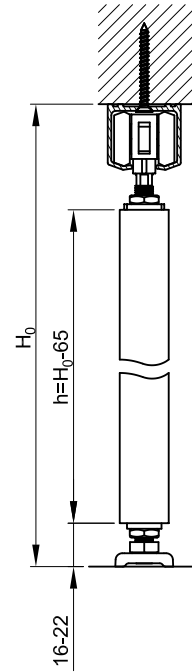

1

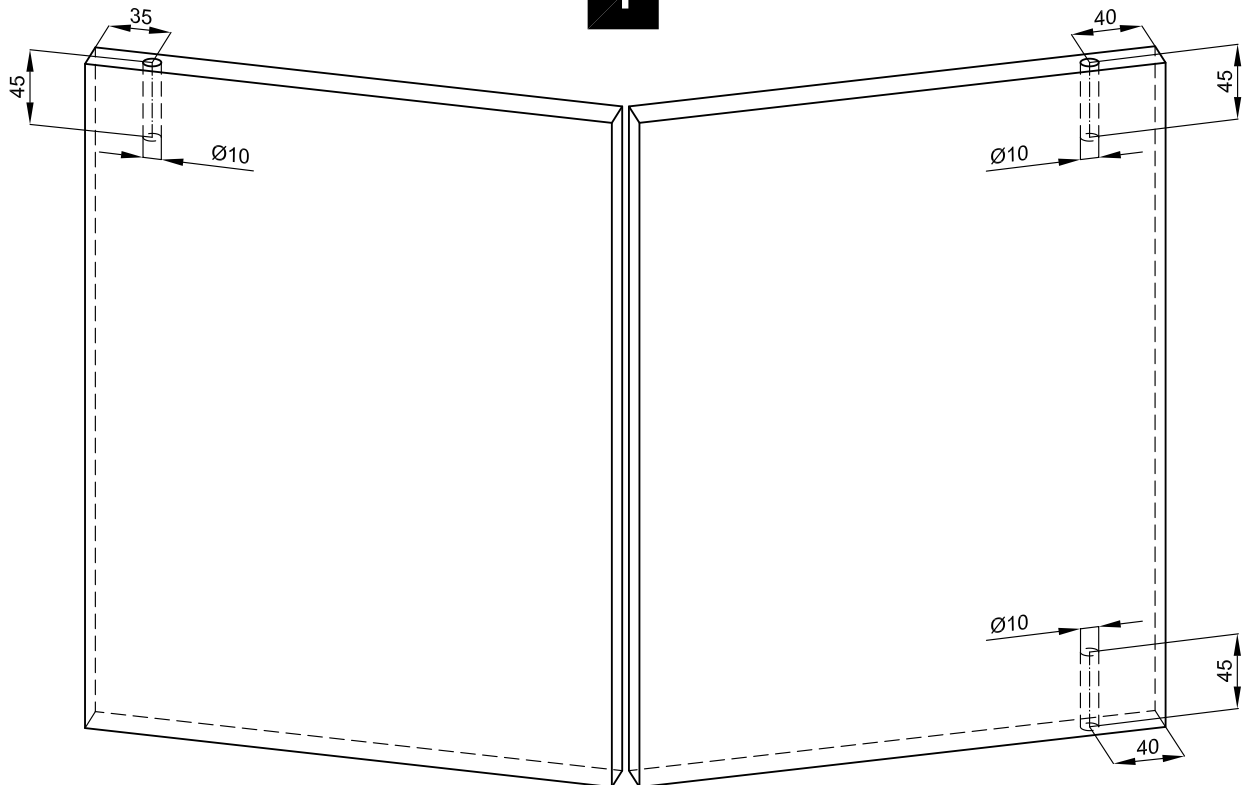

2

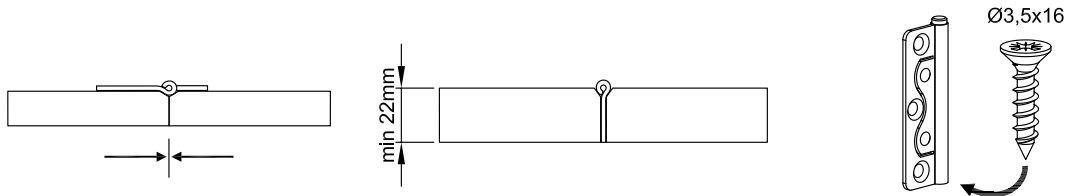

3

