

F notice d'instruction

CIRCUIT IMPRIME

GB user instructions

PRINTED CIRCUIT BOARD

I istruzioni d'impiego

CIRCUITO STAMPATO

ES manual de instrucciones

CIRCUITO ELECTRÓNICO

Silencer Grey
Silencieux Gris
Silenziatore Grigio
Silencioso Gris

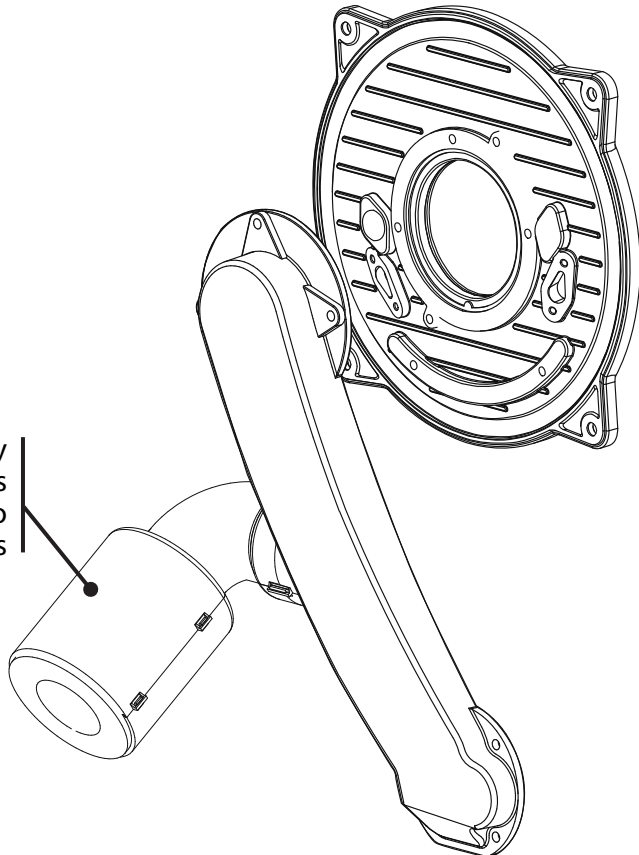

F notice d'instruction

ATTENTION

CONSERVER L'EEPROM DU NOUVEAU CIRCUIT
sauf pour les appareils suivants :

3665092 E-COMBI 24 FF (GB)
3300355 E-COMBI 24 NG (GB)
3300353 E-SYSTEM 24 NG (GB)
▶ Utiliser l'EEPROM "24 kW"

3665093 E-COMBI 30 FF (GB)
3300354 E-SYSTEM 30 NG (GB)
▶ Utiliser l'EEPROM "30 kW"

3665094 E-COMBI 38 FF (GB)
▶ Utiliser l'EEPROM "38 kW"

GB user instructions

WARNING

USE EEPROM SUPPLIED ON THE NEW PCB
except for the following devices:

3665092 E-COMBI 24 FF (GB)
3300355 E-COMBI 24 NG (GB)
3300353 E-SYSTEM 24 NG (GB)
▶ Assemble the EEPROM marked "24 kW"

3665093 E-COMBI 30 FF (GB)
3300354 E-SYSTEM 30 NG (GB)
▶ Assemble the EEPROM marked "30 kW"

3665094 E-COMBI 38 FF (GB)
▶ Assemble the EEPROM marked "38 kW"

I istruzioni d'impiego

ATTENZIONE

CONSERVARE LA EEPROM DEL NUOVO CIRCUITO
eccetto per gli apparecchi seguenti :

3665092 E-COMBI 24 FF (GB)
3300355 E-COMBI 24 NG (GB)
3300353 E-SYSTEM 24 NG (GB)
▶ Montare l'EEPROM "24 kW"

3665093 E-COMBI 30 FF (GB)
3300354 E-SYSTEM 30 NG (GB)
▶ Montare l'EEPROM "30 kW"

3665094 E-COMBI 38 FF (GB)
▶ Montare l'EEPROM "38 kW"

ES manual de instrucciones

ADVERTENCIAS

CONSERVAR LA EEPROM DEL NUEVO CIRCUITO
excepto para los siguientes aparatos :

3665092 E-COMBI 24 FF (GB)
3300355 E-COMBI 24 NG (GB)
3300353 E-SYSTEM 24 NG (GB)
▶ Instalar el EEPROM "24 kW"

3665093 E-COMBI 30 FF (GB)
3300354 E-SYSTEM 30 NG (GB)
▶ Instalar el EEPROM "30 kW"

3665094 E-COMBI 38 FF (GB)
▶ Instalar el EEPROM "38 kW"

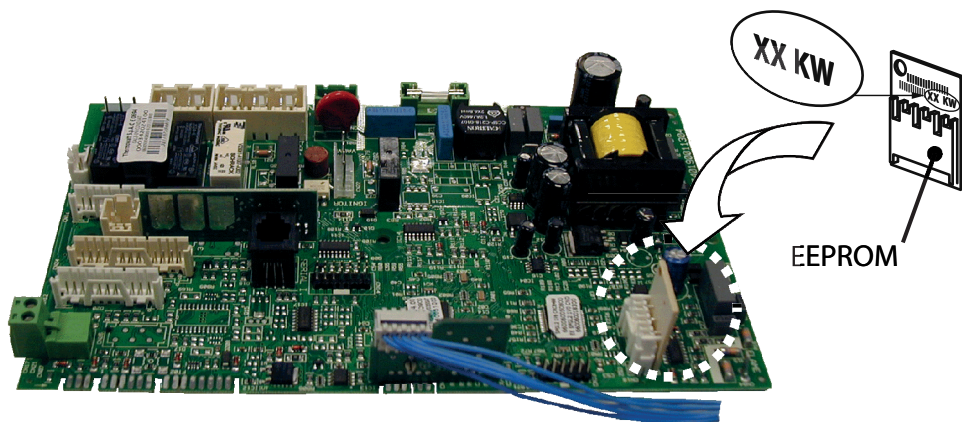

INFORMATION

Remplace les circuits imprimés :

00034201580x	00034201330x
00034201610x	00034201390x
00034201290x	00034201120x
00034201650x	00034200680x

INFORMATION

Replace the printed circuit :

00034201580x	00034201330x
00034201610x	00034201390x
00034201290x	00034201120x
00034201650x	00034200680x

CONFIGURATION

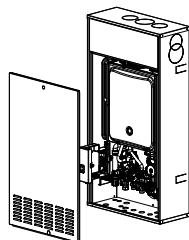
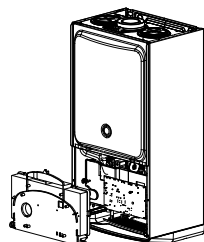

CONFIGURATION

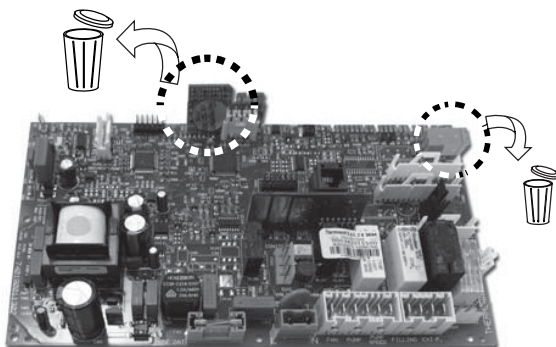
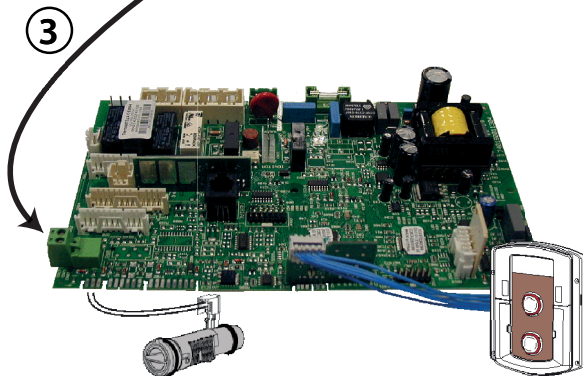
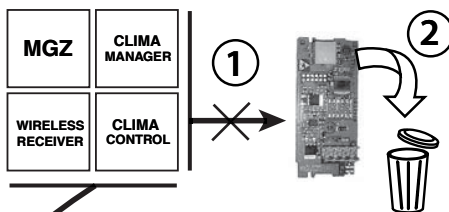

REGLAGES

PARAMETRAGE DE LA LANGUE D’AFFICHAGE (Si nécessaire)

1. Allumer la chaudière avec la touche ON/OFF.
2. Pousser la touche MENU/OK : apparaîtra le numéro ‘0’ clignotant (en bas apparaît le texte : ‘Heure-Date-Langue’).
3. Pousser à nouveau MENU/OK. Apparaîtra le numéro ‘00’ avec le deuxième chiffre clignotant (langue).
4. Pousser à nouveau MENU/OK et faire tourner le bouton de réglage de ‘température chauffage’ jusqu’à visualiser la langue désirée.
5. Une fois sélectionnée la langue désirée, pousser MENU/OK pour confirmer.
6. Pousser plusieurs fois ‘ESC’ jusqu’à retourner à l’écran principal.

PARAMETRES A VERIFIER :

Configurer les paramètres ci-dessous suivant les indications du tableau pages 7>20.

- Paramètre 21 : **Code accès : 234**
- Paramètre 220 : Allumage Lent
- Paramètre 223 : Selection Thermostat plancher ou Thermostat Ambiance zone 2
- Paramètre 227 : Room regulation device
- Paramètre 228 : Version chaudière
- Paramètre 229 : Puissance chaudière
- Paramètre 231 : Réglage puissance chauff. max.
- Paramètre 232 : Pourcentage RPM max. sanitaire
- Paramètre 233 : Pourcentage RPM mini
- Paramètre 234 : Pourcentage RPM max. chauffage
- Parameter 245 : *Pour Ecoflam seulement
- Paramètre 247 : Indication dispositif pourpression circuit chauffage
- Parameter 248 : Habilitation remplissage automatique
- Parameter 250 : Comfort
- Paramètre 253 : Extinction du brûleur en sanitaire
- Parameter 302 : Réglage Temp. réduite accu
- Parameter 325 : Min Collect Temp Démarr Pompe
- Parameter 329 : Temp Antigél Collecteur
- Parameter 870 : Basic ou Expert (CHX Fr Seulement)

Effectuer le réglage des paramètres en fonction de la configuration de l’installation (voir la notice d’installation).

ADJUSTMENTS

SETTING THE LANGUAGE

1. Press the ON/OFF key to turn on the boiler.
2. Press Menu/OK. A blinking ‘0’ is displayed (The following text is displayed on the line below “Time-Date-Language”).
3. Press Menu/OK again. The numbers ‘00’ will appear, with the second number blinking (language).
4. Press Menu/OK and turn the button of adjustment of ‘temperature heating’ to set language.
5. After selecting the language, press Menu/OK to confirm.
6. Press ‘ESC’ to return to the main screen.

PARAMETERS TO BE CHECKED :

Configure the parameters below according to the indications of the table pages 7>20.

- Parameter 21 : **Acces code : 234**
 - Parameter 220 : Soft ignition
 - Parameter 223 : Underfloor Thermostat or zone 2 ambient thermostat selection
 - Parameter 227 : Room regulation device
 - Parameter 228 : Boiler version
 - Parameter 229 : Power output
 - Parameter 231 : Max. CH Adjustable
 - Paramètre 232 : Domestic hot water maximum RPM percentage
 - Paramètre 233 : Minimum RPM percentage
 - Paramètre 234 : Heating maximum RPM percentage
 - Parameter 245 : *For Ecoflam only
 - Parameter 247 : CH Press Detection Device
 - Parameter 248 : Semi-auto filling
 - Parameter 250 : Comfort
 - Parameter 253 : DHW Switch Off Logic
 - Parameter 302 : Storage Reduced Temp.
 - Parameter 325 : Min Collector temp Pump ON
 - Parameter 329 : Collector Frost Protection Temp
 - Parameter 870 : Basic or Expert (CHX Fr Only)
- Adjust the parameters according to the configuration of the installation (*see the installation instructions*).

INFORMAZIONI

Sostituisce i circuiti stampati :

00034201580x	00034201330x
00034201610x	00034201390x
00034201290x	00034201120x
00034201650x	00034200680x

INFORMACIÓN

Sustituya los circuitos impresos :

00034201580x	00034201330x
00034201610x	00034201390x
00034201290x	00034201120x
00034201650x	00034200680x

CONFIGURAZIONE

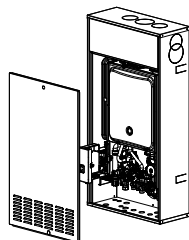
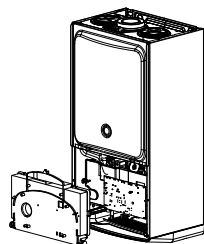

CONFIGURACIÓN

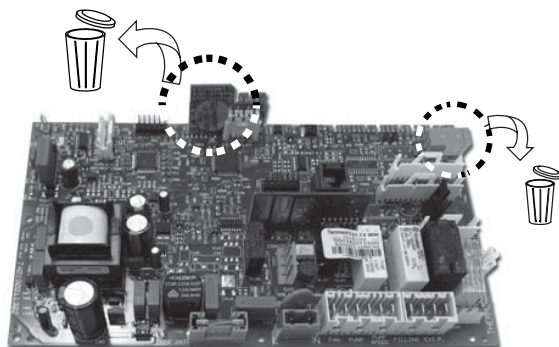
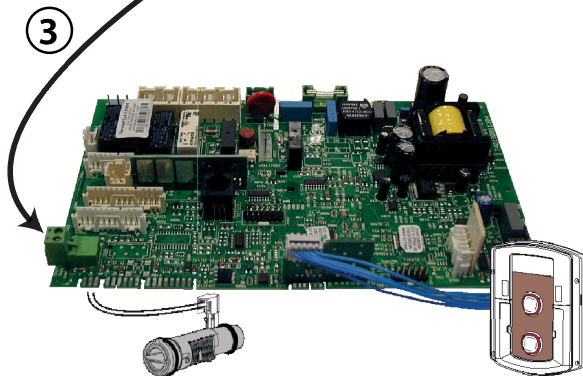
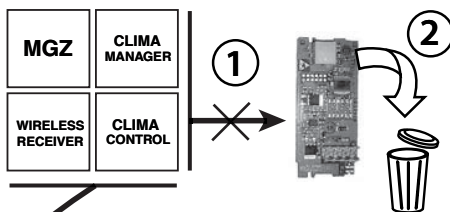

REGOLAZIONE

PARAMETRIZZAZIONE LINGUA

1. Accendere la caldaia con il tasto ON/OFF.
2. Premere il pulsante MENÙ/OK: comparirà il numero '0' lampeggiante (In basso compare il testo: 'Ora-Data-Lingua').
3. Premere di nuovo MENÙ/OK. Comparirà il numero '00' con la seconda cifra lampeggiante (lingua).
4. Premere di nuovo MENÙ/OK e ruotare la manopola regolazione 'temperatura riscaldamento' fino a visualizzare la lingua desiderata.
5. Una volta selezionata la lingua desiderata, premere MENÙ/OK per confermare.
6. Premere ripetutamente 'ESC' fino a tornare alla videata principale.

PARAMETRI DA VERIFICARE :

Configurare i parametri qui di seguito secondo le indicazioni della tabella a pagine 7>20.

- Parametro **21** : **Codice d'accesso : 234**
- Parametro **220** : Lenta accensione
- Parametro **223** : Selezione Termostato a pavimento o Termostato Ambiente 2
- Parameter **227** : Room regulation device
- Parametro **228** : Versione Caldaia
- Parametro **229** : Potenza Caldaia
- Parametro **231** : Massima potenza Riscaldamento regolabile
- Paramètre **232** : Percentuale RPM Max San.
- Paramètre **233** : Percentuale RPM min
- Paramètre **234** : Percentuale RPM Max Riscaldamento
- Parameter **245** : *Per Ecoflam soltanto
- Parametro **247** : Indicazione dispositivo per rilevazione pressione risc.
- Parameter **248** : Abilitaz. Riempim Semiautomatico
- Parameter **250** : Comfort
- Parametro **253** : Logica spegimento bruciatore in sanitario
- Parameter **302** : Impostaz T Ridotta Accumulo
- Parameter **325** : Min T Collett x Avvio\Pompa
- Parameter **329** : T Antigelo Collettore
- Parameter **870** : Basic o Expert (CHX Fr soltanto)

Effettuare la regolazione dei parametri in funzione della configurazione dell'installazione (vedi la nota d'installazione)

AJUSTES

CONFIGURACIÓN DEL IDIOMA (si necesario)

1. Encender la caldera con la tecla ON/OFF
2. Apretar la tecla MENU/OK: aparecerá el número '0' parpadeando (abajo aparece el texto: "Hora-Fecha-Idioma").
3. Apretar de nuevo la tecla MENU/OK. Aparece el número '00' con el segundo número parpadeando (idioma).
4. Apretar de nuevo la tecla MENU/OK y girar el mando de ajustes de 'temperatura calefacción' hasta visualizar el idioma deseado.
5. Una vez seleccionado el idioma deseado, apretar la tecla MENU/OK para confirmar
6. Apretar varias veces la tecla 'ESC' hasta volver a la pantalla del menú principal.

PARAMETROS CHE SE DEBEN COMPROBAR :

Configurar los siguientes parámetros según las indicaciones de la tabla de las páginas 7>20.

- Parámetro **21** : **Código acceso: 234**
- Parámetro **220** : Encendido lento
- Parámetro **223** : Selección Termostato suelo radiante o Termostato ambiente zona 2
- Parámetro **227** : Accesorio regulación ambiente
- Parámetro **228** : Versión caldera
- Parámetro **229** : Potencia caldera
- Parámetro **231** : Ajuste potencia calef. máx
- Parámetro **232** : Porcentaje RPM máx. sanitario
- Parámetro **233** : Porcentaje RPM mín.
- Parámetro **234** : Porcentaje RPM máx. calef.
- Parámetro **245** : *Para Ecoflam solamente
- Parámetro **247** : Indicación dispositivo de detección de presión calef.
- Parámetro **248** : Habilitación llenado automático
- Parámetro **250** : Comfort
- Parámetro **253** : Apagado del quemador sanitario
- Parámetro **302** : Ajustes temp. reducida acu.
- Parámetro **325** : Temp mín. colector arranque bomba
- Parámetro **329** : Temp antihielo colector
- Parámetro **870** : Básico o Expert (CHX Fr solamente)

Realizar el ajuste de los parámetros en función de la configuración de la instalación (ver manual de instalación).

GENUS PREMIUM		Parameters - Paramètres - Parametri - Parametros																
		220	223	227	228	229	231	232	233	234	247	248	250	253	302	325	329	870
3665012	GENUS PREMIUM 24	60	0	1	0		60	98	5	85	2	1	0	0	10	30	-20	
3300324	GENUS PREMIUM 24 NG MOD	60	0	1	0		60	98	5	85	2	1	0	0	10	30	-20	
3665013	GENUS PREMIUM 30	60	0	1	0		60	89	1	80	2	1	0	0	10	30	-20	
3300325	GENUS PREMIUM 30 NG MOD	60	0	1	0		60	89	1	80	2	1	0	0	10	30	-20	
3665014	GENUS PREMIUM 35	60	0	1	0		60	89	1	80	2	1	0	0	10	30	-20	
3300326	GENUS PREMIUM 35 NG MOD	60	0	1	0		60	89	1	80	2	1	0	0	10	30	-20	
3665017	GENUS PREMIUM 30	50	0	1	0		60	89	1	80	2	0	0	0	10	30	-20	
3665025	GENUS PREMIUM 24	60	0	1	0		60	98	5	85	2	1	0	0	10	30	-20	
3665029	GENUS HE 24 FF	60	0	1	0		60	98	5	85	2	0	0	1	10	30	-20	
3665030	GENUS HE 30 FF	60	0	1	0		60	89	1	80	2	0	0	1	10	30	-20	
3665031	GENUS HE 38 FF	60	0	1	0		60	89	1	70	2	0	0	1	10	30	-20	
3665036	GENUS PREMIUM 24	60	0	1	0		60	98	5	85	2	1	0	0	10	30	-20	
3665037	GENUS PREMIUM 35	60	0	1	0		60	89	1	80	2	1	0	0	10	30	-20	
3665038	GENUS PREMIUM 35	60	0	1	0		60	89	1	80	2	1	0	0	10	30	-20	
3665039	GENUS PREMIUM 24	60	0	1	0		60	98	5	85	2	1	0	0	10	30	-20	
3665040	GENUS PREMIUM 30	60	0	1	0		60	89	1	80	2	1	0	0	10	30	-20	
3665041	GENUS PREMIUM 35	60	0	1	0		60	89	1	80	2	1	0	0	10	30	-20	
3665052	GENUS PREMIUM 24	60	0	1	0		60	98	5	85	2	0	0	0	10	30	-20	
3665053	GENUS PREMIUM 30	60	0	1	0		60	89	1	80	2	0	0	0	10	30	-20	
3665054	GENUS PREMIUM 35	60	0	1	0		60	89	1	80	2	0	0	0	10	30	-20	
3665059	GENUS PREMIUM 24	60	0	1	0		60	98	5	85	2	1	0	0	10	30	-20	
3665060	GENUS PREMIUM 30	60	0	1	0		60	89	1	80	2	1	0	0	10	30	-20	
3665063	GENUS PREMIUM 24	60	0	1	0		60	98	5	85	2	1	0	0	10	30	-20	
3665064	GENUS PREMIUM 30	60	0	1	0		60	89	1	80	2	1	0	0	10	30	-20	

GENUS PREMIUM		Parameters - Paramètres - Parametri - Parametros																
		220	223	227	228	229	231	232	233	234	247	248	250	253	302	325	329	870
3665065	GENUS PREMIUM 24	60	0	1	0		60	98	5	85	2	1	0	0	10	30	-20	
3665066	GENUS PREMIUM 30	60	0	1	0		60	89	1	80	2	1	0	0	10	30	-20	
3665067	GENUS PREMIUM 35	60	0	1	0		60	89	1	80	2	1	0	0	10	30	-20	
3665068	GENUS PREMIUM 35	60	0	1	0		60	89	1	80	2	1	0	0	10	30	-20	
3665069	GENUS PREMIUM 35	60	0	1	0		60	89	1	80	2	1	0	0	10	30	-20	
3300290	GENUS PREMIUM SOLAR 24	60	0	1	0		60	98	5	85	2	1	0	1	10	30	-20	
3300349	GENUS PREMIUM 24 MOD IT-PI	60	0	1	0		60	98	5	85	2	1	0	0	10	30	-20	
3300350	GENUS PREMIUM 30 MOD IT-PI	60	0	1	0		60	89	1	80	2	1	0	0	10	30	-20	
3300351	GENUS HE 24 MOD UK	60	0	1	0		60	98	5	85	2	0	0	0	10	30	-20	
3300352	GENUS HE 30 MOD UK	60	0	1	0		60	89	1	80	2	0	0	0	10	30	-20	

GENUS PREMIUM SYSTEM		Parameters - Paramètres - Parametri - Parametros																
		220	223	227	228	229	231	232	233	234	247	248	250	253	302	325	329	870
3665027	GENUS PREMIUM SYSTEM 24	60	0	1	2		60	98	5	85	2	1	1	0	10	30	-20	
3665034	GENUS HE 24 FF SYSTEM	60	0	1	2		60	98	5	85	2	0	1	0	10	30	-20	
3665035	GENUS HE 30 FF SYSTEM	60	0	1	2		60	89	1	80	2	0	1	0	10	30	-20	
3665042	GENUS PREMIUM SYSTEM 24	60	0	1	2		60	98	5	85	2	1	1	0	10	30	-20	
3300329	GENUS PREMIUM SYSTEM 24 NG	60	0	1	1		60	98	5	85	2	1	1	0	10	30	-20	
3665043	GENUS PREMIUM SYSTEM 30	60	0	1	2		60	89	1	80	2	1	1	0	10	30	-20	
3300333	GENUS PREMIUM SYSTEM 30 NG	60	0	1	1		60	89	1	80	2	1	1	0	10	30	-20	
3665044	GENUS PREMIUM SYSTEM 24	60	0	1	2		60	98	5	85	2	1	1	0	10	30	-20	
3665044	GENUS PREMIUM SYSTEM 24	60	0	1	1		60	98	5	85	2	1	1	0	10	30	-20	
3665045	GENUS PREMIUM SYSTEM 30	60	0	1	2		60	89	1	80	2	1	1	0	10	30	-20	

GENUS PREMIUM SYSTEM		Parameters - Paramètres - Parametri - Parametros																
		220	223	227	228	229	231	232	233	234	247	248	250	253	302	325	329	870
3665045	GENUS PREMIUM SYSTEM 30	60	0	1	1		60	89	1	80	2	1	1	0	10	30	-20	
3665046	GENUS PREMIUM SYSTEM 24	60	0	1	2		60	98	5	85	2	1	1	0	10	30	-20	
3665046	GENUS PREMIUM SYSTEM 24	60	0	1	1		60	98	5	85	2	1	1	0	10	30	-20	
3665047	GENUS PREMIUM SYSTEM 30	60	0	1	2		60	89	1	80	2	1	1	0	10	30	-20	
3665047	GENUS PREMIUM SYSTEM 30	60	0	1	1		60	89	1	80	2	1	1	0	10	30	-20	
3665061	GENUS PREMIUM SYSTEM 24	60	0	1	2		60	98	5	85	2	1	1	0	10	30	-20	
3665062	GENUS PREMIUM SYSTEM 30	60	0	1	2		60	89	1	80	2	1	1	0	10	30	-20	
3665090	GENUS PREMIUM SYSTEM 30	60	0	1	2		60	89	1	80	2	1	1	0	10	30	-20	
3665095	GENUS PREMIUM SYSTEM 12	60	0	1	2		99	70	0	70	2	1	1	0	10	30	-20	
3300327	GENUS PREMIUM SYSTEM 12 NG	60	0	1	1	12	99	70	0	70	2	1	1	0	10	30	-20	
3665096	GENUS PREMIUM SYSTEM 18	60	0	1	2		99	80	2	80	2	1	1	0	10	30	-20	
3300328	GENUS PREMIUM SYSTEM 18 NG	60	0	1	1		99	80	2	80	2	1	1	0	10	30	-20	
3665115	GENUS PREMIUM SYSTEM 12	60	0	1	1		99	70	0	70	2	1	1	0	10	30	-20	
3665116	GENUS PREMIUM SYSTEM 18	60	0	1	1		99	80	2	80	2	1	1	0	10	30	-20	
3300291	GENUS PREMIUM SYS.SOLAR 12	60	0	1	1		99	70	0	70	2	1	1	0	10	30	-20	

GENUS PREMIUM FS		Parameters - Paramètres - Parametri - Parametros																
		220	223	227	228	229	231	232	233	234	247	248	250	253	302	325	329	870
3121488	GENUS PREMIUM FS 12 EAA1	96	0	1	4		99	75	1	75	2	0	2	1	40	30	-20	
3124527	GENUS PREMIUM FS 25 EAA1	54	0	1	4		99	95	4	81	2	0	2	1	40	30	-20	
3124528	GENUS PREMIUM FS 35 EAA1	59	0	1	4		99	91	0	88	2	0	2	1	40	30	-20	
3124513	GENUS PREMIUM SOLAR FS 12 IT-PI	96	0	1	4		99	75	1	75	2	0	2	1	40	30	-20	
3124514	GENUS PREMIUM SOLAR FS 25 IT-PI	54	0	1	4		99	95	4	81	2	0	2	1	40	30	-20	
3124515	GENUS PREMIUM SOLAR FS 35 IT-PI	59	0	1	4		99	91	0	88	2	0	2	1	40	30	-20	
3124525	GENUS PREMIUM SOL FS 25 EAA1	54	0	1	4		99	95	4	81	2	0	2	1	40	30	-20	
3124526	GENUS PREMIUM SOL FS 35 EAA1	59	0	1	4		99	91	0	88	2	0	2	1	40	30	-20	

TALIA GREEN		Parameters - Paramètres - Parametri - Parametros																
		220	223	227	228	229	231	232	233	234	247	248	250	253	302	325	329	870
3650127	TALIA GREEN 25 FF	50	0	1	0		60	98	5	85	1	0	2	1	10	30	-20	
3650128	TALIA GREEN 30 FF	50	0	1	0		60	89	1	80	1	0	2	1	10	30	-20	
3650129	TALIA GREEN 35 FF	50	0	1	0		60	89	1	80	1	0	2	1	10	30	-20	
3650130	TALIA GREEN 25 FF	60	0	1	0		60	98	5	85	1	0	2	1	10	30	-20	
3650131	TALIA GREEN 30 FF	60	0	1	0		60	89	1	80	1	0	2	1	10	30	-20	
3650132	TALIA GREEN 35 FF	60	0	1	0		60	89	1	80	1	0	2	1	10	30	-20	
3310066	TALIA GREEN 25 FF NG	60	0	1	0		60	98	5	85	1	0	2	1	10	30	-20	
3310067	TALIA GREEN 30 FF NG	60	0	1	0		60	89	1	80	1	0	2	1	10	30	-20	
3310068	TALIA GREEN 35 FF NG	60	0	1	0		60	89	1	80	1	0	2	1	10	30	-20	
3650133	TALIA GREEN 25 FF	60	0	1	0		60	98	5	85	1	0	2	1	10	30	-20	
3650134	TALIA GREEN 30 FF	60	0	1	0		60	89	1	80	1	0	2	1	10	30	-20	
3650135	TALIA GREEN 35 FF	60	0	1	0		60	89	1	80	1	0	2	1	10	30	-20	
3650302	TALIA GREEN 25 FF	60	0	1	0		60	98	5	85	1	0	2	1	10	30	-20	
3650303	TALIA GREEN 30 FF	50	0	1	0		60	89	1	80	1	0	2	1	10	30	-20	
3650304	TALIA GREEN 35 FF	60	0	1	0		60	89	1	80	1	0	2	1	10	30	-20	

TALIA GREEN SYSTEM		Parameters - Paramètres - Parametri - Parametros																
		220	223	227	228	229	231	232	233	234	247	248	250	253	302	325	329	870
3650140	TALIA GREEN SYSTEM 25 FF	50	0	1	1		60	98	5	85	1	0	2	1	10	30	-20	
3310099	TALIA GREEN SYSTEM 25 FF N FR	50	0	1	1		60	98	5	85	1	0	2	1	10	30	-20	0
3650141	TALIA GREEN SYSTEM 30 FF	50	0	1	1		60	89	1	80	1	0	2	1	10	30	-20	
3650142	TALIA GREEN SYSTEM 35 FF	50	0	1	1		60	89	1	80	1	0	2	1	10	30	-20	
3310108	TALIA GREEN SYSTEM 35 FF	60	0	1	1		60	89	1	80	1	0	2	1	10	30	-20	0
3650143	TALIA GREEN SYSTEM 25 FF	60	0	1	1		60	98	5	85	1	0	2	1	10	30	-20	
3310036	TALIA GREEN SYSTEM 25 NG FF	60	0	1	1		60	98	5	85	1	0	2	1	10	30	-20	
3650144	TALIA GREEN SYSTEM 30 FF	60	0	1	1		60	89	1	80	1	0	2	1	10	30	-20	
3310037	TALIA GREEN SYSTEM 30 NG FF	60	0	1	1		60	89	1	80	1	0	2	1	10	30	-20	
3650145	TALIA GREEN SYSTEM 35 FF	60	0	1	1		60	89	1	80	1	0	2	1	10	30	-20	
3310038	TALIA GREEN SYSTEM 35 NG FF	60	0	1	1		60	89	1	80	1	0	2	1	10	30	-20	
3650146	TALIA GREEN SYSTEM 25 FF	60	0	1	1		60	98	5	85	1	0	2	1	10	30	-20	
3650147	TALIA GREEN SYSTEM 30 FF	60	0	1	1		60	89	1	80	1	0	2	1	10	30	-20	
3650148	TALIA GREEN SYSTEM 35 FF	60	0	1	1		60	89	1	80	1	0	2	1	10	30	-20	
3650250	TALIA GREEN SYSTEM 12 FF	60	0	1	1		99	70	0	70	1	0	2	1	10	30	-20	
3650251	TALIA GREEN SYSTEM 12 FF	60	0	1	1		99	70	0	70	1	0	2	1	10	30	-20	
3310034	TALIA GREEN SYSTEM 12 FF N	60	0	1	1		99	70	0	70	1	0	2	1	10	30	-20	
3650261	TALIA GREEN SYSTEM 18 FF	50	0	1	1		99	80	2	80	1	0	2	1	10	30	-20	
3310107	TALIA GREEN SYSTEM 18 FF N FR	50	0	1	1		99	80	2	80	1	0	2	1	10	30	-20	0
3310035	TALIA GREEN SYSTEM 18 FF N	50	0	1	1		99	80	2	80	1	0	2	1	10	30	-20	
3310137	TALIA GREE SYSTEM 12 FF N NR	60	0	1	1		60	91	0	70	1	0	2	1	10	30	-20	0
3310023	TALIA GREEN SYSTEM SOLAR 18	50	0	1	1		99	80	2	80	1	0	2	1	10	30	-20	

MIRA C GREEN		Parameters - Paramètres - Parametri - Parametros																
		220	223	227	228	229	231	232	233	234	247	248	250	253	302	325	329	870
3310083	MIRA C GREEN 25 FF N FR	60	0	1	0		60	89	1	80	1	0	2	1	10	30	-20	
3310104	MIRA C GREEN 30 FF N FR	60	0	1	0		60	89	1	80	1	0	2	1	10	30	-20	0
3310112	MIRA C GREEN 35 FF N FR	60	0	1	0		60	89	1	80	1	0	2	1	10	30	-20	
3310121	MIRA C GREEN 25FF P	60	0	1	0		60	89	1	80	1	0	2	1	10	30	-20	0
3650287	MIRA C GREEN 35 FF	60	0	1	0		60	89	1	80	1	0	2	1	10	30	-20	0
3650288	MIRA C GREEN 30 FF	60	0	1	0		60	89	1	80	1	0	2	1	10	30	-20	0
3650289	MIRA C GREEN 25 FF	60	0	1	0		60	98	5	85	1	0	2	1	10	30	-20	
3650339	MIRA C GREEN 25 FF P	60	0	1	0		60	98	5	85	1	0	2	1	10	30	-20	0
3650288	MIRA C GREEN 30 FF	60	0	1	0		60	98	5	85	1	0	2	1	10	30	-20	0
3650289	MIRA C GREEN 25 FF	60	0	1	0		60	99	16	85	1	0	2	1	10	30	-20	
3650339	MIRA C GREEN 25 FF P	60	0	1	0		60	99	16	85	1	0	2	1	10	30	-20	0

PIGMA GREEN		Parameters - Paramètres - Parametri - Parametros																
		220	223	227	228	229	231	232	233	234	247	248	250	253	302	325	329	870
3650136	PIGMA GREEN 25 FF	50	0	1	0		60	98	5	85	1	0	2	1	10	30	-20	
3650137	PIGMA GREEN 30 FF	50	0	1	0		60	89	1	80	1	0	2	1	10	30	-20	
3650138	PIGMA GREEN 25 FF	60	0	1	0		60	98	5	85	1	0	2	1	10	30	-20	
3310048	PIGMA GREEN 25 FF NG	60	0	1	0		60	98	5	85	1	0	2	1	10	30	-20	
3650139	PIGMA GREEN 30 FF	60	0	1	0		60	89	1	80	1	0	2	1	10	30	-20	
3310049	PIGMA GREEN 30 FF NG	60	0	1	0		60	89	1	80	1	0	2	1	10	30	-20	
3310050	PIGMA GREEN 30 B/P	60	0	1	0		60	89	1	80	1	0	2	1	10	30	-20	
3650271	PIGMA GREEN 35 FF	50	0	1	0		60	89	1	80	1	0	2	1	10	30	-20	
3650278	PIGMA GREEN 25 FF	60	0	1	0		60	98	5	85	1	0	2	1	10	30	-20	
3650279	PIGMA GREEN 30 FF	60	0	1	0		60	89	1	80	1	0	2	1	10	30	-20	
3650343	PIGMA GREEN 30 B/P PI	60	0	1	0		60	89	1	80	1	0	2	1	10	30	-20	

URBIA GREEN		Parameters - Paramètres - Parametri - Parametros																
		220	223	227	228	229	231	232	233	234	247	248	250	253	302	325	329	870
3650121	URBIA GREEN 25 FF	50	0	1	3		60	98	5	85	2	0	2	1	35	30	-20	
3310084	URBIA GREEN 25 FF	50	0	1	3		60	98	5	85	2	0	2	1	35	30	-20	0
3650122	URBIA GREEN 30 FF	50	0	1	3		60	89	1	80	2	0	2	1	35	30	-20	
3310102	URBIA GREEN 30 FF N FR-BE	50	0	1	3		60	89	1	80	2	0	2	1	35	30	-20	0
3650123	URBIA GREEN 35 FF	50	0	1	3		60	89	1	80	2	0	2	1	35	30	-20	
3310120	URBIA GREEN 35 FF N FR-BE	50	0	1	3		60	89	1	80	2	0	2	1	35	30	-20	0
3650124	URBIA GREEN 25 FF	60	0	1	3		60	98	5	85	2	0	2	1	35	30	-20	
3310024	URBIA GREEN 24 NG FF	60	0	1	3		60	98	5	85	2	0	2	1	35	30	-20	
3650125	URBIA GREEN 30 FF	60	0	1	3		60	89	1	80	2	0	2	1	35	30	-20	
3310025	URBIA GREEN 30 NG FF	60	0	1	3		60	89	1	80	2	0	2	1	35	30	-20	
3650126	URBIA GREEN 35 FF	60	0	1	3		60	89	1	80	2	0	2	1	35	30	-20	
3310026	URBIA GREEN 35 NG FF	60	0	1	3		60	89	1	80	2	0	2	1	35	30	-20	
3650344	URBIA GREEN 25FF P	60	0	1	3		60	99	16	85	2	0	2	1	35	30	-20	
3310122	URBIA GREEN 25FF P	60	0	1	3		60	99	16	85	2	0	2	1	35	30	-20	0
3310124	URBIA GREEN 24 MOD FR	50	0	1	3		60	98	5	85	2	0	2	1	35	30	-20	
3310125	URBIA GREEN 30 MOD FR	50	0	1	3		60	89	1	80	2	0	2	1	35	30	-20	

SERELIA GREEN		Parameters - Paramètres - Parametri - Parametros																
		220	223	227	228	229	231	232	233	234	247	248	250	253	302	325	329	870
3650120	SERELIA GREEN 25 FF	50	0	1	3		60	98	5	85	2	0	2	1	35	30	-20	
3310092	SERELIA GREEN 25 FF	50	0	1	3		60	98	5	85	2	0	2	1	35	30	-20	0

NIAGARA C GREEN		Parameters - Paramètres - Parametri - Parametros																
		220	223	227	228	229	231	232	233	234	247	248	250	253	302	325	329	870
3650317	NIAGARA C GREEN 25 FR-BE	50	0	1	5		60	98	5	85	2	0	2	0	35	30	-20	
3310086	NIAGARA C GREEN 25	60	0	1	5		60	98	5	85	2	0	2	0	35	30	-20	0
3650318	NIAGARA C GREEN 35 FR-BE	50	0	1	5		60	89	1	80	2	0	2	0	35	30	-20	
3310098	NIAGARA C GREEN 35	60	0	1	5		60	89	1	80	2	0	2	0	35	30	-20	0
3650321	NIAGARA C GREEN 25 HMO	60	0	1	5		60	98	5	85	2	0	2	0	35	30	-20	
3650322	NIAGARA C GREEN 35 HMO	60	0	1	5		60	89	1	80	2	0	2	0	35	30	-20	
3650326	NIAGARA C GREEN 25 EE	60	0	1	5		60	98	5	85	2	0	2	0	35	30	-20	
3650327	NIAGARA C GREEN 35 EE	60	0	1	5		60	89	1	80	2	0	2	0	35	30	-20	
3310072	NIAGARA C GREEN 25	60	0	1	5		60	98	5	85	2	0	2	0	35	30	-20	
3310073	NIAGARA C GREEN 35	60	0	1	5		60	89	1	80	2	0	2	0	35	30	-20	
3650345	NIAGARA C GREEN 25FF P	60	0	1	5		60	99	16	85	2	0	2	0	35	30	-20	
3310123	NIAGARA C GREEN 25FF P	60	0	1	5		60	99	16	85	2	0	2	0	35	30	-20	0

PHAROS ZELIOS / GREEN		Parameters - Paramètres - Parametri - Parametros																
		220	223	227	228	229	231	232	233	234	247	248	250	253	302	325	329	870
3124512	PHAROS ZELIOS 12	96	0	1	4		99	75	1	75	2	0	2	1	40	30	-20	
3123535	PHAROS ZELIOS 24	54	0	1	4		99	95	4	81	2	0	2	1	40	30	-20	
3123462	PHAROS GREEN 12	96	0	1	4		99	75	1	75	2	0	2	1	40	30	-20	
3123463	PHAROS GREEN 18	50	0	1	4		99	98	7	98	2	0	2	1	40	30	-20	
3123464	PHAROS GREEN 24	54	0	1	4		99	95	4	81	2	0	2	1	40	30	-20	
3123465	PHAROS GREEN 34	59	0	1	4		99	91	0	88	2	0	2	1	40	30	-20	
3123832	PHAROS ZELIOS 18	50	0	1	4		99	98	7	98	2	0	2	1	40	30	-20	
3123536	PHAROS ZELIOS 34	59	0	1	4		99	91	0	88	2	0	2	1	40	30	-20	

ECOFLAM		Parameters - Paramètres - Parametri - Parametros																
		220	223	227	228	229	231	232	233	234	247	248	250	253	302	325	329	870
3314021	ECOBLU 25 CPR	60	0	1	0		60	98	5	85	1	0	0	0	10	30	-20	
3314022	ECOBLU 12 SP/A	60	0	1	2		99	70	0	70	1	0	2	0	10	30	-20	
3314023	ECOBLU 25 SP/A	60	0	1	2		60	98	5	85	1	0	2	0	10	30	-20	
3300288	ECOBLU 25 CPR	60	0	1	0		60	98	5	85	1	0	0	0	10	30	-20	
3314031	ECOBLU 25 CPA MET	60	0	1	5		60	98	5	85	1	0	2	0	10	30	-20	
3314032	ECOBLU 35 CPA MET	60	0	1	5		60	89	1	80	1	0	2	0	10	30	-20	
3314029	ECOBLU 30 CPR MET	60	0	1	0		60	89	1	80	1	0	2	0	10	30	-20	

EXTERNAL / BUILT-IN		Parameters - Paramètres - Parametri - Parametros																
		220	223	227	228	229	231	232	233	234	247	248	250	253	302	325	329	870
3300262	GENUS PREMIUM IN 25 MET	60	0	1	0		60	98	5	85	2	1	0	0	10	30	-20	
3300263	EGIS PREMIUM IN 25 MET	60	0	1	0		60	98	5	85	1	0	0	0	10	90	-20	
3300269	GENUS PREMIUM IN SYSTEM 25 FF	60	0	1	2		60	98	5	85	2	1	2	0	10	30	-20	
3300270	GENUS PREMIUM IN SYSTEM 12 FF	60	0	1	2		99	70	0	70	2	1	2	0	10	30	-20	
3300278	GENUS PREMIUM EX 25 MET	60	0	1	0		60	98	5	85	2	1	0	0	10	30	-20	
3300372	GENUS PREMIUM SOLAR IN 25	60	0	1	2		60	98	5	85	2	1	2	0	10	30	-20	
3314008	ECOBLU 25 IN CPR MET	60	0	1	0		60	98	5	85	2	1	0	0	10	30	-20	
3314009	ECOBLU 12 IN SP/A MET	60	0	1	2		99	70	0	70	2	1	2	0	10	30	-20	
3314010	ECOBLU 25 IN SP/A MET	60	0	1	2		60	98	5	85	2	1	2	0	10	30	-20	
3314030	ECOBLU 25 EXT CPR MET	60	0	1	0		60	98	5	85	2	1	0	0	10	30	-20	
3314042	ECOBLU 25 SOLAR IN CPR	60	0	1	0		60	98	5	85	2	1	0	0	10	30	-20	
3310008	TALIA GREEN IN 25 MET	60	0	1	0		60	98	5	85	2	1	0	0	10	30	-20	
3310013	TALIA GREEN IN SYSTEM 25	60	0	1	2		60	98	5	85	2	1	2	0	10	30	-20	
3310014	TALIA GREEN IN SYSTEM 12	60	0	1	2		99	70	0	70	2	1	2	0	10	30	-20	
3310019	ALIXIA GREEN IN 25 MET	60	0	1	0		60	98	5	85	1	0	0	0	10	90	-20	
3310131	TALIA GREEN ZELIOS IN25	60	0	1	0		60	98	5	85	1	0	0	0	10	30	-20	
3310020	TALIA GREEN EXT 25 MET	60	0	1	0		60	98	5	85	2	1	0	0	10	30	-20	