

Cree® XLamp® XP Family LEDs

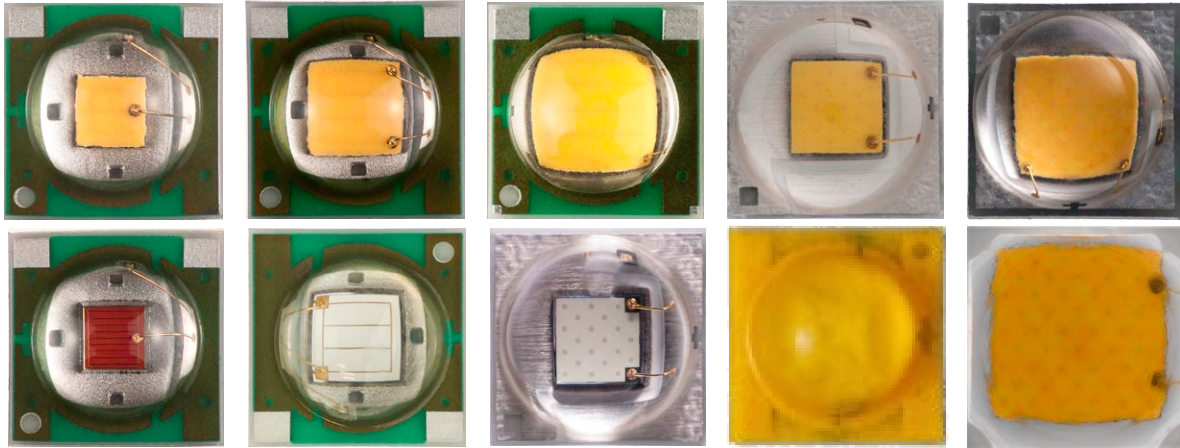

TABLE OF CONTENTS

| | | | |
|--|----|---|----|
| Introduction..... | 2 | XP-E2 Neutral White, Outdoor White | 31 |
| Bin and Order Code Format..... | 3 | XP-E2 Warm White | 33 |
| Performance Groups – Brightness | 5 | XP-E2 Color | 34 |
| Performance Groups – Radiant Flux..... | 6 | XP-E2 Warm White | 34 |
| Performance Groups – Chromaticity | 7 | XP-E HEW ANSI Cool White..... | 37 |
| Performance Groups – Dominant Wavelength | 12 | XP-E HEW Neutral White, Outdoor White | 38 |
| Performance Groups – Forward Voltage | 12 | XP-G ANSI Cool White..... | 40 |
| Cree’s Standard Chromaticity Regions Plotted on the 1931 CIE Curve..... | 13 | XP-G Neutral White, Outdoor White..... | 41 |
| Cree’s Standard Cool White Kits Plotted on ANSI Standard Chromaticity Regions..... | 15 | XP-G Warm White..... | 43 |
| Cree’s Outdoor White Kits Plotted on ANSI Standard Chromaticity Regions..... | 16 | XP-G2 ANSI Cool White | 45 |
| Cree’s Standard Warm and Neutral White Kits Plotted on ANSI Standard Chromaticity Regions..... | 18 | XP-G2 Neutral White, Outdoor White..... | 46 |
| Cree’s 2200 K CCT White Kits Plotted on ANSI Standard Chromaticity Regions..... | 20 | XP-G2 Warm White..... | 48 |
| Cree’s PC Amber Kit Plotted on the 1931 CIE Curve..... | 20 | XP-L ANSI Cool White | 50 |
| Cree’s Standard Chromaticity Kits | 21 | XP-L Neutral White | 51 |
| Standard Order Codes and Pre-ANSI Bins | | XP-L Warm White | 52 |
| XP-C Cool White | 22 | | |
| Standard Order Codes and Bins | | | |
| XP-C ANSI Cool White | 22 | | |
| XP-C Neutral White..... | 23 | | |
| XP-C Warm White..... | 24 | | |
| XP-C Color..... | 24 | | |
| XP-E Cool White | 26 | | |
| XP-E ANSI Cool White | 26 | | |
| XP-E Neutral White, Outdoor White | 27 | | |
| XP-E Warm White | 28 | | |
| XP-E Color..... | 29 | | |
| XP-E2 ANSI Cool White | 31 | | |

INTRODUCTION

This document describes the product nomenclature required to select and order Cree's XLamp® XP Family LEDs. XLamp XP Family LEDs are tested and sorted into bins which are then combined into orderable kits identified by an order code.

All XLamp LEDs are tested and sorted by color and brightness into a unique bin. Each bin contains LEDs from only one color and brightness group and is uniquely identified by a bin code. White XLamp LEDs are sorted by chromaticity (color) and luminous flux (brightness). High-Efficiency White (HEW) XLamp LEDs are additionally binned into forward voltage bins. Color XLamp LEDs are sorted by dominant wavelength (color) and luminous or radiant flux (brightness). Amber, red-orange and red LEDs are additionally binned into forward voltage bins. LEDs are shipped on reels containing LEDs from one bin and are always labeled with the appropriate bin code.

Kits contain LEDs from a number of similar bins and are fully defined by their order codes. A full explanation of the order codes for XLamp XP Family LEDs, as well as a list of standard order codes, is provided in this document.

BIN AND ORDER CODE FORMAT

XP-C, XP-E, XP-E2, XP-E HEW, XP-G and XP-G2 bin codes and order codes are configured in the following manner:

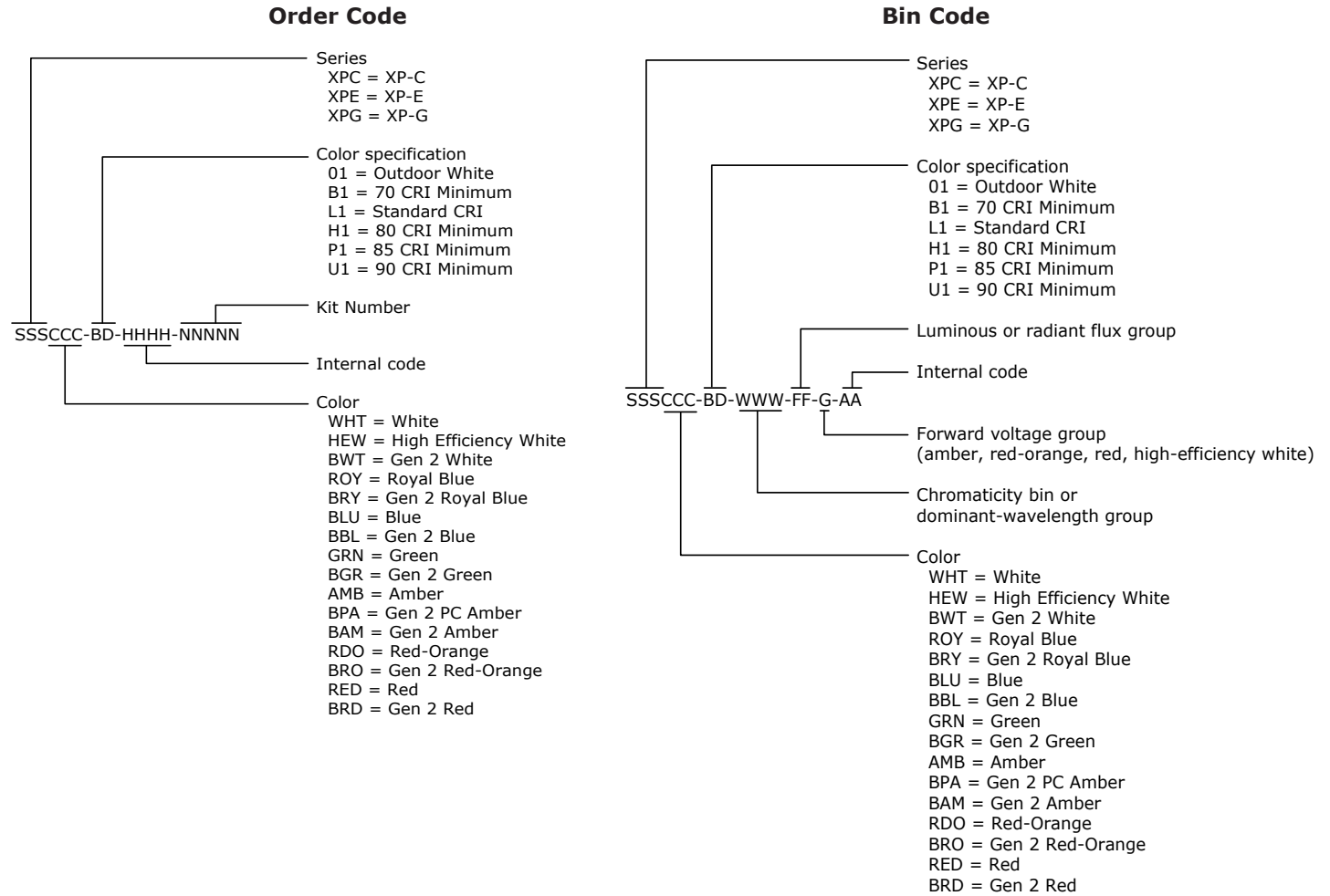

BIN AND ORDER CODE FORMAT - CONTINUED

XP-L bin codes and order codes are configured in the following manner:

Order Code

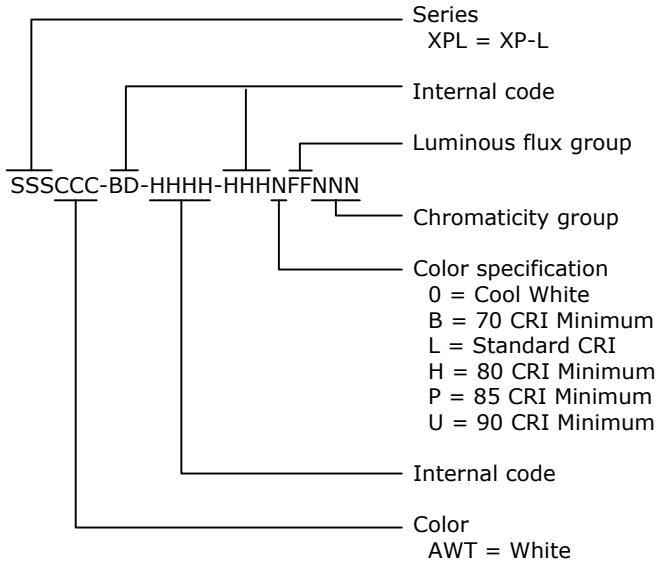

Bin Code

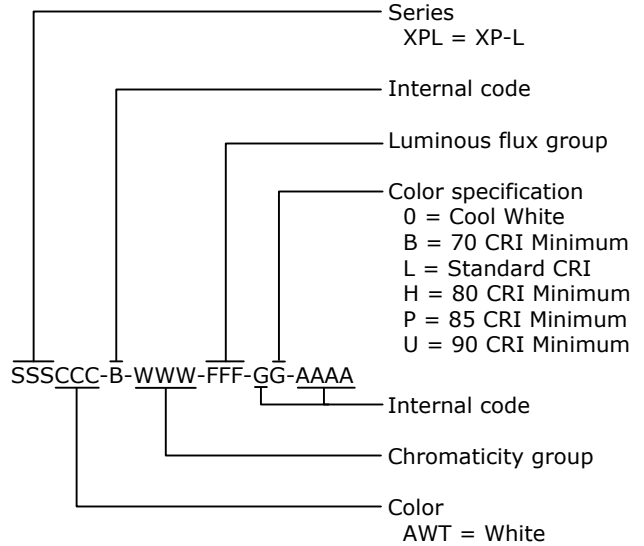

PERFORMANCE GROUPS – BRIGHTNESS

XLamp XP Family LEDs (except royal blue and XP-L) are tested for luminous flux and placed into one of the following luminous-flux groups:

| Group Code | Min. Luminous Flux @ 350 mA (lm) | Max. Luminous Flux @ 350 mA (lm) |
|------------|-------------------------------------|-------------------------------------|
| J | 23.5 | 30.6 |
| K2 | 30.6 | 35.2 |
| K3 | 35.2 | 39.8 |
| M2 | 39.8 | 45.7 |
| M3 | 45.7 | 51.7 |
| N2 | 51.7 | 56.8 |
| N3 | 56.8 | 62.0 |
| N4 | 62.0 | 67.2 |
| P2 | 67.2 | 73.9 |
| P3 | 73.9 | 80.6 |
| P4 | 80.6 | 87.4 |
| Q2 | 87.4 | 93.9 |
| Q3 | 93.9 | 100 |
| Q4 | 100 | 107 |
| Q5 | 107 | 114 |
| R2 | 114 | 122 |
| R3 | 122 | 130 |
| R4 | 130 | 139 |
| R5 | 139 | 148 |
| S2 | 148 | 156 |
| S3 | 156 | 164 |

XLamp XP-L LEDs are tested for luminous flux and placed into one of the following luminous-flux groups:

| Group Code | Min. Luminous Flux @ 1050 mA (lm) | Max. Luminous Flux @ 1050 mA (lm) |
|------------|--------------------------------------|--------------------------------------|
| T5 | 260 | 280 |
| T6 | 280 | 300 |
| U2 | 300 | 320 |
| U3 | 320 | 340 |
| U4 | 340 | 360 |
| U5 | 360 | 380 |
| U6 | 380 | 400 |
| V2 | 400 | 420 |
| V3 | 420 | 440 |
| V4 | 440 | 460 |
| V5 | 460 | 480 |
| V6 | 480 | 500 |

PERFORMANCE GROUPS – RADIANT FLUX ($T_j = 25\text{ °C}$)

XLamp XP-C and XP-E royal-blue LEDs are tested for radiant flux and sorted into one of the following radiant-flux bins:

| Group | Minimum Radiant Flux (mW) @ 350 mA | Maximum Radiant Flux (mW) @ 350 mA |
|-------|------------------------------------|------------------------------------|
| 12 | 250 | 300 |
| 13 | 300 | 350 |
| 14 | 350 | 425 |
| 15 | 425 | 500 |
| 16 | 500 | 600 |

XLamp XP-E2 royal blue LEDs are tested for radiant flux and placed into one the following bins:

| Group | Minimum Radiant Flux (mW) @ 350 mA | Maximum Radiant Flux (mW) @ 350 mA |
|--------|------------------------------------|------------------------------------|
| 31 (K) | 475 | 500 |
| 32 (L) | 500 | 525 |
| 33 (M) | 525 | 550 |
| 34 (N) | 550 | 575 |
| 35 (P) | 575 | 600 |
| 36 (Q) | 600 | 625 |

PERFORMANCE GROUPS – CHROMATICITY

White XLamp LEDs are tested for chromaticity and placed into one of the regions defined by the bounding coordinates on the following pages.

| Region | x | y | Region | x | y |
|--------|------|------|--------|------|------|
| WK | .283 | .284 | WF | .314 | .355 |
| | .295 | .297 | | .316 | .332 |
| | .298 | .288 | | .306 | .322 |
| | .287 | .276 | | .301 | .342 |
| WA | .292 | .306 | WP | .317 | .319 |
| | .295 | .297 | | .329 | .330 |
| | .283 | .284 | | .329 | .318 |
| | .279 | .291 | | .318 | .308 |
| WM | .295 | .297 | WD | .329 | .345 |
| | .308 | .311 | | .329 | .330 |
| | .310 | .300 | | .317 | .319 |
| | .298 | .288 | | .316 | .332 |
| WB | .306 | .322 | WG | .329 | .369 |
| | .308 | .311 | | .329 | .345 |
| | .295 | .297 | | .316 | .332 |
| | .292 | .306 | | .314 | .355 |
| WE | .301 | .342 | WJ | .329 | .330 |
| | .306 | .322 | | .329 | .345 |
| | .292 | .306 | | .346 | .359 |
| | .287 | .321 | | .344 | .342 |
| WN | .308 | .311 | WH | .348 | .384 |
| | .317 | .319 | | .346 | .359 |
| | .318 | .308 | | .329 | .345 |
| | .310 | .300 | | .329 | .369 |
| WC | .316 | .332 | | | |
| | .317 | .319 | | | |
| | .308 | .311 | | | |
| | .306 | .322 | | | |

PERFORMANCE GROUPS – CHROMATICITY (CONTINUED)

| Region | x | y | Region | x | y | Region | x | y | Region | x | y |
|--------|--------|--------|--------|--------|--------|--------|--------|--------|--------|--------|--------|
| 0A | 0.2950 | 0.2970 | 0B | 0.2920 | 0.3060 | 0C | 0.2984 | 0.3133 | 0D | 0.2984 | 0.3133 |
| | 0.2920 | 0.3060 | | 0.2895 | 0.3135 | | 0.2962 | 0.3220 | | 0.3048 | 0.3207 |
| | 0.2984 | 0.3133 | | 0.2962 | 0.3220 | | 0.3028 | 0.3304 | | 0.3068 | 0.3113 |
| | 0.3009 | 0.3042 | | 0.2984 | 0.3133 | | 0.3048 | 0.3207 | | 0.3009 | 0.3042 |
| 0R | 0.2980 | 0.2880 | 0S | 0.2895 | 0.3135 | 0T | 0.2962 | 0.3220 | 0U | 0.3037 | 0.2937 |
| | 0.2950 | 0.2970 | | 0.2870 | 0.3210 | | 0.2937 | 0.3312 | | 0.3009 | 0.3042 |
| | 0.3009 | 0.3042 | | 0.2937 | 0.3312 | | 0.3005 | 0.3415 | | 0.3068 | 0.3113 |
| | 0.3037 | 0.2937 | | 0.2962 | 0.3220 | | 0.3028 | 0.3304 | | 0.3093 | 0.2993 |
| 1A | 0.3048 | 0.3207 | 1B | 0.3028 | 0.3304 | 1C | 0.3115 | 0.3391 | 1D | 0.3130 | 0.3290 |
| | 0.3130 | 0.3290 | | 0.3115 | 0.3391 | | 0.3205 | 0.3481 | | 0.3213 | 0.3373 |
| | 0.3144 | 0.3186 | | 0.3130 | 0.3290 | | 0.3213 | 0.3373 | | 0.3221 | 0.3261 |
| | 0.3068 | 0.3113 | | 0.3048 | 0.3207 | | 0.3130 | 0.3290 | | 0.3144 | 0.3186 |
| 1R | 0.3068 | 0.3113 | 1S | 0.3005 | 0.3415 | 1T | 0.3099 | 0.3509 | 1U | 0.3144 | 0.3186 |
| | 0.3144 | 0.3186 | | 0.3099 | 0.3509 | | 0.3196 | 0.3602 | | 0.3221 | 0.3261 |
| | 0.3161 | 0.3059 | | 0.3115 | 0.3391 | | 0.3205 | 0.3481 | | 0.3231 | 0.3120 |
| | 0.3093 | 0.2993 | | 0.3028 | 0.3304 | | 0.3115 | 0.3391 | | 0.3161 | 0.3059 |
| 2A | 0.3215 | 0.3350 | 2B | 0.3207 | 0.3462 | 2C | 0.3290 | 0.3538 | 2D | 0.3290 | 0.3417 |
| | 0.3290 | 0.3417 | | 0.3290 | 0.3538 | | 0.3376 | 0.3616 | | 0.3371 | 0.3490 |
| | 0.3290 | 0.3300 | | 0.3290 | 0.3417 | | 0.3371 | 0.3490 | | 0.3366 | 0.3369 |
| | 0.3222 | 0.3243 | | 0.3215 | 0.3350 | | 0.3290 | 0.3417 | | 0.3290 | 0.3300 |
| 2R | 0.3222 | 0.3243 | 2S | 0.3196 | 0.3602 | 2T | 0.3290 | 0.3690 | 2U | 0.3290 | 0.3300 |
| | 0.3290 | 0.3300 | | 0.3290 | 0.3690 | | 0.3381 | 0.3762 | | 0.3366 | 0.3369 |
| | 0.3290 | 0.3180 | | 0.3290 | 0.3538 | | 0.3376 | 0.3616 | | 0.3361 | 0.3245 |
| | 0.3231 | 0.3120 | | 0.3207 | 0.3462 | | 0.3290 | 0.3538 | | 0.3290 | 0.3180 |
| 3A | 0.3371 | 0.3490 | 3B | 0.3376 | 0.3616 | 3C | 0.3463 | 0.3687 | 3D | 0.3451 | 0.3554 |
| | 0.3451 | 0.3554 | | 0.3463 | 0.3687 | | 0.3551 | 0.3760 | | 0.3533 | 0.3620 |
| | 0.3440 | 0.3427 | | 0.3451 | 0.3554 | | 0.3533 | 0.3620 | | 0.3515 | 0.3487 |
| | 0.3366 | 0.3369 | | 0.3371 | 0.3490 | | 0.3451 | 0.3554 | | 0.3440 | 0.3427 |
| 3R | 0.3366 | 0.3369 | 3S | 0.3381 | 0.3762 | 3T | 0.3480 | 0.3840 | 3U | 0.3440 | 0.3428 |
| | 0.3440 | 0.3428 | | 0.3480 | 0.3840 | | 0.3571 | 0.3907 | | 0.3515 | 0.3487 |
| | 0.3429 | 0.3307 | | 0.3463 | 0.3687 | | 0.3551 | 0.3760 | | 0.3495 | 0.3339 |
| | 0.3361 | 0.3245 | | 0.3376 | 0.3616 | | 0.3463 | 0.3687 | | 0.3429 | 0.3307 |
| 4A | 0.3530 | 0.3597 | 4B | 0.3548 | 0.3736 | 4C | 0.3641 | 0.3804 | 4D | 0.3615 | 0.3659 |
| | 0.3615 | 0.3659 | | 0.3641 | 0.3804 | | 0.3736 | 0.3874 | | 0.3702 | 0.3722 |
| | 0.3590 | 0.3521 | | 0.3615 | 0.3659 | | 0.3702 | 0.3722 | | 0.3670 | 0.3578 |
| | 0.3512 | 0.3465 | | 0.3530 | 0.3597 | | 0.3615 | 0.3659 | | 0.3590 | 0.3521 |
| 4R | 0.3512 | 0.3465 | 4S | 0.3571 | 0.3907 | 4T | 0.3668 | 0.3957 | 4U | 0.3590 | 0.3521 |
| | 0.3590 | 0.3521 | | 0.3668 | 0.3957 | | 0.3771 | 0.4034 | | 0.3670 | 0.3578 |
| | 0.3567 | 0.3389 | | 0.3641 | 0.3804 | | 0.3736 | 0.3874 | | 0.3640 | 0.3440 |
| | 0.3495 | 0.3339 | | 0.3548 | 0.3736 | | 0.3641 | 0.3804 | | 0.3567 | 0.3389 |

PERFORMANCE GROUPS – CHROMATICITY (CONTINUED)

| Region | x | y | Region | x | y | Region | x | y | Region | x | y |
|--------|--------|--------|--------|--------|--------|--------|--------|--------|--------|--------|--------|
| 5A1 | 0.3670 | 0.3578 | 5A2 | 0.3686 | 0.3649 | 5A3 | 0.3744 | 0.3685 | 5A4 | 0.3726 | 0.3612 |
| | 0.3686 | 0.3649 | | 0.3702 | 0.3722 | | 0.3763 | 0.3760 | | 0.3744 | 0.3685 |
| | 0.3744 | 0.3685 | | 0.3763 | 0.3760 | | 0.3825 | 0.3798 | | 0.3804 | 0.3721 |
| | 0.3726 | 0.3612 | | 0.3744 | 0.3685 | | 0.3804 | 0.3721 | | 0.3783 | 0.3646 |
| 5B1 | 0.3702 | 0.3722 | 5B2 | 0.3719 | 0.3797 | 5B3 | 0.3782 | 0.3837 | 5B4 | 0.3763 | 0.3760 |
| | 0.3719 | 0.3797 | | 0.3736 | 0.3874 | | 0.3802 | 0.3916 | | 0.3782 | 0.3837 |
| | 0.3782 | 0.3837 | | 0.3802 | 0.3916 | | 0.3869 | 0.3958 | | 0.3847 | 0.3877 |
| | 0.3763 | 0.3760 | | 0.3782 | 0.3837 | | 0.3847 | 0.3877 | | 0.3825 | 0.3798 |
| 5C1 | 0.3825 | 0.3798 | 5C2 | 0.3847 | 0.3877 | 5C3 | 0.3912 | 0.3917 | 5C4 | 0.3887 | 0.3836 |
| | 0.3847 | 0.3877 | | 0.3869 | 0.3958 | | 0.3937 | 0.4001 | | 0.3912 | 0.3917 |
| | 0.3912 | 0.3917 | | 0.3937 | 0.4001 | | 0.4006 | 0.4044 | | 0.3978 | 0.3958 |
| | 0.3887 | 0.3836 | | 0.3912 | 0.3917 | | 0.3978 | 0.3958 | | 0.3950 | 0.3875 |
| 5D1 | 0.3783 | 0.3646 | 5D2 | 0.3804 | 0.3721 | 5D3 | 0.3863 | 0.3758 | 5D4 | 0.3840 | 0.3681 |
| | 0.3804 | 0.3721 | | 0.3825 | 0.3798 | | 0.3887 | 0.3836 | | 0.3863 | 0.3758 |
| | 0.3863 | 0.3758 | | 0.3887 | 0.3836 | | 0.3950 | 0.3875 | | 0.3924 | 0.3794 |
| | 0.3840 | 0.3681 | | 0.3863 | 0.3758 | | 0.3924 | 0.3794 | | 0.3898 | 0.3716 |
| 5R | 0.3670 | 0.3578 | 5S | 0.3771 | 0.4034 | 5T | 0.3916 | 0.4127 | 5U | 0.3783 | 0.3646 |
| | 0.3783 | 0.3646 | | 0.3916 | 0.4127 | | 0.4064 | 0.4221 | | 0.3898 | 0.3716 |
| | 0.3743 | 0.3502 | | 0.3869 | 0.3958 | | 0.4006 | 0.4044 | | 0.3848 | 0.3565 |
| | 0.3640 | 0.3440 | | 0.3736 | 0.3874 | | 0.3869 | 0.3958 | | 0.3743 | 0.3502 |
| 6A1 | 0.3889 | 0.3690 | 6A2 | 0.3915 | 0.3768 | 6A3 | 0.3981 | 0.3800 | 6A4 | 0.3953 | 0.3720 |
| | 0.3915 | 0.3768 | | 0.3941 | 0.3848 | | 0.4010 | 0.3882 | | 0.3981 | 0.3800 |
| | 0.3981 | 0.3800 | | 0.4010 | 0.3882 | | 0.4080 | 0.3916 | | 0.4048 | 0.3832 |
| | 0.3953 | 0.3720 | | 0.3981 | 0.3800 | | 0.4048 | 0.3832 | | 0.4017 | 0.3751 |
| 6B1 | 0.3941 | 0.3848 | 6B2 | 0.3968 | 0.3930 | 6B3 | 0.4040 | 0.3966 | 6B4 | 0.4010 | 0.3882 |
| | 0.3968 | 0.3930 | | 0.3996 | 0.4015 | | 0.4071 | 0.4052 | | 0.4040 | 0.3966 |
| | 0.4040 | 0.3966 | | 0.4071 | 0.4052 | | 0.4146 | 0.4089 | | 0.4113 | 0.4001 |
| | 0.4010 | 0.3882 | | 0.4040 | 0.3966 | | 0.4113 | 0.4001 | | 0.4080 | 0.3916 |
| 6C1 | 0.4080 | 0.3916 | 6C2 | 0.4113 | 0.4001 | 6C3 | 0.4186 | 0.4037 | 6C4 | 0.4150 | 0.3950 |
| | 0.4113 | 0.4001 | | 0.4146 | 0.4089 | | 0.4222 | 0.4127 | | 0.4186 | 0.4037 |
| | 0.4186 | 0.4037 | | 0.4222 | 0.4127 | | 0.4299 | 0.4165 | | 0.4259 | 0.4073 |
| | 0.4150 | 0.3950 | | 0.4186 | 0.4037 | | 0.4259 | 0.4073 | | 0.4221 | 0.3984 |
| 6D1 | 0.4017 | 0.3751 | 6D2 | 0.4048 | 0.3832 | 6D3 | 0.4116 | 0.3865 | 6D4 | 0.4082 | 0.3782 |
| | 0.4048 | 0.3832 | | 0.4080 | 0.3916 | | 0.4150 | 0.3950 | | 0.4116 | 0.3865 |
| | 0.4116 | 0.3865 | | 0.4150 | 0.3950 | | 0.4221 | 0.3984 | | 0.4183 | 0.3898 |
| | 0.4082 | 0.3782 | | 0.4116 | 0.3865 | | 0.4183 | 0.3898 | | 0.4147 | 0.3814 |
| 6R | 0.3889 | 0.3690 | 6S | 0.4054 | 0.4191 | 6T | 0.4217 | 0.4273 | 6U | 0.4017 | 0.3751 |
| | 0.4017 | 0.3751 | | 0.4217 | 0.4273 | | 0.4382 | 0.4356 | | 0.4147 | 0.3814 |
| | 0.3957 | 0.3596 | | 0.4146 | 0.4089 | | 0.4299 | 0.4165 | | 0.4077 | 0.3652 |
| | 0.3840 | 0.3540 | | 0.3996 | 0.4015 | | 0.4146 | 0.4089 | | 0.3957 | 0.3596 |

PERFORMANCE GROUPS – CHROMATICITY (CONTINUED)

| Region | x | y | Region | x | y | Region | x | y | Region | x | y |
|--------|--------|--------|--------|--------|--------|--------|--------|--------|--------|--------|--------|
| 7A1 | 0.4147 | 0.3814 | 7A2 | 0.4183 | 0.3898 | 7A3 | 0.4242 | 0.3919 | 7A4 | 0.4203 | 0.3833 |
| | 0.4183 | 0.3898 | | 0.4221 | 0.3984 | | 0.4281 | 0.4006 | | 0.4242 | 0.3919 |
| | 0.4242 | 0.3919 | | 0.4281 | 0.4006 | | 0.4342 | 0.4028 | | 0.4300 | 0.3939 |
| | 0.4203 | 0.3833 | | 0.4242 | 0.3919 | | 0.4300 | 0.3939 | | 0.4259 | 0.3853 |
| 7B1 | 0.4221 | 0.3984 | 7B2 | 0.4259 | 0.4073 | 7B3 | 0.4322 | 0.4096 | 7B4 | 0.4281 | 0.4006 |
| | 0.4259 | 0.4073 | | 0.4299 | 0.4165 | | 0.4364 | 0.4188 | | 0.4322 | 0.4096 |
| | 0.4322 | 0.4096 | | 0.4364 | 0.4188 | | 0.4430 | 0.4212 | | 0.4385 | 0.4119 |
| | 0.4281 | 0.4006 | | 0.4322 | 0.4096 | | 0.4385 | 0.4119 | | 0.4342 | 0.4028 |
| 7C1 | 0.4342 | 0.4028 | 7C2 | 0.4385 | 0.4119 | 7C3 | 0.4449 | 0.4141 | 7C4 | 0.4403 | 0.4049 |
| | 0.4385 | 0.4119 | | 0.4430 | 0.4212 | | 0.4496 | 0.4236 | | 0.4449 | 0.4141 |
| | 0.4449 | 0.4141 | | 0.4496 | 0.4236 | | 0.4562 | 0.4260 | | 0.4513 | 0.4164 |
| | 0.4403 | 0.4049 | | 0.4449 | 0.4141 | | 0.4513 | 0.4164 | | 0.4465 | 0.4071 |
| 7D1 | 0.4259 | 0.3853 | 7D2 | 0.4300 | 0.3939 | 7D3 | 0.4359 | 0.3960 | 7D4 | 0.4316 | 0.3873 |
| | 0.4300 | 0.3939 | | 0.4342 | 0.4028 | | 0.4403 | 0.4049 | | 0.4359 | 0.3960 |
| | 0.4359 | 0.3960 | | 0.4403 | 0.4049 | | 0.4465 | 0.4071 | | 0.4418 | 0.3981 |
| | 0.4316 | 0.3873 | | 0.4359 | 0.3960 | | 0.4418 | 0.3981 | | 0.4373 | 0.3893 |
| 8A1 | 0.4373 | 0.3893 | 8A2 | 0.4418 | 0.3981 | 8A3 | 0.4475 | 0.3994 | 8A4 | 0.4428 | 0.3906 |
| | 0.4418 | 0.3981 | | 0.4465 | 0.4071 | | 0.4523 | 0.4085 | | 0.4475 | 0.3994 |
| | 0.4475 | 0.3994 | | 0.4523 | 0.4085 | | 0.4582 | 0.4099 | | 0.4532 | 0.4008 |
| | 0.4428 | 0.3906 | | 0.4475 | 0.3994 | | 0.4532 | 0.4008 | | 0.4483 | 0.3919 |
| 8B1 | 0.4465 | 0.4071 | 8B2 | 0.4513 | 0.4164 | 8B3 | 0.4573 | 0.4178 | 8B4 | 0.4523 | 0.4085 |
| | 0.4513 | 0.4164 | | 0.4562 | 0.4260 | | 0.4624 | 0.4274 | | 0.4573 | 0.4178 |
| | 0.4573 | 0.4178 | | 0.4624 | 0.4274 | | 0.4687 | 0.4289 | | 0.4634 | 0.4193 |
| | 0.4523 | 0.4085 | | 0.4573 | 0.4178 | | 0.4634 | 0.4193 | | 0.4582 | 0.4099 |
| 8C1 | 0.4582 | 0.4099 | 8C2 | 0.4634 | 0.4193 | 8C3 | 0.4695 | 0.4207 | 8C4 | 0.4641 | 0.4112 |
| | 0.4634 | 0.4193 | | 0.4687 | 0.4289 | | 0.4750 | 0.4304 | | 0.4695 | 0.4207 |
| | 0.4695 | 0.4207 | | 0.4750 | 0.4304 | | 0.4813 | 0.4319 | | 0.4756 | 0.4221 |
| | 0.4641 | 0.4112 | | 0.4695 | 0.4207 | | 0.4756 | 0.4221 | | 0.4700 | 0.4126 |
| 8D1 | 0.4483 | 0.3919 | 8D2 | 0.4532 | 0.4008 | 8D3 | 0.4589 | 0.4021 | 8D4 | 0.4538 | 0.3931 |
| | 0.4532 | 0.4008 | | 0.4582 | 0.4099 | | 0.4641 | 0.4112 | | 0.4589 | 0.4021 |
| | 0.4589 | 0.4021 | | 0.4641 | 0.4112 | | 0.4700 | 0.4126 | | 0.4646 | 0.4034 |
| | 0.4538 | 0.3931 | | 0.4589 | 0.4021 | | 0.4646 | 0.4034 | | 0.4593 | 0.3944 |
| AA1 | 0.4822 | 0.3973 | AA2 | 0.4884 | 0.4067 | AA3 | 0.4942 | 0.4066 | AA4 | 0.4879 | 0.3972 |
| | 0.4884 | 0.4067 | | 0.4946 | 0.4162 | | 0.5006 | 0.4160 | | 0.4942 | 0.4066 |
| | 0.4942 | 0.4066 | | 0.5006 | 0.4160 | | 0.5066 | 0.4158 | | 0.5001 | 0.4064 |
| | 0.4879 | 0.3972 | | 0.4942 | 0.4066 | | 0.5001 | 0.4064 | | 0.4936 | 0.3970 |
| AB1 | 0.4946 | 0.4162 | AB2 | 0.5008 | 0.4256 | AB3 | 0.5069 | 0.4254 | AB4 | 0.5006 | 0.4160 |
| | 0.5008 | 0.4256 | | 0.5070 | 0.4350 | | 0.5133 | 0.4348 | | 0.5069 | 0.4254 |
| | 0.5069 | 0.4254 | | 0.5133 | 0.4348 | | 0.5196 | 0.4346 | | 0.5131 | 0.4252 |
| | 0.5006 | 0.4160 | | 0.5069 | 0.4254 | | 0.5131 | 0.4252 | | 0.5066 | 0.4158 |

PERFORMANCE GROUPS – CHROMATICITY (CONTINUED)

| Region | x | y | Region | x | y | Region | x | y | Region | x | y |
|--------|--------|--------|--------|--------|--------|--------|--------|--------|--------|--------|--------|
| AC1 | 0.5066 | 0.4158 | AC2 | 0.5131 | 0.4252 | AC3 | 0.5192 | 0.4250 | AC4 | 0.5126 | 0.4156 |
| | 0.5131 | 0.4252 | | 0.5196 | 0.4346 | | 0.5258 | 0.4343 | | 0.5192 | 0.4250 |
| | 0.5192 | 0.4250 | | 0.5258 | 0.4343 | | 0.5321 | 0.4341 | | 0.5253 | 0.4248 |
| | 0.5126 | 0.4156 | | 0.5192 | 0.4250 | | 0.5253 | 0.4248 | | 0.5186 | 0.4154 |
| AD1 | 0.4936 | 0.3970 | AD2 | 0.5001 | 0.4064 | AD3 | 0.5059 | 0.4062 | AD4 | 0.4993 | 0.3969 |
| | 0.5001 | 0.4064 | | 0.5066 | 0.4158 | | 0.5126 | 0.4156 | | 0.5059 | 0.4062 |
| | 0.5059 | 0.4062 | | 0.5126 | 0.4156 | | 0.5186 | 0.4154 | | 0.5118 | 0.4061 |
| | 0.4993 | 0.3969 | | 0.5059 | 0.4062 | | 0.5118 | 0.4061 | | 0.5050 | 0.3967 |

XLamp XP-E2 PC amber LEDs are placed into the region defined by the following bounding coordinates.

| Region | x | y |
|--------|--------|--------|
| Y2 | 0.5469 | 0.4249 |
| | 0.5700 | 0.4100 |
| | 0.5900 | 0.4100 |
| | 0.5610 | 0.4390 |

PERFORMANCE GROUPS – DOMINANT WAVELENGTH

Color XLamp LEDs are tested for dominant wavelength (DWL) and sorted into one of the DWL bins defined below.

| Color | DWL Group | Min. DWL (nm) @ 350 mA | Max. DWL (nm) @ 350 mA |
|------------|-----------|---------------------------|---------------------------|
| Royal Blue | D3 | 450 | 455 |
| | D4 | 455 | 460 |
| | D5 | 460 | 465 |
| Blue | B3 | 465 | 470 |
| | B4 | 470 | 475 |
| | B5 | 475 | 480 |
| | B6 | 480 | 485 |
| Green | G2 | 520 | 525 |
| | G3 | 525 | 530 |
| | G4 | 530 | 535 |
| Amber | A2 | 585 | 590 |
| | A3 | 590 | 595 |
| Red-Orange | O3 | 610 | 615 |
| | O4 | 615 | 620 |
| Red | R2 | 620 | 625 |
| | R3 | 625 | 630 |

PERFORMANCE GROUPS – FORWARD VOLTAGE

Amber, red-orange, red and High-Efficiency White XLamp LEDs are tested for forward voltage and sorted into one of the forward voltage bins defined below.

| Forward Voltage Group | Min. Forward Voltage @ 350 mA | Max. Forward Voltage @ 350 mA |
|-----------------------|----------------------------------|----------------------------------|
| B | 1.75 | 2.0 |
| C | 2.0 | 2.25 |
| D | 2.25 | 2.5 |
| E | 2.5 | 2.75 |
| F | 2.75 | 3.0 |
| G | 3.0 | 3.25 |
| H | 3.25 | 3.5 |
| J | 3.5 | 3.75 |

CREE'S STANDARD CHROMATICITY REGIONS PLOTTED ON THE 1931 CIE CURVE

Cool White

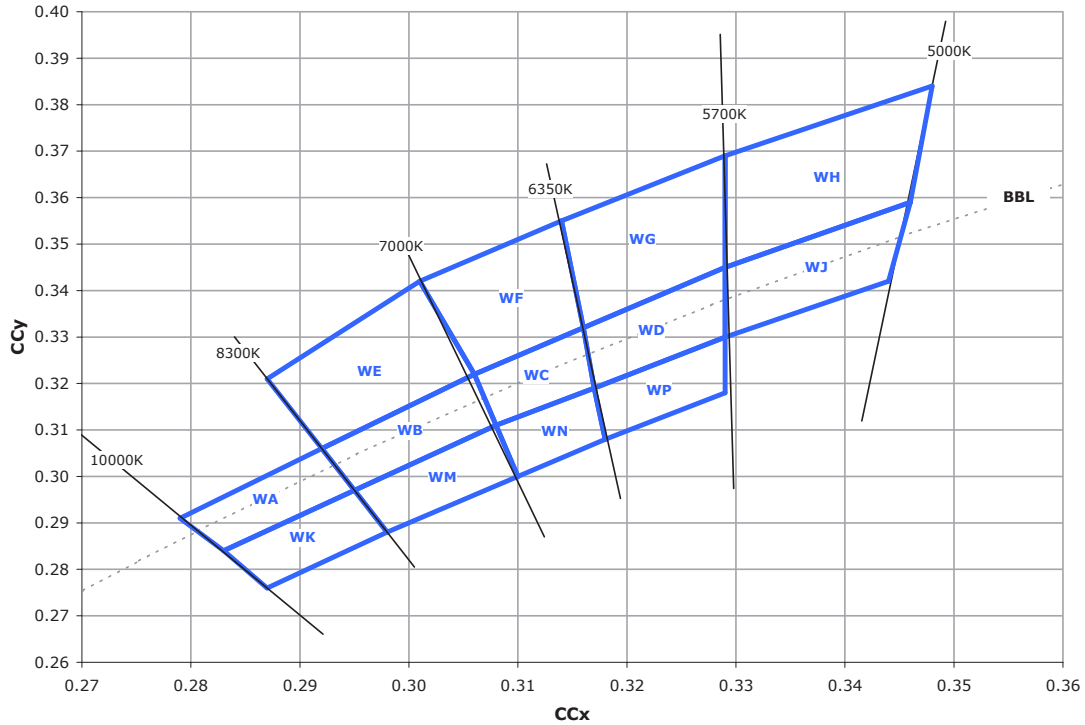

ANSI Cool White

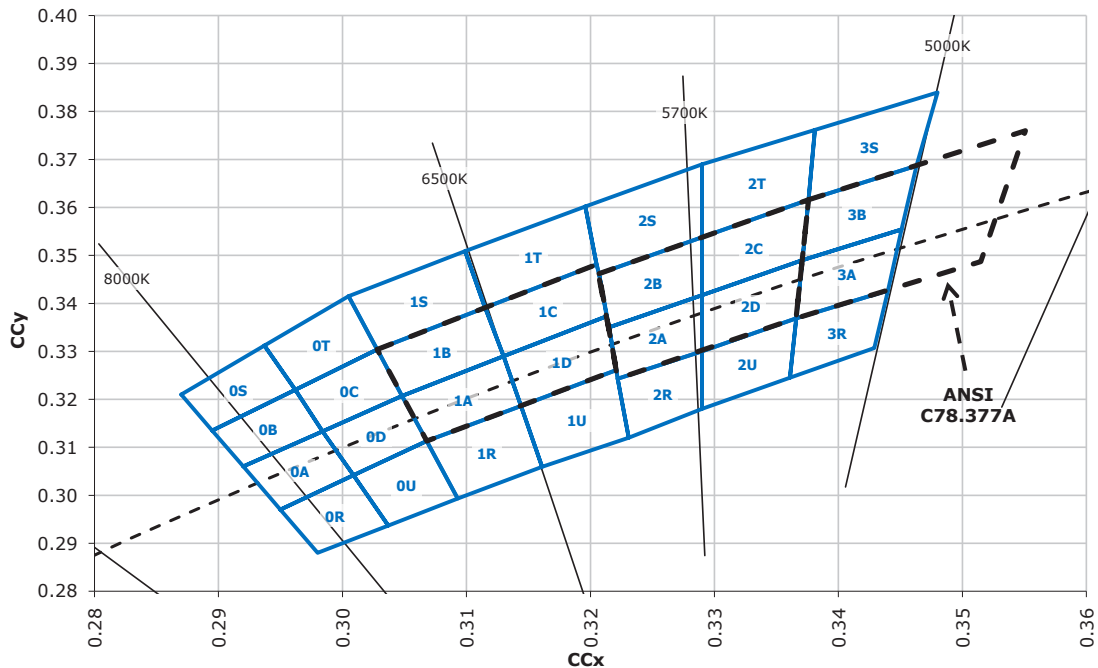

CREE'S STANDARD CHROMATICITY REGIONS PLOTTED ON THE 1931 CIE CURVE (CONTINUED)

Neutral White

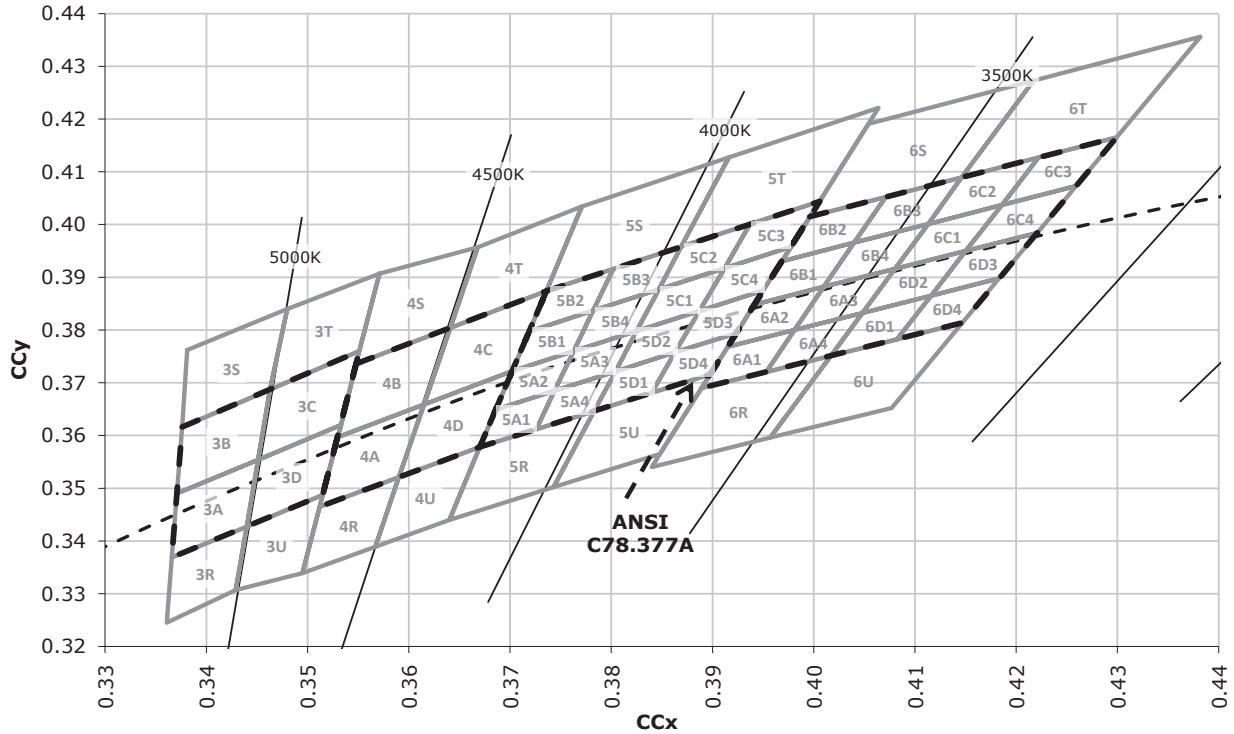

ANSI Neutral White and ANSI Warm White

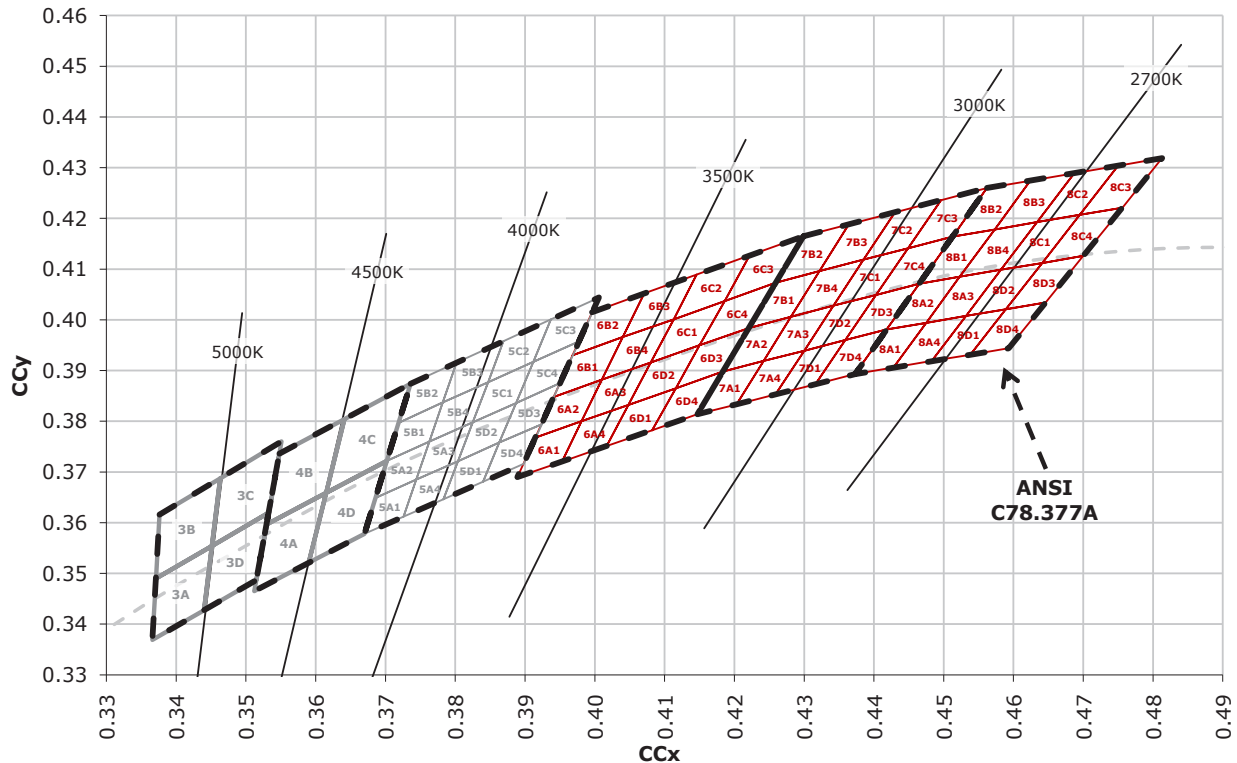

CREE'S STANDARD COOL WHITE KITS PLOTTED ON ANSI STANDARD CHROMATICITY REGIONS

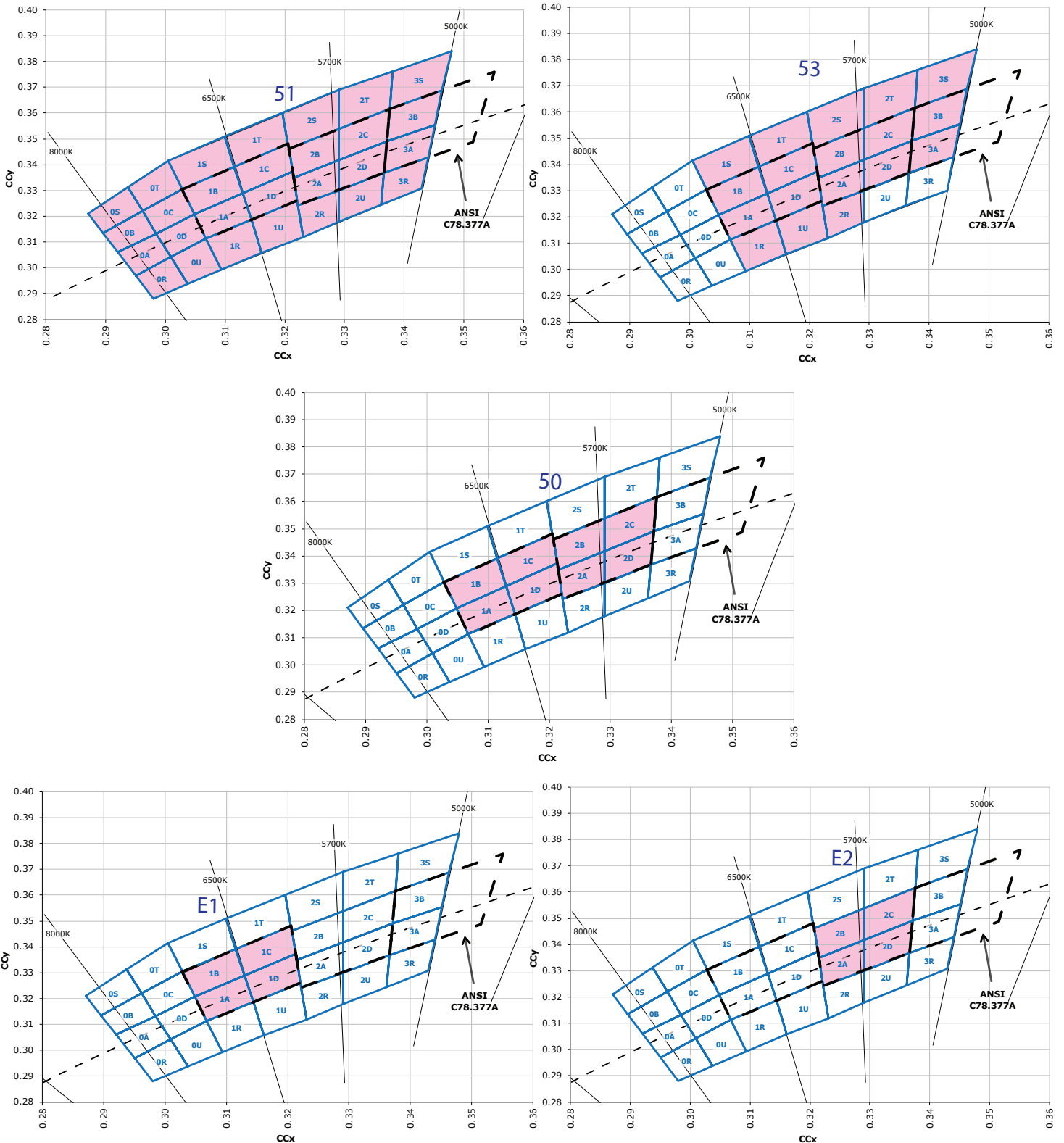

CREE'S OUTDOOR WHITE KITS PLOTTED ON ANSI STANDARD CHROMATICITY REGIONS

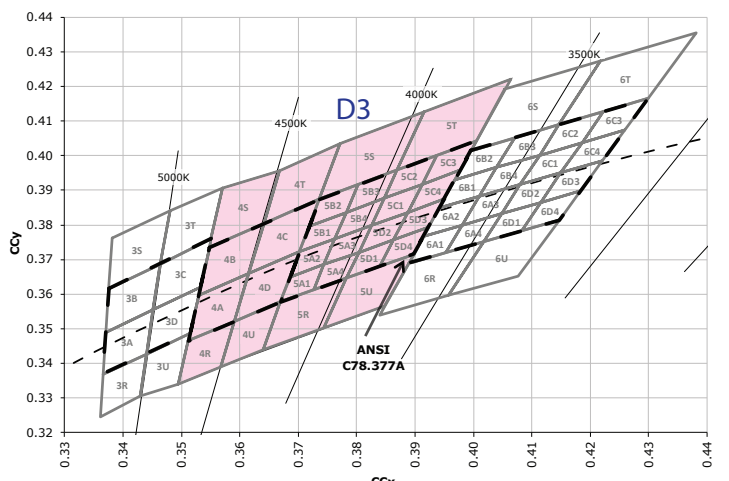
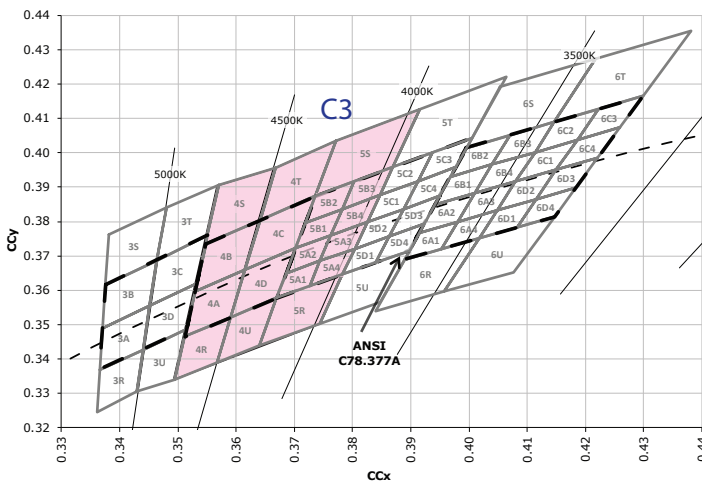
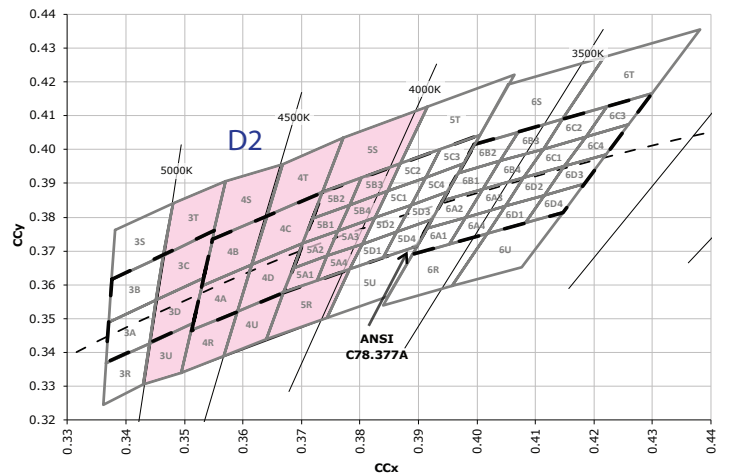
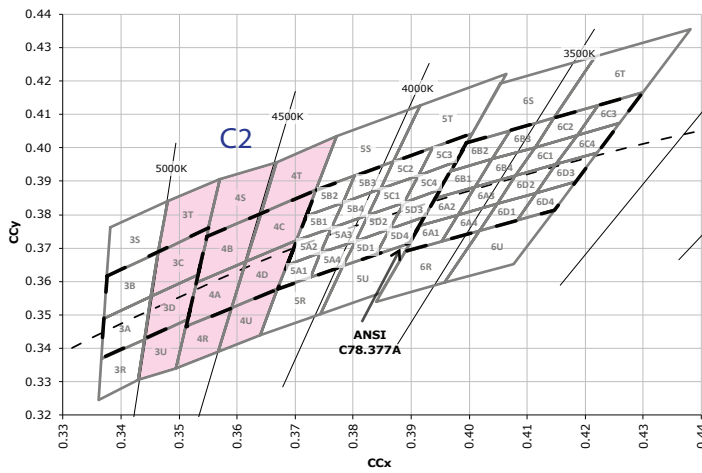
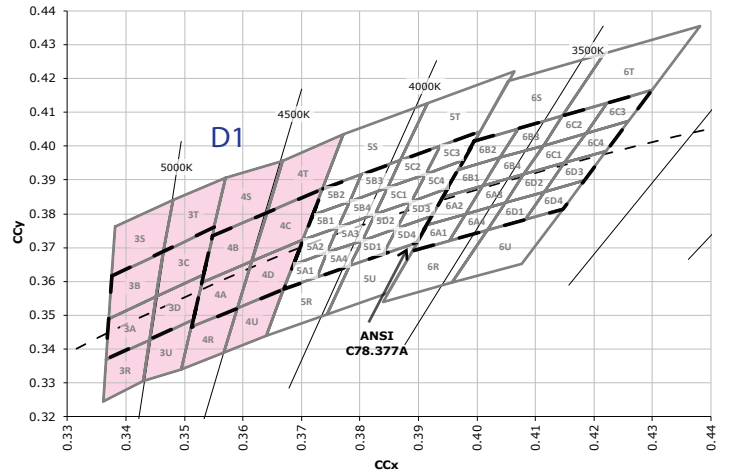
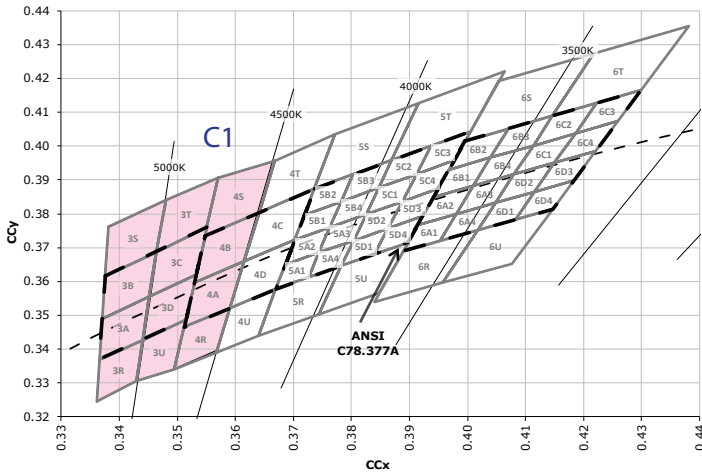

CREE'S OUTDOOR WHITE KITS PLOTTED ON ANSI STANDARD CHROMATICITY REGIONS (CONTINUED)

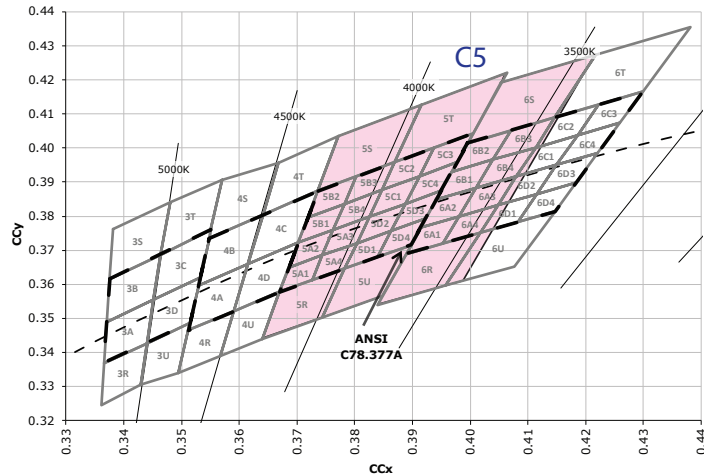
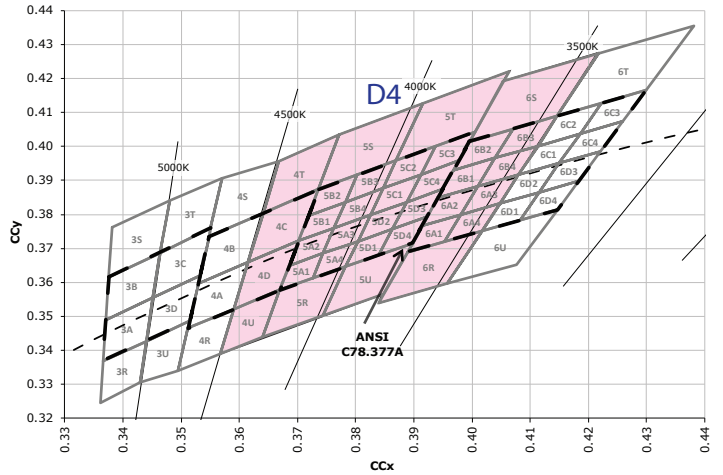
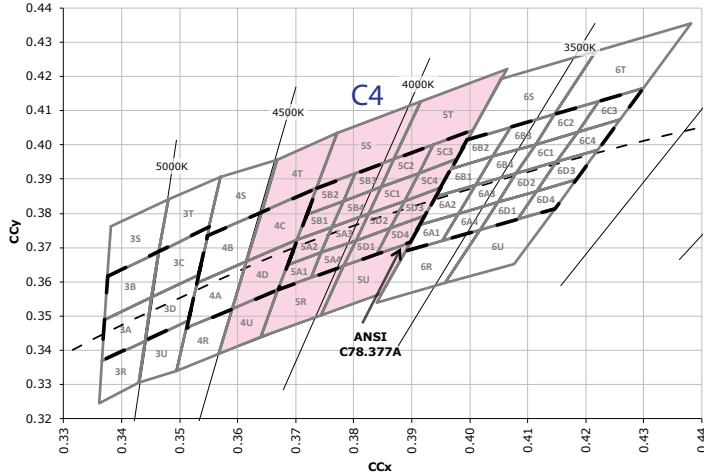

CREE'S STANDARD WARM AND NEUTRAL WHITE KITS PLOTTED ON ANSI STANDARD CHROMATICITY REGIONS

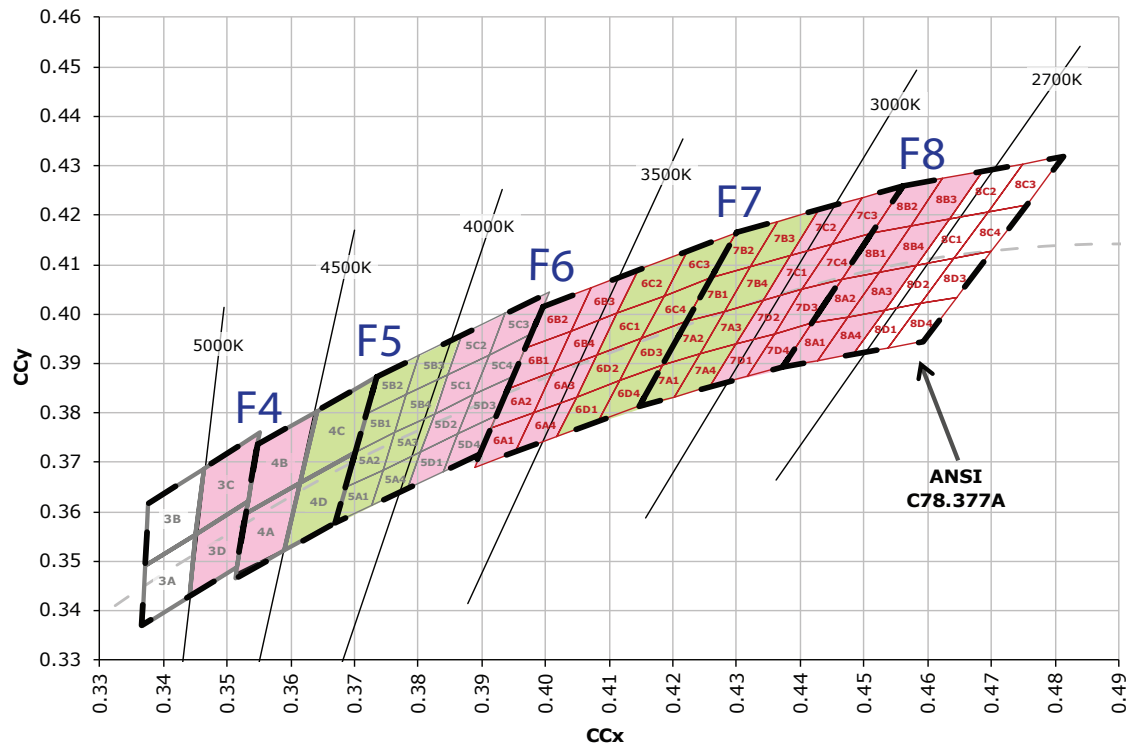
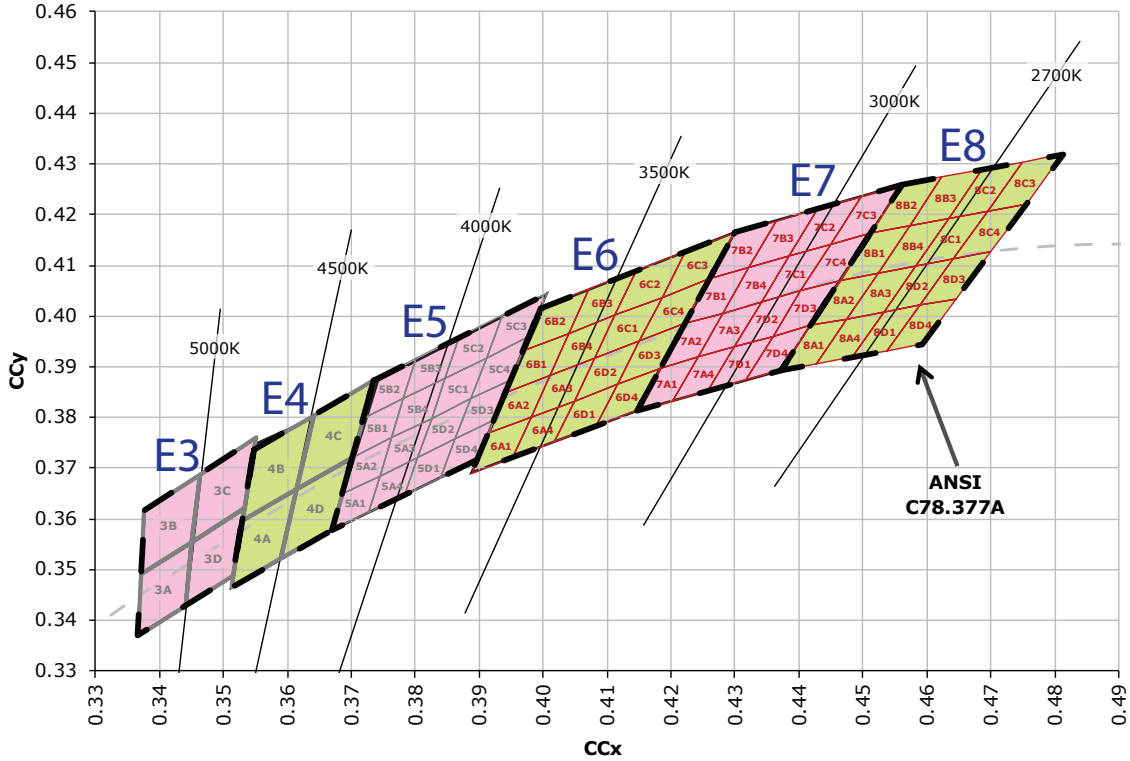

CREE'S STANDARD WARM AND NEUTRAL WHITE KITS PLOTTED ON ANSI STANDARD CHROMATICITY REGIONS (CONTINUED)

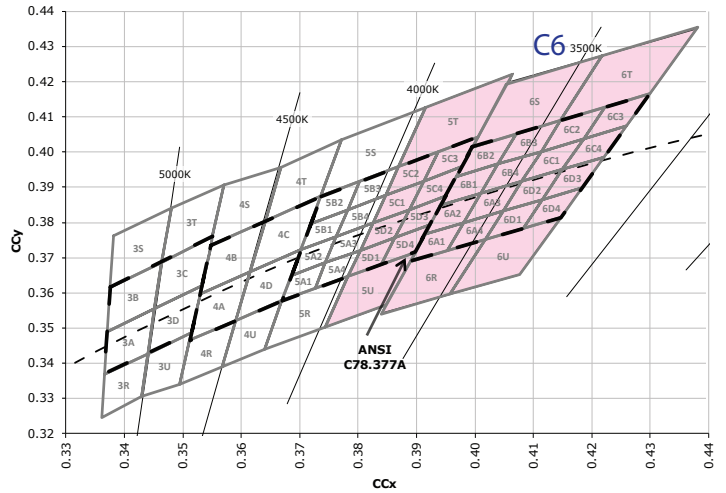
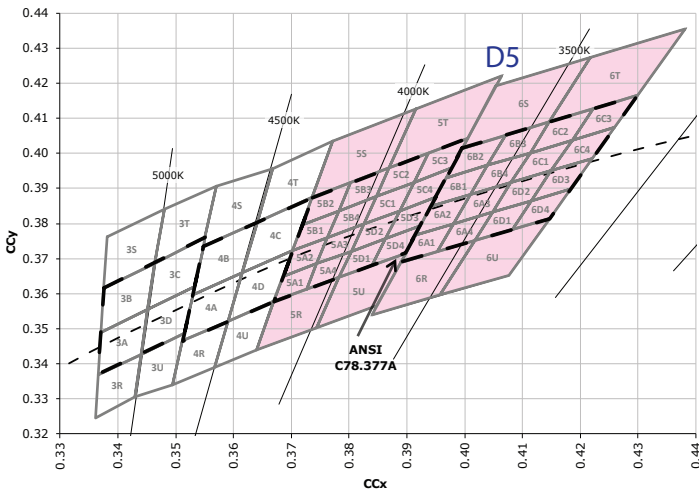
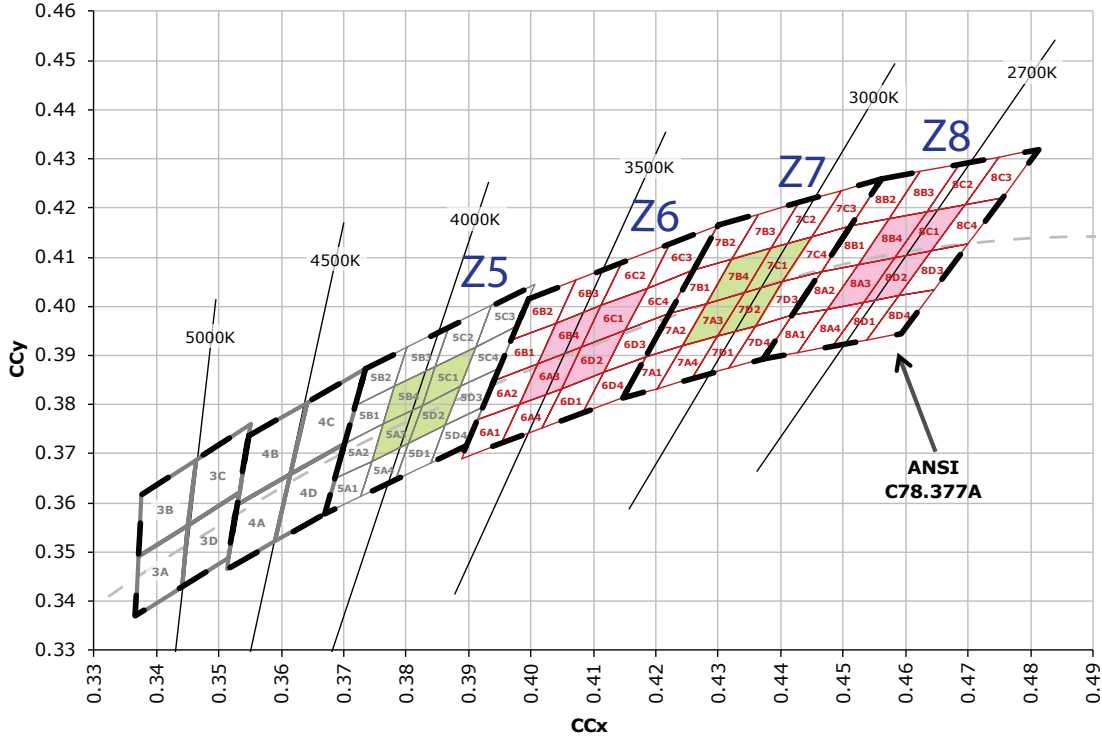

CREE'S 2200 K CCT WHITE KITS PLOTTED ON ANSI STANDARD CHROMATICITY REGIONS

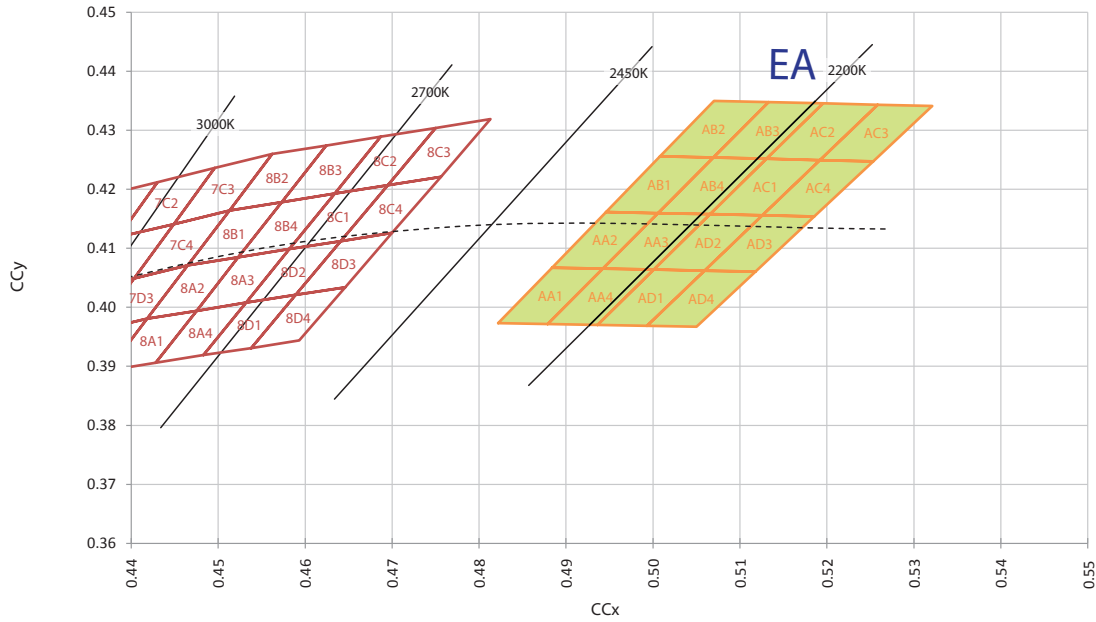

CREE'S PC AMBER KIT PLOTTED ON THE 1931 CIE CURVE

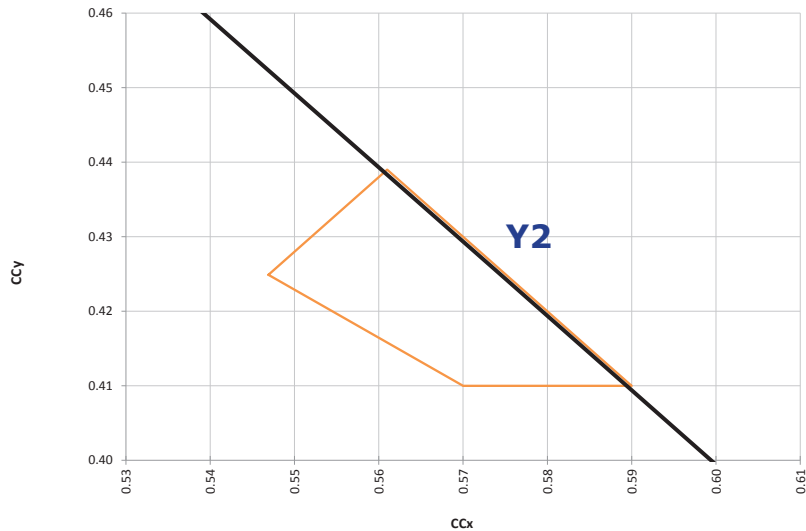

CREE'S STANDARD CHROMATICITY KITS

The following table provides the chromaticity bins associated with chromaticity kits.

| Color | CCT | Kit | Chromaticity Bins |
|---------------|--------|--|--|
| Cool White | 6200 K | S1 | 0A, 0B, 0C, 0D, 0R, 0S, 0T, 0U, 1A, 1B, 1C, 1D, 1R, 1S, 1T, 1U, 2A, 2B, 2C, 2D, 2R, 2S, 2T, 2U, 3A, 3B, 3R, 3S |
| | 6000 K | S3 | 1A, 1B, 1C, 1D, 1R, 1S, 1T, 1U, 2A, 2B, 2C, 2D, 2R, 2S, 2T, 3A, 3B, 3S |
| | 6200 K | S0 | 1A, 1B, 1C, 1D, 2A, 2B, 2C, 2D |
| | 6500 K | E1 | 1A, 1B, 1C, 1D |
| | 5700 K | E2 | 2A, 2B, 2C, 2D |
| Neutral White | 5000 K | E3 | 3A, 3B, 3C, 3D |
| | 5000 K | C1 | 3A, 3B, 3C, 3D, 3R, 3S, 3T, 3U, 4A, 4B, 4R, 4S |
| | 4750 K | F4 | 3C, 3D, 4A, 4B |
| | 4750 K | D1 | 3A, 3B, 3C, 3D, 3R, 3S, 3T, 3U, 4A, 4B, 4C, 4D, 4R, 4S, 4T, 4U |
| | 4500 K | E4 | 4A, 4B, 4C, 4D |
| | 4500 K | D2 | 3C, 3D, 3T, 3U, 4A, 4B, 4C, 4D, 4R, 4S, 4T, 4U, 5A1, 5A2, 5A3, 5A4, 5B1, 5B2, 5B3, 5B4, 5R, 5S |
| | 4500 K | C2 | 3C, 3D, 3T, 3U, 4A, 4B, 4C, 4D, 4R, 4S, 4T, 4U |
| | 4300 K | C3 | 4A, 4B, 4C, 4D, 4R, 4S, 4T, 4U, 5A1, 5A2, 5A3, 5A4, 5B1, 5B2, 5B3, 5B4, 5R, 5S |
| | 4300 K | D3 | 4A, 4B, 4C, 4D, 4R, 4S, 4T, 4U, 5A1, 5A2, 5A3, 5A4, 5B1, 5B2, 5B3, 5B4, 5C1, 5C2, 5C3, 5C4, 5D1, 5D2, 5D3, 5D4, 5R, 5S, 5T, 5U |
| | 4250 K | F5 | 4C, 4D, 5A1, 5A2, 5A3, 5A4, 5B1, 5B2, 5B3, 5B4 |
| | 4100 K | C4 | 4C, 4D, 4T, 4U, 5A1, 5A2, 5A3, 5A4, 5B1, 5B2, 5B3, 5B4, 5C1, 5C2, 5C3, 5C4, 5D1, 5D2, 5D3, 5D4, 5R, 5S, 5T, 5U |
| | 4000 K | D4 | 4C, 4D, 4T, 4U, 5A1, 5A2, 5A3, 5A4, 5B1, 5B2, 5B3, 5B4, 5C1, 5C2, 5C3, 5C4, 5D1, 5D2, 5D3, 5D4, 5R, 5S, 5T, 5U, 6A1, 6A2, 6A3, 6A4, 6B1, 6B2, 6B3, 6B4, 6R, 6S |
| | 4000 K | E5 | 5A1, 5A2, 5A3, 5A4, 5B1, 5B2, 5B3, 5B4, 5C1, 5C2, 5C3, 5C4, 5D1, 5D2, 5D3, 5D4 |
| | 4000 K | Z5 | 5A3, 5B4, 5C1, 5D2 |
| 3800 K | C5 | 5A1, 5A2, 5A3, 5A4, 5B1, 5B2, 5B3, 5B4, 5C1, 5C2, 5C3, 5C4, 5D1, 5D2, 5D3, 5D4, 5R, 5S, 5T, 5U, 6A1, 6A2, 6A3, 6A4, 6B1, 6B2, 6B3, 6B4, 6R, 6S | |
| Warm White | 3750 K | F6 | 5C1, 5C2, 5C3, 5C4, 5D1, 5D2, 5D3, 5D4, 6A1, 6A2, 6A3, 6A4, 6B1, 6B2, 6B3, 6B4 |
| | 3700 K | D5 | 5A1, 5A2, 5A3, 5A4, 5B1, 5B2, 5B3, 5B4, 5C1, 5C2, 5C3, 5C4, 5D1, 5D2, 5D3, 5D4, 5R, 5S, 5T, 5U, 6A1, 6A2, 6A3, 6A4, 6B1, 6B2, 6B3, 6B4, 6C1, 6C2, 6C3, 6C4, 6D1, 6D2, 6D3, 6D4, 6R, 6S, 6T, 6U |
| | 3600 K | C6 | 5C1, 5C2, 5C3, 5C4, 5D1, 5D2, 5D3, 5D4, 5T, 5U, 6A1, 6A2, 6A3, 6A4, 6B1, 6B2, 6B3, 6B4, 6C1, 6C2, 6C3, 6C4, 6D1, 6D2, 6D3, 6D4, 6R, 6S, 6T, 6U |
| | 3500 K | E6 | 6A1, 6A2, 6A3, 6A4, 6B1, 6B2, 6B3, 6B4, 6C1, 6C2, 6C3, 6C4, 6D1, 6D2, 6D3, 6D4 |
| | 3500 K | Z6 | 6A3, 6B4, 6C1, 6D2 |
| | 3250 K | F7 | 6C1, 6C2, 6C3, 6C4, 6D1, 6D2, 6D3, 6D4, 7A1, 7A2, 7A3, 7A4, 7B1, 7B2, 7B3, 7B4 |
| | 3000 K | E7 | 7A1, 7A2, 7A3, 7A4, 7B1, 7B2, 7B3, 7B4, 7C1, 7C2, 7C3, 7C4, 7D1, 7D2, 7D3, 7D4 |
| | 3000 K | Z7 | 7A3, 7B4, 7C1, 7D2 |
| | 2850 K | F8 | 7C1, 7C2, 7C3, 7C4, 7D1, 7D2, 7D3, 7D4, 8A1, 8A2, 8A3, 8A4, 8B1, 8B2, 8B3, 8B4 |
| | 2700 K | E8 | 8A1, 8A2, 8A3, 8A4, 8B1, 8B2, 8B3, 8B4, 8C1, 8C2, 8C3, 8C4, 8D1, 8D2, 8D3, 8D4 |
| | 2700 K | Z8 | 8A3, 8B4, 8C1, 8D2 |
| 2200 K | EA | AA1, AA2, AA3, AA4, AB1, AB2, AB3, AB4, AC1, AC2, AC3, AC4, AD1, AD2, AD3, AD4 | |

The following tables of order codes list flux minimums and chromaticity regions for the various categories of XLamp XP LEDs. For other flux and chromaticity combinations, contact Cree or an authorized distributor.

STANDARD ORDER CODES AND PRE-ANSI BINS (XP-C COOL WHITE, T_j = 25 °C)

| XLamp XP-C LED Standard Order Codes - White | | | | |
|---|-----------|--|--|----------------------|
| Min. Luminous Flux (lm) @ 350 mA* | | Chromaticity Regions | | Order Codes |
| Group | Flux (lm) | | | |
| Cool White (5000 K – 10,000 K) | | | | |
| Q2 | 87.4 | WA, WB, WC, WD, WE, WF, WG, WH, WJ, WK, WM, WN, WP | | XPCWHT-L1-0000-00A01 |
| | | WC, WD, WF, WG | | XPCWHT-L1-0000-00A02 |
| | | WC, WD, WF, WG, WH, WJ, WN, WP | | XPCWHT-L1-0000-00A03 |
| Q3 | 93.9 | WA, WB, WC, WD, WE, WF, WG, WH, WJ, WK, WM, WN, WP | | XPCWHT-L1-0000-00B01 |
| | | WC, WD, WF, WG | | XPCWHT-L1-0000-00B02 |
| | | WC, WD, WF, WG, WH, WJ, WN, WP | | XPCWHT-L1-0000-00B03 |
| Q4 | 100 | WA, WB, WC, WD, WE, WF, WG, WH, WJ, WK, WM, WN, WP | | XPCWHT-L1-0000-00C01 |
| | | WC, WD, WF, WG | | XPCWHT-L1-0000-00C02 |
| | | WC, WD, WF, WG, WH, WJ, WN, WP | | XPCWHT-L1-0000-00C03 |
| Q5 | 107 | WA, WB, WC, WD, WE, WF, WG, WH, WJ, WK, WM, WN, WP | | XPCWHT-L1-0000-00D01 |
| | | WC, WD, WF, WG | | XPCWHT-L1-0000-00D02 |
| | | WC, WD, WF, WG, WH, WJ, WN, WP | | XPCWHT-L1-0000-00D03 |

STANDARD ORDER CODES AND BINS (XP-C ANSI COOL WHITE, T_j = 25 °C)

| XLamp XP-C LED Standard Order Codes - White | | | | |
|---|--------|--------------------------------------|-----------|----------------------|
| Chromaticity | | Minimum Luminous Flux (lm) @ 350 mA* | | Order Codes |
| Kit | CCT | Code | Flux (lm) | 70 CRI Typical |
| ANSI Cool White (5000 K – 8300 K) | | | | |
| 51 | 6200 K | Q5 | 107 | XPCWHT-L1-0000-00D51 |
| | | Q4 | 100 | XPCWHT-L1-0000-00C51 |
| | | Q3 | 93.9 | XPCWHT-L1-0000-00B51 |
| | | Q2 | 87.4 | XPCWHT-L1-0000-00A51 |
| 53 | 6000 K | Q5 | 107 | XPCWHT-L1-0000-00D53 |
| | | Q4 | 100 | XPCWHT-L1-0000-00C53 |
| | | Q3 | 93.9 | XPCWHT-L1-0000-00B53 |
| | | Q2 | 87.4 | XPCWHT-L1-0000-00A53 |
| 50 | 6200 K | Q5 | 107 | XPCWHT-L1-0000-00D50 |
| | | Q4 | 100 | XPCWHT-L1-0000-00C50 |
| | | Q3 | 93.9 | XPCWHT-L1-0000-00B50 |
| | | Q2 | 87.4 | XPCWHT-L1-0000-00A50 |
| E1 | 6500 K | Q5 | 107 | XPCWHT-L1-0000-00DE1 |
| | | Q4 | 100 | XPCWHT-L1-0000-00CE1 |
| | | Q3 | 93.9 | XPCWHT-L1-0000-00BE1 |
| | | Q2 | 87.4 | XPCWHT-L1-0000-00AE1 |
| E2 | 5700 K | Q5 | 107 | XPCWHT-L1-0000-00DE2 |
| | | Q4 | 100 | XPCWHT-L1-0000-00CE2 |
| | | Q3 | 93.9 | XPCWHT-L1-0000-00BE2 |
| | | Q2 | 87.4 | XPCWHT-L1-0000-00AE2 |

* Cree XLamp XP Family LED order codes specify only a minimum flux bin and not a maximum. Cree may ship reels in flux bins higher than the minimum specified by the order code without advance notice. Shipments will always adhere to the chromaticity or DWL bin restrictions specified by the order code.

STANDARD ORDER CODES AND BINS (XP-C NEUTRAL WHITE, T_j = 25 °C)

| XLamp XP-C LED Standard Kit Codes - White | | | | |
|---|--------|--------------------------------------|-----------|----------------------|
| Chromaticity | | Minimum Luminous Flux (lm) @ 350 mA* | | Order Codes |
| Kit | CCT | Code | Flux (lm) | 75 CRI Typical |
| ANSI Neutral White (3700 K – 5000 K) | | | | |
| E3 | 5000 K | Q2 | 87.4 | XPCWHT-L1-0000-00AE3 |
| | | P4 | 80.6 | XPCWHT-L1-0000-009E3 |
| | | P3 | 73.9 | XPCWHT-L1-0000-008E3 |
| F4 | 4750 K | Q2 | 87.4 | XPCWHT-L1-0000-00AF4 |
| | | P4 | 80.6 | XPCWHT-L1-0000-009F4 |
| | | P3 | 73.9 | XPCWHT-L1-0000-008F4 |
| E4 | 4500 K | Q2 | 87.4 | XPCWHT-L1-0000-00AE4 |
| | | P4 | 80.6 | XPCWHT-L1-0000-009E4 |
| | | P3 | 73.9 | XPCWHT-L1-0000-008E4 |
| F5 | 4250 K | Q2 | 87.4 | XPCWHT-L1-0000-00AF5 |
| | | P4 | 80.6 | XPCWHT-L1-0000-009F5 |
| | | P3 | 73.9 | XPCWHT-L1-0000-008F5 |
| | | P2 | 67.2 | XPCWHT-L1-0000-007F5 |
| E5 | 4000 K | Q2 | 87.4 | XPCWHT-L1-0000-00AE5 |
| | | P4 | 80.6 | XPCWHT-L1-0000-009E5 |
| | | P3 | 73.9 | XPCWHT-L1-0000-008E5 |
| | | P2 | 67.2 | XPCWHT-L1-0000-007E5 |

* Cree XLamp XP Family LED order codes specify only a minimum flux bin and not a maximum. Cree may ship reels in flux bins higher than the minimum specified by the order code without advance notice. Shipments will always adhere to the chromaticity or DWL bin restrictions specified by the order code.

STANDARD ORDER CODES AND BINS (XP-C WARM WHITE, $T_j = 25\text{ }^\circ\text{C}$)

| XLamp XP-C LED Standard Kit Codes - White | | | | |
|---|--------|--------------------------------------|-----------|----------------------|
| Chromaticity | | Minimum Luminous Flux (lm) @ 350 mA* | | Order Codes |
| Kit | CCT | Code | Flux (lm) | 80 CRI Typical |
| ANSI Warm White (2700 K - 3750 K) | | | | |
| F6 | 3750 K | P4 | 80.6 | XPCWHT-L1-0000-009F6 |
| | | P3 | 73.9 | XPCWHT-L1-0000-008F6 |
| | | P2 | 67.2 | XPCWHT-L1-0000-007F6 |
| E6 | 3500 K | P4 | 80.6 | XPCWHT-L1-0000-009E6 |
| | | P3 | 73.9 | XPCWHT-L1-0000-008E6 |
| | | P2 | 67.2 | XPCWHT-L1-0000-007E6 |
| F7 | 3250 K | P3 | 73.9 | XPCWHT-L1-0000-008F7 |
| | | P2 | 67.2 | XPCWHT-L1-0000-007F7 |
| | | N4 | 62 | XPCWHT-L1-0000-006F7 |
| E7 | 3000 K | P3 | 73.9 | XPCWHT-L1-0000-008E7 |
| | | P2 | 67.2 | XPCWHT-L1-0000-007E7 |
| | | N4 | 62 | XPCWHT-L1-0000-006E7 |
| F8 | 2850 K | P2 | 67.2 | XPCWHT-L1-0000-007F8 |
| | | N4 | 62 | XPCWHT-L1-0000-006F8 |
| | | N3 | 56.8 | XPCWHT-L1-0000-005F8 |
| E8 | 2700 K | P2 | 67.2 | XPCWHT-L1-0000-007E8 |
| | | N4 | 62 | XPCWHT-L1-0000-006E8 |
| | | N3 | 56.8 | XPCWHT-L1-0000-005E8 |

STANDARD ORDER CODES AND BINS (XP-C COLOR, $T_j = 25\text{ }^\circ\text{C}$)

| XLamp XP-C LED Standard Order Codes - Royal Blue | | | | | | | | |
|--|----------------------------------|-----------|--|--------------------------|-------|----------|-----|----------------------|
| Color | Min. Radiant Flux (mW) @ 350 mA* | | Calculated Min. Radiant Flux (mW) @ 125 mA** | Dominant Wavelength (nm) | | | | Order Codes |
| | Group | Flux (mW) | | Min. | | Max. | | |
| | | | Group | DWL (nm) | Group | DWL (nm) | | |
| Royal Blue | 12 | 250 | 104 | D3 | 450 | D5 | 465 | XPCROY-L1-0000-00701 |
| | | | | D3 | 450 | D4 | 460 | XPCROY-L1-0000-00702 |
| | | | | D4 | 455 | D5 | 465 | XPCROY-L1-0000-00703 |
| | 13 | 300 | 124 | D3 | 450 | D5 | 465 | XPCROY-L1-0000-00801 |
| | | | | D3 | 450 | D4 | 460 | XPCROY-L1-0000-00802 |
| | | | | D4 | 455 | D5 | 465 | XPCROY-L1-0000-00803 |
| | 14 | 350 | 145 | D3 | 450 | D5 | 465 | XPCROY-L1-0000-00901 |
| | | | | D3 | 450 | D4 | 460 | XPCROY-L1-0000-00902 |

** Calculated values for reference only

* Cree XLamp XP Family LED order codes specify only a minimum flux bin and not a maximum. Cree may ship reels in flux bins higher than the minimum specified by the order code without advance notice. Shipments will always adhere to the chromaticity or DWL bin restrictions specified by the order code.

STANDARD ORDER CODES AND BINS (XP-C COLOR, T_j = 25 °C, CONTINUED)

| XLamp XP-C LED Standard Order Codes - Color | | | | | | | | |
|---|--------------------------------------|-----------|---|--------------------------|-------|----------|-----|----------------------|
| Color | Min. Luminous Flux (lm) @ 350 mA* | | Calculated Min. Luminous Flux (lm) @ 125 mA** | Dominant Wavelength (nm) | | | | Order Codes |
| | Group | Flux (lm) | | Min. | | Max. | | |
| | | | Group | DWL (nm) | Group | DWL (nm) | | |
| Blue | J | 23.5 | 10.8 | B3 | 465 | B6 | 485 | XPCBLU-L1-0000-00W01 |
| | | | | B3 | 465 | B5 | 480 | XPCBLU-L1-0000-00W02 |
| | | | | B4 | 470 | B5 | 480 | XPCBLU-L1-0000-00W05 |
| | K2 | 30.6 | 13.8 | B3 | 465 | B6 | 485 | XPCBLU-L1-0000-00Y01 |
| | | | | B3 | 465 | B5 | 480 | XPCBLU-L1-0000-00Y02 |
| | | | | B4 | 470 | B5 | 480 | XPCBLU-L1-0000-00Y05 |
| Green | N3 | 56.8 | 28.2 | G2 | 520 | G4 | 535 | XPCGRN-L1-0000-00501 |
| | | | | G2 | 520 | G3 | 530 | XPCGRN-L1-0000-00502 |
| | | | | G3 | 525 | G4 | 535 | XPCGRN-L1-0000-00503 |
| | N4 | 62.0 | 30.8 | G2 | 520 | G4 | 535 | XPCGRN-L1-0000-00601 |
| | | | | G2 | 520 | G3 | 530 | XPCGRN-L1-0000-00602 |
| | | | | G3 | 525 | G4 | 535 | XPCGRN-L1-0000-00603 |
| | P2 | 67.2 | 33.3 | G2 | 520 | G4 | 535 | XPCGRN-L1-0000-00701 |
| | | | | G2 | 520 | G3 | 530 | XPCGRN-L1-0000-00702 |
| | | | | G3 | 525 | G4 | 535 | XPCGRN-L1-0000-00703 |
| | P3 | 73.9 | 36.7 | G2 | 520 | G4 | 535 | XPCGRN-L1-0000-00801 |
| | | | | G2 | 520 | G3 | 530 | XPCGRN-L1-0000-00802 |
| | | | | G3 | 525 | G4 | 535 | XPCGRN-L1-0000-00803 |
| Amber | M2 | 39.8 | 14.9 | A2 | 585 | A3 | 595 | XPCAMB-L1-0000-00201 |
| | M3 | 45.7 | 17.1 | A2 | 585 | A3 | 595 | XPCAMB-L1-0000-00301 |
| | N2 | 51.7 | 19.4 | A2 | 585 | A3 | 595 | XPCAMB-L1-0000-00401 |
| | N3 | 56.8 | 21.3 | A2 | 585 | A3 | 595 | XPCAMB-L1-0000-00501 |
| Red-Orange | N2 | 51.7 | 19.8 | O3 | 610 | O4 | 620 | XPCRDO-L1-0000-00401 |
| | N3 | 56.8 | 21.7 | O3 | 610 | O4 | 620 | XPCRDO-L1-0000-00501 |
| | N4 | 62.0 | 23.7 | O3 | 610 | O4 | 620 | XPCRDO-L1-0000-00601 |
| | P2 | 67.2 | 25.7 | O3 | 610 | O4 | 620 | XPCRDO-L1-0000-00701 |
| Red | M2 | 39.8 | 15.2 | R2 | 620 | R3 | 630 | XPCRED-L1-0000-00201 |
| | M3 | 45.7 | 17.5 | R2 | 620 | R3 | 630 | XPCRED-L1-0000-00301 |
| | N2 | 51.7 | 19.7 | R2 | 620 | R3 | 630 | XPCRED-L1-0000-00401 |
| | N3 | 56.8 | 21.7 | R2 | 620 | R3 | 630 | XPCRED-L1-0000-00501 |

** Calculated values for reference only

* Cree XLamp XP Family LED order codes specify only a minimum flux bin and not a maximum. Cree may ship reels in flux bins higher than the minimum specified by the order code without advance notice. Shipments will always adhere to the chromaticity or DWL bin restrictions specified by the order code.

STANDARD ORDER CODES AND BINS (XP-E COOL WHITE, T_j = 25 °C)

| XLamp XP-E LED Standard Order Codes - White | | | | |
|---|-----------|--|--|----------------------|
| Minimum Luminous Flux (lm) @ 350 mA* | | Chromaticity Regions | | Order Codes |
| Group | Flux (lm) | | | 70 CRI Typical |
| Cool White (5000 K - 10,000 K) | | | | |
| Q4 | 100 | WA, WB, WC, WD, WE, WF, WG, WH, WJ, WK, WM, WN, WP | | XPEWHT-L1-0000-00C01 |
| | | WC, WD, WF, WG | | XPEWHT-L1-0000-00C02 |
| | | WC, WD, WF, WG, WH, WJ, WN, WP | | XPEWHT-L1-0000-00C03 |
| Q5 | 107 | WA, WB, WC, WD, WE, WF, WG, WH, WJ, WK, WM, WN, WP | | XPEWHT-L1-0000-00D01 |
| | | WC, WD, WF, WG | | XPEWHT-L1-0000-00D02 |
| | | WC, WD, WF, WG, WH, WJ, WN, WP | | XPEWHT-L1-0000-00D03 |
| R2 | 114 | WA, WB, WC, WD, WE, WF, WG, WH, WJ, WK, WM, WN, WP | | XPEWHT-L1-0000-00E01 |
| | | WC, WD, WF, WG | | XPEWHT-L1-0000-00E02 |
| | | WC, WD, WF, WG, WH, WJ, WN, WP | | XPEWHT-L1-0000-00E03 |
| R3 | 122 | WA, WB, WC, WD, WE, WF, WG, WH, WJ, WK, WM, WN, WP | | XPEWHT-L1-0000-00F01 |
| | | WC, WD, WF, WG | | XPEWHT-L1-0000-00F02 |
| | | WC, WD, WF, WG, WH, WJ, WN, WP | | XPEWHT-L1-0000-00F03 |

STANDARD ORDER CODES AND BINS (XP-E ANSI COOL WHITE, T_j = 25 °C)

| XLamp XP-E LED Standard Order Codes - White | | | | |
|---|--------|--------------------------------------|-----------|----------------------|
| Chromaticity | | Minimum Luminous Flux (lm) @ 350 mA* | | Order Codes |
| Kit | CCT | Code | Flux (lm) | 70 CRI Typical |
| ANSI Cool White (5000 K - 8300 K) | | | | |
| 51 | 6200 K | R3 | 122 | XPEWHT-L1-0000-00F51 |
| | | R2 | 114 | XPEWHT-L1-0000-00E51 |
| | | Q5 | 107 | XPEWHT-L1-0000-00D51 |
| | | Q4 | 100 | XPEWHT-L1-0000-00C51 |
| 53 | 6000 K | R3 | 122 | XPEWHT-L1-0000-00F53 |
| | | R2 | 114 | XPEWHT-L1-0000-00E53 |
| | | Q5 | 107 | XPEWHT-L1-0000-00D53 |
| | | Q4 | 100 | XPEWHT-L1-0000-00C53 |
| 50 | 6200 K | R3 | 122 | XPEWHT-L1-0000-00F50 |
| | | R2 | 114 | XPEWHT-L1-0000-00E50 |
| | | Q5 | 107 | XPEWHT-L1-0000-00D50 |
| | | Q4 | 100 | XPEWHT-L1-0000-00C50 |
| E1 | 6500 K | R3 | 122 | XPEWHT-L1-0000-00FE1 |
| | | R2 | 114 | XPEWHT-L1-0000-00EE1 |
| | | Q5 | 107 | XPEWHT-L1-0000-00DE1 |
| | | Q4 | 100 | XPEWHT-L1-0000-00CE1 |
| E2 | 5700 K | R3 | 122 | XPEWHT-L1-0000-00FE2 |
| | | R2 | 114 | XPEWHT-L1-0000-00EE2 |
| | | Q5 | 107 | XPEWHT-L1-0000-00DE2 |
| | | Q4 | 100 | XPEWHT-L1-0000-00CE2 |

* Cree XLamp XP Family LED order codes specify only a minimum flux bin and not a maximum. Cree may ship reels in flux bins higher than the minimum specified by the order code without advance notice. Shipments will always adhere to the chromaticity or DWL bin restrictions specified by the order code.

STANDARD ORDER CODES AND BINS (XP-E NEUTRAL WHITE, OUTDOOR WHITE, T_j = 25 °C)

| XLamp XP-E LED Standard Kit Codes - White | | | | | | |
|---|--------|--------------------------------------|-----------|----------------------|----------------------|----------------------|
| Chromaticity | | Minimum Luminous Flux (lm) @ 350 mA* | | Order Codes | | |
| Kit | CCT | Code | Flux (lm) | 70 CRI Typical | 75 CRI Typical | 80 CRI Minimum |
| ANSI Neutral White (3700 K – 5000 K) | | | | | | |
| E3 | 5000 K | Q5 | 107 | | XPEWHT-L1-0000-00DE3 | |
| | | Q4 | 100 | | XPEWHT-L1-0000-00CE3 | |
| | | Q3 | 93.9 | | XPEWHT-L1-0000-00BE3 | |
| C1 | 5000 K | R3 | 122 | XPEWHT-01-0000-00FC1 | | |
| | | R2 | 114 | XPEWHT-01-0000-00EC1 | | |
| | | Q5 | 107 | XPEWHT-01-0000-00DC1 | | |
| | | Q4 | 100 | XPEWHT-01-0000-00CC1 | | |
| F4 | 4750 K | Q5 | 107 | | XPEWHT-L1-0000-00DF4 | |
| | | Q4 | 100 | | XPEWHT-L1-0000-00CF4 | |
| | | Q3 | 93.9 | | XPEWHT-L1-0000-00BF4 | |
| D1 | 4750 K | R3 | 122 | XPEWHT-01-0000-00FD1 | | |
| | | R2 | 114 | XPEWHT-01-0000-00ED1 | | |
| | | Q5 | 107 | XPEWHT-01-0000-00DD1 | | |
| | | Q4 | 100 | XPEWHT-01-0000-00CD1 | | |
| E4 | 4500 K | Q5 | 107 | | XPEWHT-L1-0000-00DE4 | |
| | | Q4 | 100 | | XPEWHT-L1-0000-00CE4 | |
| | | Q3 | 93.9 | | XPEWHT-L1-0000-00BE4 | |
| D2 | 4500 K | R3 | 122 | XPEWHT-01-0000-00FD2 | | |
| | | R2 | 114 | XPEWHT-01-0000-00ED2 | | |
| | | Q5 | 107 | XPEWHT-01-0000-00DD2 | | |
| | | Q4 | 100 | XPEWHT-01-0000-00CD2 | | |
| C2 | 4500 K | R3 | 122 | XPEWHT-01-0000-00FC2 | | |
| | | R2 | 114 | XPEWHT-01-0000-00EC2 | | |
| | | Q5 | 107 | XPEWHT-01-0000-00DC2 | | |
| | | Q4 | 100 | XPEWHT-01-0000-00CC2 | | |
| C3 | 4300 K | R3 | 122 | XPEWHT-01-0000-00FC3 | | |
| | | R2 | 114 | XPEWHT-01-0000-00EC3 | | |
| | | Q5 | 107 | XPEWHT-01-0000-00DC3 | | |
| | | Q4 | 100 | XPEWHT-01-0000-00CC3 | | |
| F5 | 4250 K | Q5 | 107 | | XPEWHT-L1-0000-00DF5 | |
| | | Q4 | 100 | | XPEWHT-L1-0000-00CF5 | |
| | | Q3 | 93.9 | | XPEWHT-L1-0000-00BF5 | |
| | | Q2 | 87.4 | | XPEWHT-L1-0000-00AF5 | |
| E5 | 4000 K | Q5 | 107 | | XPEWHT-L1-0000-00DE5 | |
| | | Q4 | 100 | | XPEWHT-L1-0000-00CE5 | XPEWHT-H1-0000-00CE5 |
| | | Q3 | 93.9 | | XPEWHT-L1-0000-00BE5 | XPEWHT-H1-0000-00BE5 |
| | | Q2 | 87.4 | | XPEWHT-L1-0000-00AE5 | XPEWHT-H1-0000-00AE5 |
| Z5 | 4000 K | Q4 | 100 | | XPEWHT-L1-0000-00CZ5 | |
| | | Q3 | 93.9 | | XPEWHT-L1-0000-00BZ5 | XPEWHT-H1-0000-00BZ5 |
| | | Q2 | 87.4 | | XPEWHT-L1-0000-00AZ5 | XPEWHT-H1-0000-00AZ5 |

* Cree XLamp XP Family LED order codes specify only a minimum flux bin and not a maximum. Cree may ship reels in flux bins higher than the minimum specified by the order code without advance notice. Shipments will always adhere to the chromaticity or DWL bin restrictions specified by the order code.

STANDARD ORDER CODES AND BINS (XP-E WARM WHITE, T_j = 25 °C)

| XLamp XP-E LED Standard Kit Codes - White | | | | | | | |
|---|--------|--------------------------------------|-----------|----------------------|----------------------|----------------------|----------------------|
| Chromaticity | | Minimum Luminous Flux (lm) @ 350 mA* | | Order Codes | | | |
| Kit | CCT | Code | Flux (lm) | 80 CRI Typical | 80 CRI Minimum | 85 CRI Minimum | 90 CRI Minimum |
| ANSI Warm White (2700 K - 3750 K) | | | | | | | |
| F6 | 3750 K | Q4 | 100 | XPEWHT-L1-0000-00CF6 | | | |
| | | Q3 | 93.9 | XPEWHT-L1-0000-00BF6 | XPEWHT-H1-0000-00BF6 | | |
| | | Q2 | 87.4 | XPEWHT-L1-0000-00AF6 | XPEWHT-H1-0000-00AF6 | | |
| | | P4 | 80.6 | XPEWHT-L1-0000-009F6 | XPEWHT-H1-0000-009F6 | | |
| E6 | 3500 K | Q4 | 100 | XPEWHT-L1-0000-00CE6 | | | |
| | | Q3 | 93.9 | XPEWHT-L1-0000-00BE6 | XPEWHT-H1-0000-00BE6 | | |
| | | Q2 | 87.4 | XPEWHT-L1-0000-00AE6 | XPEWHT-H1-0000-00AE6 | | |
| | | P4 | 80.6 | XPEWHT-L1-0000-009E6 | XPEWHT-H1-0000-009E6 | | |
| Z6 | 3500 K | Q3 | 93.9 | XPEWHT-L1-0000-00BZ6 | | | |
| | | Q2 | 87.4 | XPEWHT-L1-0000-00AZ6 | XPEWHT-H1-0000-00AZ6 | | |
| | | P4 | 80.6 | XPEWHT-L1-0000-009Z6 | XPEWHT-H1-0000-009Z6 | | |
| F7 | 3250 K | Q3 | 93.9 | XPEWHT-L1-0000-00BF7 | | | |
| | | Q2 | 87.4 | XPEWHT-L1-0000-00AF7 | XPEWHT-H1-0000-00AF7 | | |
| | | P4 | 80.6 | XPEWHT-L1-0000-009F7 | XPEWHT-H1-0000-009F7 | | |
| E7 | 3000 K | Q3 | 93.9 | XPEWHT-L1-0000-00BE7 | | | |
| | | Q2 | 87.4 | XPEWHT-L1-0000-00AE7 | XPEWHT-H1-0000-00AE7 | | |
| | | P4 | 80.6 | XPEWHT-L1-0000-009E7 | XPEWHT-H1-0000-009E7 | XPEWHT-P1-0000-009E7 | |
| | | P3 | 73.9 | | | XPEWHT-P1-0000-008E7 | XPEWHT-U1-0000-008E7 |
| | | P2 | 67.2 | | | XPEWHT-P1-0000-007E7 | XPEWHT-U1-0000-007E7 |
| | | N4 | 62 | | | XPEWHT-P1-0000-006E7 | XPEWHT-U1-0000-006E7 |
| Z7 | 3000 K | Q2 | 87.4 | XPEWHT-L1-0000-00AZ7 | XPEWHT-H1-0000-00AZ7 | | |
| | | P4 | 80.6 | XPEWHT-L1-0000-009Z7 | XPEWHT-H1-0000-009Z7 | | |
| | | P3 | 73.9 | | | XPEWHT-P1-0000-008Z7 | |
| | | P2 | 67.2 | | | XPEWHT-P1-0000-007Z7 | XPEWHT-U1-0000-007Z7 |
| | | N4 | 62 | | | XPEWHT-P1-0000-006Z7 | XPEWHT-U1-0000-006Z7 |
| F8 | 2850 K | Q2 | 87.4 | XPEWHT-L1-0000-00AF8 | | | |
| | | P4 | 80.6 | XPEWHT-L1-0000-009F8 | XPEWHT-H1-0000-009F8 | | |
| | | P3 | 73.9 | XPEWHT-L1-0000-008F8 | XPEWHT-H1-0000-008F8 | XPEWHT-P1-0000-008F8 | |
| | | P2 | 67.2 | | | XPEWHT-P1-0000-007F8 | XPEWHT-U1-0000-007F8 |
| | | N4 | 62 | | | XPEWHT-P1-0000-006F8 | XPEWHT-U1-0000-006F8 |
| | | N3 | 56.8 | | | XPEWHT-P1-0000-005F8 | XPEWHT-U1-0000-005F8 |
| E8 | 2700 K | Q2 | 87.4 | XPEWHT-L1-0000-00AE8 | | | |
| | | P4 | 80.6 | XPEWHT-L1-0000-009E8 | XPEWHT-H1-0000-009E8 | | |
| | | P3 | 73.9 | XPEWHT-L1-0000-008E8 | XPEWHT-H1-0000-008E8 | XPEWHT-P1-0000-008E8 | |
| | | P2 | 67.2 | | | XPEWHT-P1-0000-007E8 | XPEWHT-U1-0000-007E8 |
| | | N4 | 62 | | | XPEWHT-P1-0000-006E8 | XPEWHT-U1-0000-006E8 |
| | | N3 | 56.8 | | | XPEWHT-P1-0000-005E8 | XPEWHT-U1-0000-005E8 |
| Z8 | 2700 K | P4 | 80.6 | XPEWHT-L1-0000-009Z8 | XPEWHT-H1-0000-009Z8 | | |
| | | P3 | 73.9 | XPEWHT-L1-0000-008Z8 | XPEWHT-H1-0000-008Z8 | | |
| | | P2 | 67.2 | | | XPEWHT-P1-0000-007Z8 | |
| | | N4 | 62 | | | XPEWHT-P1-0000-006Z8 | XPEWHT-U1-0000-006Z8 |
| | | N3 | 56.8 | | | XPEWHT-P1-0000-005Z8 | XPEWHT-U1-0000-005Z8 |

* Cree XLamp XP Family LED order codes specify only a minimum flux bin and not a maximum. Cree may ship reels in flux bins higher than the minimum specified by the order code without advance notice. Shipments will always adhere to the chromaticity or DWL bin restrictions specified by the order code.

STANDARD ORDER CODES AND BINS (XP-E COLOR, T_j = 25 °C)

| XLamp XP-E LED Standard Order Codes - Royal Blue | | | | | | | |
|--|----------------------------------|-----------|--------------------------|----------|-------|----------|----------------------|
| Color | Min. Radiant Flux (mW) @ 350 mA* | | Dominant Wavelength (nm) | | | | Order Codes |
| | Group | Flux (mW) | Min. | | Max. | | |
| | | | Group | DWL (nm) | Group | DWL (nm) | |
| Royal Blue | 14 | 350 | D3 | 450 | D5 | 465 | XPEROY-L1-0000-00901 |
| | | | D3 | 450 | D4 | 460 | XPEROY-L1-0000-00902 |
| | | | D4 | 455 | D5 | 465 | XPEROY-L1-0000-00903 |
| | 15 | 425 | D3 | 450 | D5 | 465 | XPEROY-L1-0000-00A01 |
| | | | D3 | 450 | D4 | 460 | XPEROY-L1-0000-00A02 |
| | | | D4 | 455 | D5 | 465 | XPEROY-L1-0000-00A03 |
| | 16 | 500 | D3 | 450 | D5 | 465 | XPEROY-L1-0000-00B01 |
| | | | D3 | 450 | D4 | 460 | XPEROY-L1-0000-00B02 |

| XLamp XP-E LED Standard Order Codes - Color | | | | | | | |
|---|-----------------------------------|-----------|--------------------------|----------|-------|----------|----------------------|
| Color | Min. Luminous Flux (lm) @ 350 mA* | | Dominant Wavelength (nm) | | | | Order Codes |
| | Group | Flux (lm) | Min. | | Max. | | |
| | | | Group | DWL (nm) | Group | DWL (nm) | |
| Blue | K2 | 30.6 | B3 | 465 | B6 | 485 | XPEBLU-L1-0000-00Y01 |
| | | | B3 | 465 | B5 | 480 | XPEBLU-L1-0000-00Y02 |
| | | | B4 | 470 | B5 | 480 | XPEBLU-L1-0000-00Y05 |
| | K3 | 35.2 | B3 | 465 | B6 | 485 | XPEBLU-L1-0000-00Z01 |
| | | | B3 | 465 | B5 | 480 | XPEBLU-L1-0000-00Z02 |
| | | | B4 | 470 | B5 | 480 | XPEBLU-L1-0000-00Z05 |
| | M2 | 39.8 | B3 | 465 | B6 | 485 | XPEBLU-L1-0000-00201 |
| | | | B3 | 465 | B5 | 480 | XPEBLU-L1-0000-00202 |
| | | | B4 | 470 | B5 | 480 | XPEBLU-L1-0000-00205 |

* Cree XLamp XP Family LED order codes specify only a minimum flux bin and not a maximum. Cree may ship reels in flux bins higher than the minimum specified by the order code without advance notice. Shipments will always adhere to the chromaticity or DWL bin restrictions specified by the order code.

STANDARD ORDER CODES AND BINS (XP-E COLOR, T_j = 25 °C, CONTINUED)

| XLamp XP-E LED Standard Order Codes - Color | | | | | | | | |
|---|----------------------------------|-----------|--------------------------|----------|-------|----------|----------------------|----------------------|
| Color | Min. Luminous Flux (lm)@ 350 mA* | | Dominant Wavelength (nm) | | | | Order Codes | |
| | Group | Flux (lm) | Min. | | Max. | | | |
| | | | Group | DWL (nm) | Group | DWL (nm) | | |
| Green | P4 | 80.6 | G2 | 520 | G4 | 535 | XPEGRN-L1-0000-00901 | |
| | | | G2 | 520 | G3 | 530 | XPEGRN-L1-0000-00902 | |
| | | | G3 | 525 | G4 | 535 | XPEGRN-L1-0000-00903 | |
| | Q2 | 87.4 | G2 | 520 | G4 | 535 | XPEGRN-L1-0000-00A01 | |
| | | | G2 | 520 | G3 | 530 | XPEGRN-L1-0000-00A02 | |
| | | | G3 | 525 | G4 | 535 | XPEGRN-L1-0000-00A03 | |
| | Q3 | 93.9 | G2 | 520 | G4 | 535 | XPEGRN-L1-0000-00B01 | |
| | | | G2 | 520 | G3 | 530 | XPEGRN-L1-0000-00B02 | |
| | | | G3 | 525 | G4 | 535 | XPEGRN-L1-0000-00B03 | |
| | Q4 | 100 | G2 | 520 | G4 | 535 | XPEGRN-L1-0000-00C01 | |
| | | | G2 | 520 | G3 | 530 | XPEGRN-L1-0000-00C02 | |
| | | | G3 | 525 | G4 | 535 | XPEGRN-L1-0000-00C03 | |
| | Q5 | 107 | G2 | 520 | G4 | 535 | XPEGRN-L1-0000-00D01 | |
| | | | G2 | 520 | G3 | 530 | XPEGRN-L1-0000-00D02 | |
| | | | G3 | 525 | G4 | 535 | XPEGRN-L1-0000-00D03 | |
| | R2 | 114 | G2 | 520 | G4 | 535 | XPEGRN-L1-0000-00E01 | |
| | | | G2 | 520 | G3 | 530 | XPEGRN-L1-0000-00E02 | |
| | | | G3 | 525 | G4 | 535 | XPEGRN-L1-0000-00E03 | |
| | Amber | M3 | 45.7 | A2 | 585 | A3 | 595 | XPEAMB-L1-0000-00301 |
| | | N2 | 51.7 | A2 | 585 | A3 | 595 | XPEAMB-L1-0000-00401 |
| | | N3 | 56.8 | A2 | 585 | A3 | 595 | XPEAMB-L1-0000-00501 |
| | | N4 | 62.0 | A2 | 585 | A3 | 595 | XPEAMB-L1-0000-00601 |
| | | P2 | 67.2 | A2 | 585 | A3 | 595 | XPEAMB-L1-0000-00701 |
| | | P3 | 73.9 | A2 | 585 | A3 | 595 | XPEAMB-L1-0000-00801 |
| P4 | | 80.6 | A2 | 585 | A3 | 595 | XPEAMB-L1-0000-00901 | |
| Red-Orange | N3 | 56.8 | O3 | 610 | O4 | 620 | XPERDO-L1-0000-00501 | |
| | N4 | 62.0 | O3 | 610 | O4 | 620 | XPERDO-L1-0000-00601 | |
| | P2 | 67.2 | O3 | 610 | O4 | 620 | XPERDO-L1-0000-00701 | |
| | P3 | 73.9 | O3 | 610 | O4 | 620 | XPERDO-L1-0000-00801 | |
| | P4 | 80.6 | O3 | 610 | O4 | 620 | XPERDO-L1-0000-00901 | |
| | Q2 | 87.4 | O3 | 610 | O4 | 620 | XPERDO-L1-0000-00A01 | |
| Red | M3 | 45.7 | R2 | 620 | R3 | 630 | XPERED-L1-0000-00301 | |
| | N2 | 51.7 | R2 | 620 | R3 | 630 | XPERED-L1-0000-00401 | |
| | N3 | 56.8 | R2 | 620 | R3 | 630 | XPERED-L1-0000-00501 | |
| | N4 | 62 | R2 | 620 | R3 | 630 | XPERED-L1-0000-00601 | |
| | P2 | 67.2 | R2 | 620 | R3 | 630 | XPERED-L1-0000-00701 | |
| | P3 | 73.9 | R2 | 620 | R3 | 630 | XPERED-L1-0000-00801 | |

* Cree XLamp XP Family LED order codes specify only a minimum flux bin and not a maximum. Cree may ship reels in flux bins higher than the minimum specified by the order code without advance notice. Shipments will always adhere to the chromaticity or DWL bin restrictions specified by the order code.

STANDARD ORDER CODES AND BINS (XP-E2 ANSI COOL WHITE, T_j = 85 °C)

| XLamp XP-E2 LED Standard Order Codes - White | | | | |
|--|--------|--------------------------------------|-----------|----------------------|
| Chromaticity | | Minimum Luminous Flux (lm) @ 350 mA* | | Order Codes |
| Kit | CCT | Code | Flux (lm) | 70 CRI Typical |
| ANSI Cool White (5000 K – 8300 K) | | | | |
| 51 | 6200 K | R3 | 122 | XPEBWT-L1-0000-00F51 |
| | | R2 | 114 | XPEBWT-L1-0000-00E51 |
| | | Q5 | 107 | XPEBWT-L1-0000-00D51 |
| | | Q4 | 100 | XPEBWT-L1-0000-00C51 |
| 53 | 6000 K | R3 | 122 | XPEBWT-L1-0000-00F53 |
| | | R2 | 114 | XPEBWT-L1-0000-00E53 |
| | | Q5 | 107 | XPEBWT-L1-0000-00D53 |
| | | Q4 | 100 | XPEBWT-L1-0000-00C53 |
| 50 | 6200 K | R3 | 122 | XPEBWT-L1-0000-00F50 |
| | | R2 | 114 | XPEBWT-L1-0000-00E50 |
| | | Q5 | 107 | XPEBWT-L1-0000-00D50 |
| | | Q4 | 100 | XPEBWT-L1-0000-00C50 |
| E1 | 6500 K | R3 | 122 | XPEBWT-L1-0000-00FE1 |
| | | R2 | 114 | XPEBWT-L1-0000-00EE1 |
| | | Q5 | 107 | XPEBWT-L1-0000-00DE1 |
| | | Q4 | 100 | XPEBWT-L1-0000-00CE1 |
| E2 | 5700 K | R3 | 122 | XPEBWT-L1-0000-00FE2 |
| | | R2 | 114 | XPEBWT-L1-0000-00EE2 |
| | | Q5 | 107 | XPEBWT-L1-0000-00DE2 |
| | | Q4 | 100 | XPEBWT-L1-0000-00CE2 |

STANDARD ORDER CODES AND BINS (XP-E2 NEUTRAL WHITE, OUTDOOR WHITE, T_j = 85 °C)

| XLamp XP-E2 LED Standard Kit Codes - White | | | | | | |
|--|--------|--------------------------------------|-----------|----------------------|----------------------|----------------|
| Chromaticity | | Minimum Luminous Flux (lm) @ 350 mA* | | Order Codes | | |
| Kit | CCT | Code | Flux (lm) | 70 CRI Typical | 75 CRI Typical | 80 CRI Minimum |
| ANSI Neutral White (3700 K – 5000 K) | | | | | | |
| E3 | 5000 K | R2 | 114 | | XPEBWT-L1-0000-00EE3 | |
| | | Q5 | 107 | | XPEBWT-L1-0000-00DE3 | |
| | | Q4 | 100 | | XPEBWT-L1-0000-00CE3 | |
| C1 | 5000 K | R3 | 122 | XPEBWT-01-0000-00FC1 | | |
| | | R2 | 114 | XPEBWT-01-0000-00EC1 | | |
| | | Q5 | 107 | XPEBWT-01-0000-00DC1 | | |
| | | Q4 | 100 | XPEBWT-01-0000-00CC1 | | |
| F4 | 4750 K | R2 | 114 | | XPEBWT-L1-0000-00EF4 | |
| | | Q5 | 107 | | XPEBWT-L1-0000-00DF4 | |
| | | Q4 | 100 | | XPEBWT-L1-0000-00CF4 | |

* Cree XLamp XP Family LED order codes specify only a minimum flux bin and not a maximum. Cree may ship reels in flux bins higher than the minimum specified by the order code without advance notice. Shipments will always adhere to the chromaticity or DWL bin restrictions specified by the order code.

STANDARD ORDER CODES AND BINS (XP-E2 NEUTRAL WHITE, OUTDOOR WHITE, T_j = 85 °C) - CONTINUED

| XLamp XP-E2 LED Standard Kit Codes - White | | | | | | |
|--|--------|--------------------------------------|-----------|----------------------|----------------------|----------------------|
| Chromaticity | | Minimum Luminous Flux (lm) @ 350 mA* | | Order Codes | | |
| Kit | CCT | Code | Flux (lm) | 70 CRI Typical | 75 CRI Typical | 80 CRI Minimum |
| ANSI Neutral White (3700 K – 5000 K) | | | | | | |
| D1 | 4750 K | R3 | 122 | XPEBWT-01-0000-00FD1 | | |
| | | R2 | 114 | XPEBWT-01-0000-00ED1 | | |
| | | Q5 | 107 | XPEBWT-01-0000-00DD1 | | |
| | | Q4 | 100 | XPEBWT-01-0000-00CD1 | | |
| E4 | 4500 K | R2 | 114 | | XPEBWT-L1-0000-00EE4 | |
| | | Q5 | 107 | | XPEBWT-L1-0000-00DE4 | |
| | | Q4 | 100 | | XPEBWT-L1-0000-00CE4 | |
| D2 | 4500 K | R3 | 122 | XPEBWT-01-0000-00FD2 | | |
| | | R2 | 114 | XPEBWT-01-0000-00ED2 | | |
| | | Q5 | 107 | XPEBWT-01-0000-00DD2 | | |
| | | Q4 | 100 | XPEBWT-01-0000-00CD2 | | |
| C2 | 4500 K | R3 | 122 | XPEBWT-01-0000-00FC2 | | |
| | | R2 | 114 | XPEBWT-01-0000-00EC2 | | |
| | | Q5 | 107 | XPEBWT-01-0000-00DC2 | | |
| | | Q4 | 100 | XPEBWT-01-0000-00CC2 | | |
| C3 | 4300 K | R3 | 122 | XPEBWT-01-0000-00FC3 | | |
| | | R2 | 114 | XPEBWT-01-0000-00EC3 | | |
| | | Q5 | 107 | XPEBWT-01-0000-00DC3 | | |
| | | Q4 | 100 | XPEBWT-01-0000-00CC3 | | |
| F5 | 4250 K | R2 | 114 | | XPEBWT-L1-0000-00EF5 | |
| | | Q5 | 107 | | XPEBWT-L1-0000-00DF5 | |
| | | Q4 | 100 | | XPEBWT-L1-0000-00CF5 | |
| | | Q3 | 93.9 | | XPEBWT-L1-0000-00BF5 | |
| E5 | 4000 K | R2 | 114 | | XPEBWT-L1-0000-00EE5 | |
| | | Q5 | 107 | | XPEBWT-L1-0000-00DE5 | XPEBWT-H1-0000-00DE5 |
| | | Q4 | 100 | | XPEBWT-L1-0000-00CE5 | XPEBWT-H1-0000-00CE5 |
| | | Q3 | 93.9 | | XPEBWT-L1-0000-00BE5 | XPEBWT-H1-0000-00BE5 |
| Z5 | 4000 K | Q5 | 107 | | XPEBWT-L1-0000-00DZ5 | |
| | | Q4 | 100 | | XPEBWT-L1-0000-00CZ5 | XPEBWT-H1-0000-00CZ5 |
| | | Q3 | 93.9 | | XPEBWT-L1-0000-00BZ5 | XPEBWT-H1-0000-00BZ5 |

* Cree XLamp XP Family LED order codes specify only a minimum flux bin and not a maximum. Cree may ship reels in flux bins higher than the minimum specified by the order code without advance notice. Shipments will always adhere to the chromaticity or DWL bin restrictions specified by the order code.

STANDARD ORDER CODES AND BINS (XP-E2 WARM WHITE, T_j = 85 °C)

| XLamp XP-E2 LED Standard Kit Codes - White | | | | | | | |
|--|--------|--------------------------------------|-----------|----------------------|----------------------|----------------------|----------------------|
| Chromaticity | | Minimum Luminous Flux (lm) @ 350 mA* | | Order Codes | | | |
| Kit | CCT | Code | Flux (lm) | 80 CRI Typical | 80 CRI Minimum | 85 CRI Minimum | 90 CRI Minimum |
| ANSI Warm White (2700 K - 3750 K) | | | | | | | |
| F6 | 3750 K | Q5 | 107 | XPEBWT-L1-0000-00DF6 | | | |
| | | Q4 | 100 | XPEBWT-L1-0000-00CF6 | XPEBWT-H1-0000-00CF6 | | |
| | | Q3 | 93.9 | XPEBWT-L1-0000-00BF6 | XPEBWT-H1-0000-00BF6 | | |
| | | Q2 | 87.4 | XPEBWT-L1-0000-00AF6 | XPEBWT-H1-0000-00AF6 | | |
| E6 | 3500 K | Q5 | 107 | XPEBWT-L1-0000-00DE6 | | | |
| | | Q4 | 100 | XPEBWT-L1-0000-00CE6 | XPEBWT-H1-0000-00CE6 | | |
| | | Q3 | 93.9 | XPEBWT-L1-0000-00BE6 | XPEBWT-H1-0000-00BE6 | | |
| | | Q2 | 87.4 | XPEBWT-L1-0000-00AE6 | XPEBWT-H1-0000-00AE6 | | |
| Z6 | 3500 K | Q4 | 100 | XPEBWT-L1-0000-00CZ6 | | | |
| | | Q3 | 93.9 | XPEBWT-L1-0000-00BZ6 | XPEBWT-H1-0000-00BZ6 | | |
| | | Q2 | 87.4 | XPEBWT-L1-0000-00AZ6 | XPEBWT-H1-0000-00AZ6 | | |
| F7 | 3250 K | Q4 | 100 | XPEBWT-L1-0000-00CF7 | | | |
| | | Q3 | 93.9 | XPEBWT-L1-0000-00BF7 | XPEBWT-H1-0000-00BF7 | | |
| | | Q2 | 87.4 | XPEBWT-L1-0000-00AF7 | XPEBWT-H1-0000-00AF7 | | |
| E7 | 3000 K | Q4 | 100 | XPEBWT-L1-0000-00CE7 | | | |
| | | Q3 | 93.9 | XPEBWT-L1-0000-00BE7 | XPEBWT-H1-0000-00BE7 | | |
| | | Q2 | 87.4 | XPEBWT-L1-0000-00AE7 | XPEBWT-H1-0000-00AE7 | XPEBWT-P1-0000-00AE7 | |
| | | P4 | 80.6 | | | XPEBWT-P1-0000-009E7 | XPEBWT-U1-0000-009E7 |
| | | P3 | 73.9 | | | XPEBWT-P1-0000-008E7 | XPEBWT-U1-0000-008E7 |
| | | P2 | 67.2 | | | XPEBWT-P1-0000-007E7 | XPEBWT-U1-0000-007E7 |
| Z7 | 3000 K | Q3 | 93.9 | XPEBWT-L1-0000-00BZ7 | XPEBWT-H1-0000-00BZ7 | | |
| | | Q2 | 87.4 | XPEBWT-L1-0000-00AZ7 | XPEBWT-H1-0000-00AZ7 | | |
| | | P4 | 80.6 | | | XPEBWT-P1-0000-009Z7 | |
| | | P3 | 73.9 | | | XPEBWT-P1-0000-008Z7 | XPEBWT-U1-0000-008Z7 |
| | | P2 | 67.2 | | | XPEBWT-P1-0000-007Z7 | XPEBWT-U1-0000-007Z7 |
| F8 | 2850 K | Q3 | 93.9 | XPEBWT-L1-0000-00BF8 | | | |
| | | Q2 | 87.4 | XPEBWT-L1-0000-00AF8 | XPEBWT-H1-0000-00AF8 | | |
| | | P4 | 80.6 | XPEBWT-L1-0000-009F8 | XPEBWT-H1-0000-009F8 | XPEBWT-P1-0000-009F8 | |
| | | P3 | 73.9 | | | XPEBWT-P1-0000-008F8 | XPEBWT-U1-0000-008F8 |
| | | P2 | 67.2 | | | XPEBWT-P1-0000-007F8 | XPEBWT-U1-0000-007F8 |
| | | N4 | 62 | | | XPEBWT-P1-0000-006F8 | XPEBWT-U1-0000-006F8 |
| E8 | 2700 K | Q3 | 93.9 | XPEBWT-L1-0000-00BE8 | | | |
| | | Q2 | 87.4 | XPEBWT-L1-0000-00AE8 | XPEBWT-H1-0000-00AE8 | | |
| | | P4 | 80.6 | XPEBWT-L1-0000-009E8 | XPEBWT-H1-0000-009E8 | XPEBWT-P1-0000-009E8 | |
| | | P3 | 73.9 | | | XPEBWT-P1-0000-008E8 | XPEBWT-U1-0000-008E8 |
| | | P2 | 67.2 | | | XPEBWT-P1-0000-007E8 | XPEBWT-U1-0000-007E8 |
| | | N4 | 62 | | | XPEBWT-P1-0000-006E8 | XPEBWT-U1-0000-006E8 |

* Cree XLamp XP Family LED order codes specify only a minimum flux bin and not a maximum. Cree may ship reels in flux bins higher than the minimum specified by the order code without advance notice. Shipments will always adhere to the chromaticity or DWL bin restrictions specified by the order code.

STANDARD ORDER CODES AND BINS (XP-E2 WARM WHITE, T_j = 85 °C)

| XLamp XP-E2 LED Standard Kit Codes - White | | | | | | | |
|--|--------|--------------------------------------|-----------|----------------------|----------------------|----------------------|----------------------|
| Chromaticity | | Minimum Luminous Flux (lm) @ 350 mA* | | Order Codes | | | |
| Kit | CCT | Code | Flux (lm) | 80 CRI Typical | 80 CRI Minimum | 85 CRI Minimum | 90 CRI Minimum |
| ANSI Warm White (2700 K - 3750 K) | | | | | | | |
| Z8 | 2700 K | Q2 | 87.4 | XPEBWT-L1-0000-00AZ8 | XPEBWT-H1-0000-00AZ8 | | |
| | | P4 | 80.6 | XPEBWT-L1-0000-009Z8 | XPEBWT-H1-0000-009Z8 | | |
| | | P3 | 73.9 | | | XPEBWT-P1-0000-008Z8 | |
| | | P2 | 67.2 | | | XPEBWT-P1-0000-007Z8 | XPEBWT-U1-0000-007Z8 |
| | | N4 | 62 | | | XPEBWT-P1-0000-006Z8 | XPEBWT-U1-0000-006Z8 |
| EA | 2200 K | P2 | 67.2 | XPEBWT-L1-0000-007EA | XPEBWT-H1-0000-007EA | | |
| | | N4 | 62 | XPEBWT-L1-0000-006EA | XPEBWT-H1-0000-006EA | | |

STANDARD ORDER CODES AND BINS (XP-E2 COLOR, T_j = 25 °C)

| XLamp XP-E2 LED Standard Order Codes - Royal Blue | | | | | | | |
|---|-------------------------------|-----------|--------------------------|----------|-------|----------|----------------------|
| Color | Minimum Radiant Flux @ 350 mA | | Dominant Wavelength (nm) | | | | Order Codes |
| | Group | Flux (mW) | Min. | | Max. | | |
| | | | Group | DWL (nm) | Group | DWL (nm) | |
| Royal Blue | 30 | 450 | D3 | 450 | D5 | 465 | XPEBRY-L1-0000-00J01 |
| | | | D3 | 450 | D4 | 460 | XPEBRY-L1-0000-00J02 |
| | | | D4 | 455 | D5 | 465 | XPEBRY-L1-0000-00J03 |
| | 31 | 475 | D3 | 450 | D5 | 455 | XPEBRY-L1-0000-00K01 |
| | | | D3 | 450 | D4 | 460 | XPEBRY-L1-0000-00K02 |
| | | | D4 | 455 | D5 | 465 | XPEBRY-L1-0000-00K03 |
| | 32 | 500 | D3 | 450 | D5 | 455 | XPEBRY-L1-0000-00L01 |
| | | | D3 | 450 | D4 | 460 | XPEBRY-L1-0000-00L02 |
| | | | D4 | 455 | D5 | 465 | XPEBRY-L1-0000-00L03 |
| | 33 | 525 | D3 | 450 | D5 | 455 | XPEBRY-L1-0000-00M01 |
| | | | D3 | 450 | D4 | 460 | XPEBRY-L1-0000-00M02 |
| | | | D4 | 455 | D5 | 465 | XPEBRY-L1-0000-00M03 |
| | 34 | 550 | D3 | 450 | D5 | 455 | XPEBRY-L1-0000-00N01 |
| | | | D3 | 450 | D4 | 460 | XPEBRY-L1-0000-00N02 |
| | | | D4 | 455 | D5 | 465 | XPEBRY-L1-0000-00N03 |
| | 35 | 575 | D3 | 450 | D5 | 465 | XPEBRY-L1-0000-00P01 |
| | | | D3 | 450 | D4 | 460 | XPEBRY-L1-0000-00P02 |

* Cree XLamp XP Family LED order codes specify only a minimum flux bin and not a maximum. Cree may ship reels in flux bins higher than the minimum specified by the order code without advance notice. Shipments will always adhere to the chromaticity or DWL bin restrictions specified by the order code.

STANDARD ORDER CODES AND BINS (XP-E2 COLOR, T_j = 25 °C, CONTINUED)

| XLamp XP-E2 LED Standard Order Codes - Color | | | | | | | |
|--|-----------------------------------|-----------|--------------------------|----------|-------|----------------------|----------------------|
| Color | Min. Luminous Flux (lm) @ 350 mA* | | Dominant Wavelength (nm) | | | | Order Codes |
| | Group | Flux (lm) | Min. | | Max. | | |
| | | | Group | DWL (nm) | Group | DWL (nm) | |
| Blue | K2 | 30.6 | B3 | 465 | B6 | 485 | XPEBBL-L1-0000-00Y01 |
| | | | B3 | 465 | B5 | 480 | XPEBBL-L1-0000-00Y02 |
| | | | B4 | 470 | B5 | 480 | XPEBBL-L1-0000-00Y05 |
| | K3 | 35.2 | B3 | 465 | B6 | 485 | XPEBBL-L1-0000-00Z01 |
| | | | B3 | 465 | B5 | 480 | XPEBBL-L1-0000-00Z02 |
| | | | B4 | 470 | B5 | 480 | XPEBBL-L1-0000-00Z05 |
| | M2 | 39.8 | B3 | 465 | B6 | 485 | XPEBBL-L1-0000-00201 |
| | | | B3 | 465 | B5 | 480 | XPEBBL-L1-0000-00202 |
| | | | B4 | 470 | B5 | 480 | XPEBBL-L1-0000-00205 |
| | M3 | 45.7 | B3 | 465 | B6 | 485 | XPEBBL-L1-0000-00301 |
| | | | B3 | 465 | B5 | 480 | XPEBBL-L1-0000-00302 |
| | | | B4 | 470 | B5 | 480 | XPEBBL-L1-0000-00305 |
| Green | Q2 | 87.4 | G2 | 520 | G4 | 535 | XPEBGR-L1-0000-00A01 |
| | | | G2 | 520 | G3 | 530 | XPEBGR-L1-0000-00A02 |
| | | | G3 | 525 | G4 | 535 | XPEBGR-L1-0000-00A03 |
| | Q3 | 93.9 | G2 | 520 | G4 | 535 | XPEBGR-L1-0000-00B01 |
| | | | G2 | 520 | G3 | 530 | XPEBGR-L1-0000-00B02 |
| | | | G3 | 525 | G4 | 535 | XPEBGR-L1-0000-00B03 |
| | Q4 | 100 | G2 | 520 | G4 | 535 | XPEBGR-L1-0000-00C01 |
| | | | G2 | 520 | G3 | 530 | XPEBGR-L1-0000-00C02 |
| | | | G3 | 525 | G4 | 535 | XPEBGR-L1-0000-00C03 |
| | Q5 | 107 | G2 | 520 | G4 | 535 | XPEBGR-L1-0000-00D01 |
| | | | G2 | 520 | G3 | 530 | XPEBGR-L1-0000-00D02 |
| | | | G3 | 525 | G4 | 535 | XPEBGR-L1-0000-00D03 |
| | R2 | 114 | G2 | 520 | G4 | 535 | XPEBGR-L1-0000-00E01 |
| | | | G2 | 520 | G3 | 530 | XPEBGR-L1-0000-00E02 |
| | | | G3 | 525 | G4 | 535 | XPEBGR-L1-0000-00E03 |
| R3 | 122 | G2 | 520 | G4 | 535 | XPEBGR-L1-0000-00F01 | |
| | | G2 | 520 | G3 | 530 | XPEBGR-L1-0000-00F02 | |

| Color | Color Bin | Min. Luminous Flux (lm) @ 350 mA | | Order Code |
|----------|-----------|----------------------------------|-----------|----------------------|
| | | Group | Flux (lm) | |
| PC Amber | Y2 | Q2 | 87.4 | XPEBPA-L1-0000-00A01 |
| | | Q3 | 93.9 | XPEBPA-L1-0000-00B01 |
| | | Q4 | 100 | XPEBPA-L1-0000-00C01 |

* Cree XLamp XP Family LED order codes specify only a minimum flux bin and not a maximum. Cree may ship reels in flux bins higher than the minimum specified by the order code without advance notice. Shipments will always adhere to the chromaticity or DWL bin restrictions specified by the order code.

STANDARD ORDER CODES AND BINS (XP-E2 COLOR, T_j = 25 °C, CONTINUED)

| XLamp XP-E2 LED Standard Order Codes - Color | | | | | | | | |
|--|-----------------------------------|-----------|--------------------------|----------|-------|----------|----------------------|----------------------|
| Color | Min. Luminous Flux (lm) @ 350 mA* | | Dominant Wavelength (nm) | | | | Order Codes | |
| | Group | Flux (lm) | Min. | | Max. | | | |
| | | | Group | DWL (nm) | Group | DWL (nm) | | |
| Amber | N4 | 62.0 | A2 | 585 | A3 | 595 | XPEBAM-L1-0000-00601 | |
| | | | A2 | 585 | A2 | 590 | XPEBAM-L1-0000-00602 | |
| | | | A3 | 590 | A3 | 595 | XPEBAM-L1-0000-00603 | |
| | P2 | 67.2 | A2 | 585 | A3 | 595 | XPEBAM-L1-0000-00701 | |
| | | | A2 | 585 | A2 | 590 | XPEBAM-L1-0000-00702 | |
| | | | A3 | 590 | A3 | 595 | XPEBAM-L1-0000-00703 | |
| | P3 | 73.9 | A2 | 585 | A3 | 595 | XPEBAM-L1-0000-00801 | |
| | | | A2 | 585 | A2 | 590 | XPEBAM-L1-0000-00802 | |
| | | | A3 | 590 | A3 | 595 | XPEBAM-L1-0000-00803 | |
| | P4 | 80.6 | A2 | 585 | A3 | 595 | XPEBAM-L1-0000-00901 | |
| | | | A3 | 590 | A3 | 595 | XPEBAM-L1-0000-00903 | |
| | Red-Orange | P2 | 67.2 | O3 | 610 | O4 | 620 | XPEBRO-L1-0000-00701 |
| O3 | | | | 610 | O3 | 615 | XPEBRO-L1-0000-00702 | |
| O4 | | | | 615 | O4 | 620 | XPEBRO-L1-0000-00703 | |
| P3 | | 73.9 | O3 | 610 | O4 | 620 | XPEBRO-L1-0000-00801 | |
| | | | O3 | 610 | O3 | 615 | XPEBRO-L1-0000-00802 | |
| | | | O4 | 615 | O4 | 620 | XPEBRO-L1-0000-00803 | |
| P4 | | 80.6 | O3 | 610 | O4 | 620 | XPEBRO-L1-0000-00901 | |
| | | | O3 | 610 | O3 | 615 | XPEBRO-L1-0000-00902 | |
| | | | O4 | 615 | O4 | 620 | XPEBRO-L1-0000-00903 | |
| Q2 | | 87.4 | O3 | 610 | O4 | 620 | XPEBRO-L1-0000-00A01 | |
| | | | O3 | 610 | O3 | 615 | XPEBRO-L1-0000-00A02 | |
| | | | O4 | 615 | O4 | 620 | XPEBRO-L1-0000-00A03 | |
| Q3 | | 93.9 | O3 | 610 | O4 | 620 | XPEBRO-L1-0000-00B01 | |
| | | | O3 | 610 | O3 | 615 | XPEBRO-L1-0000-00B02 | |
| Q4 | | 100 | O3 | 610 | O4 | 620 | XPEBRO-L1-0000-00C01 | |
| | | | O3 | 610 | O3 | 615 | XPEBRO-L1-0000-00C02 | |
| Red | | N3 | 56.8 | R2 | 620 | R3 | 630 | XPEBRD-L1-0000-00501 |
| | | | | R2 | 620 | R2 | 625 | XPEBRD-L1-0000-00502 |
| | N4 | 62 | R2 | 620 | R3 | 630 | XPEBRD-L1-0000-00601 | |
| | | | R2 | 620 | R2 | 625 | XPEBRD-L1-0000-00602 | |
| | P2 | 67.2 | R2 | 620 | R3 | 630 | XPEBRD-L1-0000-00701 | |
| | | | R2 | 620 | R2 | 625 | XPEBRD-L1-0000-00702 | |
| | P3 | 73.9 | R2 | 620 | R3 | 630 | XPEBRD-L1-0000-00801 | |
| | | | R2 | 620 | R2 | 625 | XPEBRD-L1-0000-00802 | |

* Cree XLamp XP Family LED order codes specify only a minimum flux bin and not a maximum. Cree may ship reels in flux bins higher than the minimum specified by the order code without advance notice. Shipments will always adhere to the chromaticity or DWL bin restrictions specified by the order code.

STANDARD ORDER CODES AND BINS (XP-E HEW ANSI COOL WHITE, T_j = 25 °C)

| XLamp XP-E High Efficiency White LED Order Codes - White | | | | |
|--|--------|--------------------------------------|-----------|----------------------|
| Chromaticity | | Minimum Luminous Flux (lm) @ 350 mA* | | Order Codes |
| Kit | CCT | Code | Flux (lm) | 68 CRI Typical |
| ANSI Cool White (5000 K – 8300 K) | | | | |
| 51 | 6200 K | R5 | 139 | XPEHEW-L1-0000-00H51 |
| | | R4 | 130 | XPEHEW-L1-0000-00G51 |
| | | R3 | 122 | XPEHEW-L1-0000-00F51 |
| 53 | 6000 K | R5 | 139 | XPEHEW-L1-0000-00H53 |
| | | R4 | 130 | XPEHEW-L1-0000-00G53 |
| | | R3 | 122 | XPEHEW-L1-0000-00F53 |
| 50 | 6200 K | R5 | 139 | XPEHEW-L1-0000-00H50 |
| | | R4 | 130 | XPEHEW-L1-0000-00G50 |
| | | R3 | 122 | XPEHEW-L1-0000-00F50 |

* Cree XLamp XP Family LED order codes specify only a minimum flux bin and not a maximum. Cree may ship reels in flux bins higher than the minimum specified by the order code without advance notice. Shipments will always adhere to the chromaticity or DWL bin restrictions specified by the order code.

STANDARD ORDER CODES AND BINS (XP-E HEW NEUTRAL WHITE, OUTDOOR WHITE, T_j = 25 °C)

| XLamp XP-E High Efficiency White LED Standard Kit Codes - White | | | | | | |
|---|--------|--------------------------------------|-----------|----------------------|----------------------|----------------------|
| Chromaticity | | Minimum Luminous Flux (lm) @ 350 mA* | | Order Codes | | |
| Kit | CCT | Code | Flux (lm) | 70 CRI Typical | 75 CRI Typical | 80 CRI Minimum |
| ANSI Neutral White (3700 K – 5000 K) | | | | | | |
| E3 | 5000 K | R3 | 122 | XPEHEW-01-0000-00FE3 | XPEHEW-L1-0000-00FE3 | |
| | | R2 | 114 | XPEHEW-01-0000-00EE3 | XPEHEW-L1-0000-00EE3 | |
| | | Q5 | 107 | | XPEHEW-L1-0000-00DE3 | |
| C1 | 5000 K | R4 | 130 | XPEHEW-01-0000-00GC1 | | |
| | | R3 | 122 | XPEHEW-01-0000-00FC1 | | |
| | | R2 | 114 | XPEHEW-01-0000-00EC1 | | |
| F4 | 4750 K | R3 | 122 | XPEHEW-01-0000-00FF4 | XPEHEW-L1-0000-00FF4 | |
| | | R2 | 114 | XPEHEW-01-0000-00EF4 | XPEHEW-L1-0000-00EF4 | |
| | | Q5 | 107 | | XPEHEW-L1-0000-00DF4 | |
| D1 | 4750 K | R4 | 130 | XPEHEW-01-0000-00GD1 | | |
| | | R3 | 122 | XPEHEW-01-0000-00FD1 | | |
| | | R2 | 114 | XPEHEW-01-0000-00ED1 | | |
| E4 | 4500 K | R3 | 122 | XPEHEW-01-0000-00FE4 | XPEHEW-L1-0000-00FE4 | |
| | | R2 | 114 | XPEHEW-01-0000-00EE4 | XPEHEW-L1-0000-00EE4 | |
| | | Q5 | 107 | | XPEHEW-L1-0000-00DE4 | |
| D2 | 4500 K | R4 | 130 | XPEHEW-01-0000-00GD2 | | |
| | | R3 | 122 | XPEHEW-01-0000-00FD2 | | |
| | | R2 | 114 | XPEHEW-01-0000-00ED2 | | |
| C2 | 4500 K | R4 | 130 | XPEHEW-01-0000-00GC2 | | |
| | | R3 | 122 | XPEHEW-01-0000-00FC2 | | |
| | | R2 | 114 | XPEHEW-01-0000-00EC2 | | |
| C3 | 4300 K | R4 | 130 | XPEHEW-01-0000-00GC3 | | |
| | | R3 | 122 | XPEHEW-01-0000-00FC3 | | |
| | | R2 | 114 | XPEHEW-01-0000-00EC3 | | |
| F5 | 4250 K | R3 | 122 | XPEHEW-01-0000-00FF5 | XPEHEW-L1-0000-00FF5 | |
| | | R2 | 114 | XPEHEW-01-0000-00EF5 | XPEHEW-L1-0000-00EF5 | |
| | | Q5 | 107 | | XPEHEW-L1-0000-00DF5 | |
| E5 | 4000 K | R3 | 122 | XPEHEW-01-0000-00FE5 | XPEHEW-L1-0000-00FE5 | |
| | | R2 | 114 | XPEHEW-01-0000-00EE5 | XPEHEW-L1-0000-00EE5 | XPEHEW-H1-0000-00EE5 |
| | | Q5 | 107 | | XPEHEW-L1-0000-00DE5 | XPEHEW-H1-0000-00DE5 |

* Cree XLamp XP Family LED order codes specify only a minimum flux bin and not a maximum. Cree may ship reels in flux bins higher than the minimum specified by the order code without advance notice. Shipments will always adhere to the chromaticity or DWL bin restrictions specified by the order code.

STANDARD ORDER CODES AND BINS (XP-E HEW NEUTRAL WHITE, OUTDOOR WHITE, TJ = 25 °C, CONTINUED)

| XLamp XP-E High Efficiency White LED Standard Kit Codes - White | | | | | | | | |
|---|--------|--------------------------------------|-----------|----------------------|----------------------|----------------------|----------------------|----------------------|
| Chromaticity | | Minimum Luminous Flux (lm) @ 350 mA* | | Order Codes | | | | |
| Kit | CCT | Code | Flux (lm) | 70 CRI Typical | 80 CRI Typical | 80 CRI Minimum | 85 CRI Minimum | 90 CRI Minimum |
| ANSI Warm White (2700 K - 3750 K) | | | | | | | | |
| F6 | 3750 K | R2 | 114 | XPEHEW-01-0000-00EF6 | XPEHEW-L1-0000-00EF6 | XPEHEW-H1-0000-00EF6 | | |
| | | Q5 | 107 | XPEHEW-01-0000-00DF6 | XPEHEW-L1-0000-00DF6 | XPEHEW-H1-0000-00DF6 | | |
| | | Q4 | 100 | | XPEHEW-L1-0000-00CF6 | XPEHEW-H1-0000-00CF6 | | |
| E6 | 3500 K | R2 | 114 | XPEHEW-01-0000-00EE6 | XPEHEW-L1-0000-00EE6 | | | |
| | | Q5 | 107 | XPEHEW-01-0000-00DE6 | XPEHEW-L1-0000-00DE6 | XPEHEW-H1-0000-00DE6 | | |
| | | Q4 | 100 | | XPEHEW-L1-0000-00CE6 | XPEHEW-H1-0000-00CE6 | | |
| F7 | 3250 K | R2 | 114 | XPEHEW-01-0000-00EF7 | | | | |
| | | Q5 | 107 | XPEHEW-01-0000-00DF7 | XPEHEW-L1-0000-00DF7 | XPEHEW-H1-0000-00DF7 | | |
| | | Q4 | 100 | XPEHEW-01-0000-00CF7 | XPEHEW-L1-0000-00CF7 | XPEHEW-H1-0000-00CF7 | | |
| | | Q3 | 93.9 | | XPEHEW-L1-0000-00BF7 | XPEHEW-H1-0000-00BF7 | | |
| | | P3 | 73.9 | | | | | |
| E7 | 3000 K | R2 | 114 | XPEHEW-01-0000-00EE7 | | | | |
| | | Q5 | 107 | XPEHEW-01-0000-00DE7 | XPEHEW-L1-0000-00DE7 | | | |
| | | Q4 | 100 | XPEHEW-01-0000-00CE7 | XPEHEW-L1-0000-00CE7 | XPEHEW-H1-0000-00CE7 | | |
| | | Q3 | 93.9 | | XPEHEW-L1-0000-00BE7 | XPEHEW-H1-0000-00BE7 | XPEHEW-P1-0000-00BE7 | |
| | | Q2 | 87.4 | | | | XPEHEW-P1-0000-00AE7 | XPEHEW-U1-0000-00AE7 |
| | | P4 | 80.6 | | | | XPEHEW-P1-0000-009E7 | XPEHEW-U1-0000-009E7 |
| F8 | 2850 K | Q5 | 107 | XPEHEW-01-0000-00DF8 | | | | |
| | | Q4 | 100 | XPEHEW-01-0000-00CF8 | XPEHEW-L1-0000-00CF8 | XPEHEW-H1-0000-00CF8 | | |
| | | Q3 | 93.9 | | XPEHEW-L1-0000-00BF8 | XPEHEW-H1-0000-00BF8 | | |
| | | Q2 | 87.4 | | XPEHEW-L1-0000-00AF8 | XPEHEW-H1-0000-00AF8 | XPEHEW-P1-0000-00AF8 | XPEHEW-U1-0000-00AF8 |
| | | P4 | 80.6 | | | | XPEHEW-P1-0000-009F8 | XPEHEW-U1-0000-009F8 |
| | | P3 | 73.9 | | | | XPEHEW-P1-0000-008F8 | XPEHEW-U1-0000-008F8 |
| E8 | 2700 K | Q5 | 107 | XPEHEW-01-0000-00DE8 | | | | |
| | | Q4 | 100 | XPEHEW-01-0000-00CE8 | XPEHEW-L1-0000-00CE8 | | | |
| | | Q3 | 93.9 | | XPEHEW-L1-0000-00BE8 | XPEHEW-H1-0000-00BE8 | | |
| | | Q2 | 87.4 | | XPEHEW-L1-0000-00AE8 | XPEHEW-H1-0000-00AE8 | XPEHEW-P1-0000-00AE8 | |
| | | P4 | 80.6 | | | | XPEHEW-P1-0000-009E8 | XPEHEW-U1-0000-009E8 |
| | | P3 | 73.9 | | | | XPEHEW-P1-0000-008E8 | XPEHEW-U1-0000-008E8 |

* Cree XLamp XP Family LED order codes specify only a minimum flux bin and not a maximum. Cree may ship reels in flux bins higher than the minimum specified by the order code without advance notice. Shipments will always adhere to the chromaticity or DWL bin restrictions specified by the order code.

STANDARD ORDER CODES AND BINS (XP-G ANSI COOL WHITE, T_j = 25 °C)

| XLamp XP-G LED Standard Order Codes - White | | | | |
|---|--------|--------------------------------------|-----------|----------------------|
| Chromaticity | | Minimum Luminous Flux (lm) @ 350 mA* | | Order Codes |
| Kit | CCT | Code | Flux (lm) | 70 CRI Typical |
| ANSI Cool White (5000 K – 8300 K) | | | | |
| 51 | 6200 K | R5 | 139 | XPGWHT-L1-0000-00H51 |
| | | R4 | 130 | XPGWHT-L1-0000-00G51 |
| | | R3 | 122 | XPGWHT-L1-0000-00F51 |
| 53 | 6000 K | R5 | 139 | XPGWHT-L1-0000-00H53 |
| | | R4 | 130 | XPGWHT-L1-0000-00G53 |
| | | R3 | 122 | XPGWHT-L1-0000-00F53 |
| 50 | 6200 K | R5 | 139 | XPGWHT-L1-0000-00H50 |
| | | R4 | 130 | XPGWHT-L1-0000-00G50 |
| | | R3 | 122 | XPGWHT-L1-0000-00F50 |
| E1 | 6500 K | R5 | 139 | XPGWHT-L1-0000-00HE1 |
| | | R4 | 130 | XPGWHT-L1-0000-00GE1 |
| | | R3 | 122 | XPGWHT-L1-0000-00FE1 |
| E2 | 5700 K | R5 | 139 | XPGWHT-L1-0000-00HE2 |
| | | R4 | 130 | XPGWHT-L1-0000-00GE2 |
| | | R3 | 122 | XPGWHT-L1-0000-00FE2 |

* Cree XLamp XP Family LED order codes specify only a minimum flux bin and not a maximum. Cree may ship reels in flux bins higher than the minimum specified by the order code without advance notice. Shipments will always adhere to the chromaticity or DWL bin restrictions specified by the order code.

STANDARD ORDER CODES AND BINS (XP-G NEUTRAL WHITE, OUTDOOR WHITE, T_j = 25 °C)

| XLamp XP-G LED Standard Kit Codes - White | | | | | | |
|---|--------|--------------------------------------|-----------|----------------------|----------------------|----------------|
| Chromaticity | | Minimum Luminous Flux (lm) @ 350 mA* | | Order Codes | | |
| Kit | CCT | Code | Flux (lm) | 70 CRI Typical | 75 CRI Typical | 80 CRI Minimum |
| ANSI Neutral White (3700 K – 5000 K) | | | | | | |
| E3 | 5000 K | R5 | 139 | XPGWHT-01-0000-00HE3 | | |
| | | R4 | 130 | XPGWHT-01-0000-00GE3 | | |
| | | R3 | 122 | XPGWHT-01-0000-00FE3 | XPGWHT-L1-0000-00FE3 | |
| | | R2 | 114 | XPGWHT-01-0000-00EE3 | XPGWHT-L1-0000-00EE3 | |
| | | Q5 | 107 | | XPGWHT-L1-0000-00DE3 | |
| C1 | 5000 K | R5 | 139 | XPGWHT-01-0000-00HC1 | | |
| | | R4 | 130 | XPGWHT-01-0000-00GC1 | | |
| | | R3 | 122 | XPGWHT-01-0000-00FC1 | | |
| | | R2 | 114 | XPGWHT-01-0000-00EC1 | | |
| F4 | 4750 K | R5 | 139 | XPGWHT-01-0000-00HF4 | | |
| | | R4 | 130 | XPGWHT-01-0000-00GF4 | | |
| | | R3 | 122 | XPGWHT-01-0000-00FF4 | XPGWHT-L1-0000-00FF4 | |
| | | R2 | 114 | XPGWHT-01-0000-00EF4 | XPGWHT-L1-0000-00EF4 | |
| | | Q5 | 107 | | XPGWHT-L1-0000-00DF4 | |
| D1 | 4750 K | R5 | 139 | XPGWHT-01-0000-00HD1 | | |
| | | R4 | 130 | XPGWHT-01-0000-00GD1 | | |
| | | R3 | 122 | XPGWHT-01-0000-00FD1 | | |
| | | R2 | 114 | XPGWHT-01-0000-00ED1 | | |
| E4 | 4500 K | R5 | 139 | XPGWHT-01-0000-00HE4 | | |
| | | R4 | 130 | XPGWHT-01-0000-00GE4 | | |
| | | R3 | 122 | XPGWHT-01-0000-00FE4 | XPGWHT-L1-0000-00FE4 | |
| | | R2 | 114 | XPGWHT-01-0000-00EE4 | XPGWHT-L1-0000-00EE4 | |
| | | Q5 | 107 | | XPGWHT-L1-0000-00DE4 | |
| D2 | 4500 K | R5 | 139 | XPGWHT-01-0000-00HD2 | | |
| | | R4 | 130 | XPGWHT-01-0000-00GD2 | | |
| | | R3 | 122 | XPGWHT-01-0000-00FD2 | | |
| | | R2 | 114 | XPGWHT-01-0000-00ED2 | | |
| C2 | 4500 K | R5 | 139 | XPGWHT-01-0000-00HC2 | | |
| | | R4 | 130 | XPGWHT-01-0000-00GC2 | | |
| | | R3 | 122 | XPGWHT-01-0000-00FC2 | | |
| | | R2 | 114 | XPGWHT-01-0000-00EC2 | | |
| C3 | 4300 K | R4 | 130 | XPGWHT-01-0000-00GC3 | | |
| | | R3 | 122 | XPGWHT-01-0000-00FC3 | | |
| D3 | 4300 K | R4 | 130 | XPGWHT-01-0000-00GD3 | | |
| | | R3 | 122 | XPGWHT-01-0000-00FD3 | | |
| | | R2 | 114 | XPGWHT-01-0000-00ED3 | | |

* Cree XLamp XP Family LED order codes specify only a minimum flux bin and not a maximum. Cree may ship reels in flux bins higher than the minimum specified by the order code without advance notice. Shipments will always adhere to the chromaticity or DWL bin restrictions specified by the order code.

STANDARD ORDER CODES AND BINS (XP-G NEUTRAL WHITE, OUTDOOR WHITE, T_j = 25 °C, CONTINUED)

| XLamp XP-G LED Standard Kit Codes - White | | | | | | |
|---|--------|--------------------------------------|-----------|----------------------|----------------------|----------------------|
| Chromaticity | | Minimum Luminous Flux (lm) @ 350 mA* | | Order Codes | | |
| Kit | CCT | Code | Flux (lm) | 70 CRI Typical | 75 CRI Typical | 80 CRI Minimum |
| ANSI Neutral White (3700 K – 5000 K) | | | | | | |
| F5 | 4250 K | R4 | 130 | XPGWHT-01-0000-00GF5 | | |
| | | R3 | 122 | XPGWHT-01-0000-00FF5 | XPGWHT-L1-0000-00FF5 | |
| | | R2 | 114 | XPGWHT-01-0000-00EF5 | XPGWHT-L1-0000-00EF5 | |
| | | Q5 | 107 | | XPGWHT-L1-0000-00DF5 | |
| C4 | 4100 K | R3 | 122 | XPGWHT-01-0000-00FC4 | | |
| | | R2 | 114 | XPGWHT-01-0000-00EC4 | | |
| | | Q5 | 107 | XPGWHT-01-0000-00DC4 | | |
| D4 | 4000 K | R3 | 122 | XPGWHT-01-0000-00FD4 | | |
| | | R2 | 114 | XPGWHT-01-0000-00ED4 | | |
| | | Q5 | 107 | XPGWHT-01-0000-00DD4 | | |
| E5 | 4000 K | R4 | 130 | XPGWHT-01-0000-00GE5 | | |
| | | R3 | 122 | XPGWHT-01-0000-00FE5 | XPGWHT-L1-0000-00FE5 | |
| | | R2 | 114 | XPGWHT-01-0000-00EE5 | XPGWHT-L1-0000-00EE5 | XPGWHT-H1-0000-00EE5 |
| | | Q5 | 107 | | XPGWHT-L1-0000-00DE5 | XPGWHT-H1-0000-00DE5 |
| Z5 | 4000 K | R2 | 114 | | XPGWHT-L1-0000-00EZ5 | XPGWHT-H1-0000-00EZ5 |
| | | Q5 | 107 | | XPGWHT-L1-0000-00DZ5 | XPGWHT-H1-0000-00DZ5 |
| C5 | 3800 K | R3 | 122 | XPGWHT-01-0000-00FC5 | | |
| | | R2 | 114 | XPGWHT-01-0000-00EC5 | | |
| | | Q5 | 107 | XPGWHT-01-0000-00DC5 | | |

* Cree XLamp XP Family LED order codes specify only a minimum flux bin and not a maximum. Cree may ship reels in flux bins higher than the minimum specified by the order code without advance notice. Shipments will always adhere to the chromaticity or DWL bin restrictions specified by the order code.

STANDARD ORDER CODES AND BINS (XP-G WARM WHITE, T_j = 25 °C)

| XLamp XP-G LED Standard Kit Codes - White | | | | | | | | |
|---|--------|--------------------------------------|-----------|----------------------|----------------------|----------------------|----------------------|----------------------|
| Chromaticity | | Minimum Luminous Flux (lm) @ 350 mA* | | Order Codes | | | | |
| Kit | CCT | Code | Flux (lm) | 70 CRI Typical | 80 CRI Typical | 80 CRI Minimum | 85 CRI Minimum | 90 CRI Minimum |
| ANSI Warm White (2700 K - 3750 K) | | | | | | | | |
| F6 | 3750 K | R3 | 122 | XPGWHT-01-0000-00FF6 | | | | |
| | | R2 | 114 | XPGWHT-01-0000-00EF6 | XPGWHT-L1-0000-00EF6 | XPGWHT-H1-0000-00EF6 | | |
| | | Q5 | 107 | XPGWHT-01-0000-00DF6 | XPGWHT-L1-0000-00DF6 | XPGWHT-H1-0000-00DF6 | | |
| | | Q4 | 100 | | XPGWHT-L1-0000-00CF6 | XPGWHT-H1-0000-00CF6 | | |
| D5 | 3700 K | R3 | 122 | XPGWHT-01-0000-00FD5 | | | | |
| | | R2 | 114 | XPGWHT-01-0000-00ED5 | | | | |
| | | Q5 | 107 | XPGWHT-01-0000-00DD5 | | | | |
| C6 | 3600 K | R3 | 122 | XPGWHT-01-0000-00FC6 | | | | |
| | | R2 | 114 | XPGWHT-01-0000-00EC6 | | | | |
| | | Q5 | 107 | XPGWHT-01-0000-00DC6 | | | | |
| E6 | 3500 K | R3 | 122 | XPGWHT-01-0000-00FE6 | | | | |
| | | R2 | 114 | XPGWHT-01-0000-00EE6 | XPGWHT-L1-0000-00EE6 | | | |
| | | Q5 | 107 | XPGWHT-01-0000-00DE6 | XPGWHT-L1-0000-00DE6 | XPGWHT-H1-0000-00DE6 | | |
| | | Q4 | 100 | | XPGWHT-L1-0000-00CE6 | XPGWHT-H1-0000-00CE6 | | |
| Z6 | 3500 K | Q5 | 107 | | XPGWHT-L1-0000-00DZ6 | XPGWHT-H1-0000-00DZ6 | | |
| | | Q4 | 100 | | XPGWHT-L1-0000-00CZ6 | XPGWHT-H1-0000-00CZ6 | | |
| F7 | 3250 K | R2 | 114 | | XPGWHT-L1-0000-00EF7 | | | |
| | | Q5 | 107 | | XPGWHT-L1-0000-00DF7 | XPGWHT-H1-0000-00DF7 | | |
| | | Q4 | 100 | | XPGWHT-L1-0000-00CF7 | XPGWHT-H1-0000-00CF7 | | |
| | | Q3 | 93.9 | | XPGWHT-L1-0000-00BF7 | XPGWHT-H1-0000-00BF7 | | |
| E7 | 3000 K | R2 | 114 | | XPGWHT-L1-0000-00EE7 | | | |
| | | Q5 | 107 | | XPGWHT-L1-0000-00DE7 | XPGWHT-H1-0000-00DE7 | | |
| | | Q4 | 100 | | XPGWHT-L1-0000-00CE7 | XPGWHT-H1-0000-00CE7 | | |
| | | Q3 | 93.9 | | XPGWHT-L1-0000-00BE7 | XPGWHT-H1-0000-00BE7 | XPGWHT-P1-0000-00BE7 | |
| | | Q2 | 87.4 | | | | XPGWHT-P1-0000-00AE7 | XPGWHT-U1-0000-00AE7 |
| | | P4 | 80.6 | | | | XPGWHT-P1-0000-009E7 | XPGWHT-U1-0000-009E7 |
| | | P3 | 73.9 | | | | XPGWHT-P1-0000-008E7 | XPGWHT-U1-0000-008E7 |
| Z7 | 3000 K | Q5 | 107 | | XPGWHT-L1-0000-00DZ7 | XPGWHT-H1-0000-00DZ7 | | |
| | | Q4 | 100 | | XPGWHT-L1-0000-00CZ7 | XPGWHT-H1-0000-00CZ7 | | |
| | | Q3 | 93.9 | | XPGWHT-L1-0000-00BZ7 | XPGWHT-H1-0000-00BZ7 | | |
| | | Q2 | 87.4 | | | | XPGWHT-P1-0000-00AZ7 | |
| | | P4 | 80.6 | | | | XPGWHT-P1-0000-009Z7 | XPGWHT-U1-0000-009Z7 |
| | | P3 | 73.9 | | | | XPGWHT-P1-0000-008Z7 | XPGWHT-U1-0000-008Z7 |
| F8 | 2850 K | Q5 | 107 | | XPGWHT-L1-0000-00DF8 | | | |
| | | Q4 | 100 | | XPGWHT-L1-0000-00CF8 | XPGWHT-H1-0000-00CF8 | | |
| | | Q3 | 93.9 | | XPGWHT-L1-0000-00BF8 | XPGWHT-H1-0000-00BF8 | | |
| | | Q2 | 87.4 | | XPGWHT-L1-0000-00AF8 | XPGWHT-H1-0000-00AF8 | XPGWHT-P1-0000-00AF8 | |
| | | P4 | 80.6 | | | | XPGWHT-P1-0000-009F8 | XPGWHT-U1-0000-009F8 |
| | | P3 | 73.9 | | | | XPGWHT-P1-0000-008F8 | XPGWHT-U1-0000-008F8 |
| | | P2 | 67.2 | | | | XPGWHT-P1-0000-007F8 | XPGWHT-U1-0000-007F8 |

* Cree XLamp XP Family LED order codes specify only a minimum flux bin and not a maximum. Cree may ship reels in flux bins higher than the minimum specified by the order code without advance notice. Shipments will always adhere to the chromaticity or DWL bin restrictions specified by the order code.

STANDARD ORDER CODES AND BINS (XP-G WARM WHITE, T_j = 25 °C, CONTINUED)

| XLamp XP-G LED Standard Kit Codes - White | | | | | | | | |
|---|--------|--------------------------------------|-----------|----------------|----------------------|----------------------|----------------------|----------------------|
| Chromaticity | | Minimum Luminous Flux (lm) @ 350 mA* | | Order Codes | | | | |
| Kit | CCT | Code | Flux (lm) | 70 CRI Typical | 80 CRI Typical | 80 CRI Minimum | 85 CRI Minimum | 90 CRI Minimum |
| ANSI Warm White (2700 K - 3750 K) | | | | | | | | |
| E8 | 2700 K | Q5 | 107 | | XPGWHT-L1-0000-00DE8 | | | |
| | | Q4 | 100 | | XPGWHT-L1-0000-00CE8 | XPGWHT-H1-0000-00CE8 | | |
| | | Q3 | 93.9 | | XPGWHT-L1-0000-00BE8 | XPGWHT-H1-0000-00BE8 | | |
| | | Q2 | 87.4 | | XPGWHT-L1-0000-00AE8 | XPGWHT-H1-0000-00AE8 | XPGWHT-P1-0000-00AE8 | |
| | | P4 | 80.6 | | | | XPGWHT-P1-0000-009E8 | XPGWHT-U1-0000-009E8 |
| | | P3 | 73.9 | | | | XPGWHT-P1-0000-008E8 | XPGWHT-U1-0000-008E8 |
| | | P2 | 67.2 | | | | XPGWHT-P1-0000-007E8 | XPGWHT-U1-0000-007E8 |
| Z8 | 2700 K | Q4 | 100 | | XPGWHT-L1-0000-00CZ8 | XPGWHT-H1-0000-00CZ8 | | |
| | | Q3 | 93.9 | | XPGWHT-L1-0000-00BZ8 | XPGWHT-H1-0000-00BZ8 | | |
| | | Q2 | 87.4 | | XPGWHT-L1-0000-00AZ8 | XPGWHT-H1-0000-00AZ8 | | |
| | | P4 | 80.6 | | | | XPGWHT-P1-0000-009Z8 | |
| | | P3 | 73.9 | | | | XPGWHT-P1-0000-008Z8 | XPGWHT-U1-0000-008Z8 |
| | | P2 | 67.2 | | | | XPGWHT-P1-0000-007Z8 | XPGWHT-U1-0000-007Z8 |

* Cree XLamp XP Family LED order codes specify only a minimum flux bin and not a maximum. Cree may ship reels in flux bins higher than the minimum specified by the order code without advance notice. Shipments will always adhere to the chromaticity or DWL bin restrictions specified by the order code.

STANDARD ORDER CODES AND BINS (XP-G2 ANSI COOL WHITE, T_j = 85 °C)

| XLamp XP-G2 LED Standard Order Codes - White | | | | |
|--|--------|--------------------------------------|-----------|----------------------|
| Chromaticity | | Minimum Luminous Flux (lm) @ 350 mA* | | Order Cdes |
| Kit | CCT | Code | Flux (lm) | 70 CRI Typical |
| ANSI Cool White (5000 K – 8300 K) | | | | |
| 51 | 6200 K | S2 | 148 | XPGBWT-L1-0000-00J51 |
| | | R5 | 139 | XPGBWT-L1-0000-00H51 |
| | | R4 | 130 | XPGBWT-L1-0000-00G51 |
| | | R3 | 122 | XPGBWT-L1-0000-00F51 |
| 53 | 6000 K | S2 | 148 | XPGBWT-L1-0000-00J53 |
| | | R5 | 139 | XPGBWT-L1-0000-00H53 |
| | | R4 | 130 | XPGBWT-L1-0000-00G53 |
| | | R3 | 122 | XPGBWT-L1-0000-00F53 |
| 50 | 6200 K | S2 | 148 | XPGBWT-L1-0000-00J50 |
| | | R5 | 139 | XPGBWT-L1-0000-00H50 |
| | | R4 | 130 | XPGBWT-L1-0000-00G50 |
| | | R3 | 122 | XPGBWT-L1-0000-00F50 |
| E1 | 6500 K | S2 | 148 | XPGBWT-L1-0000-00JE1 |
| | | R5 | 139 | XPGBWT-L1-0000-00HE1 |
| | | R4 | 130 | XPGBWT-L1-0000-00GE1 |
| | | R3 | 122 | XPGBWT-L1-0000-00FE1 |
| E2 | 5700 K | S2 | 148 | XPGBWT-L1-0000-00JE2 |
| | | R5 | 139 | XPGBWT-L1-0000-00HE2 |
| | | R4 | 130 | XPGBWT-L1-0000-00GE2 |
| | | R3 | 122 | XPGBWT-L1-0000-00FE2 |

* Cree XLamp XP Family LED order codes specify only a minimum flux bin and not a maximum. Cree may ship reels in flux bins higher than the minimum specified by the order code without advance notice. Shipments will always adhere to the chromaticity or DWL bin restrictions specified by the order code.

STANDARD ORDER CODES AND BINS (XP-G2 NEUTRAL WHITE, OUTDOOR WHITE, T_j = 85 °C)

| XLamp XP-G2 LED Standard Kit Codes - White | | | | | | |
|--|--------|--------------------------------------|-----------|----------------------|----------------------|----------------|
| Chromaticity | | Minimum Luminous Flux (lm) @ 350 mA* | | Order Codes | | |
| Kit | CCT | Code | Flux (lm) | 70 CRI Typical | 75 CRI Typical | 80 CRI Minimum |
| ANSI Neutral White (3700 K – 5000 K) | | | | | | |
| E3 | 5000 K | R5 | 139 | XPGBWT-01-0000-00HE3 | | |
| | | R4 | 130 | XPGBWT-01-0000-00GE3 | XPGBWT-L1-0000-00GE3 | |
| | | R3 | 122 | XPGBWT-01-0000-00FE3 | XPGBWT-L1-0000-00FE3 | |
| | | R2 | 114 | XPGBWT-01-0000-00EE3 | XPGBWT-L1-0000-00EE3 | |
| | | Q5 | 107 | | XPGBWT-L1-0000-00DE3 | |
| C1 | 5000 K | R5 | 139 | XPGBWT-01-0000-00HC1 | | |
| | | R4 | 130 | XPGBWT-01-0000-00GC1 | | |
| | | R3 | 122 | XPGBWT-01-0000-00FC1 | | |
| | | R2 | 114 | XPGBWT-01-0000-00EC1 | | |
| F4 | 4750 K | R5 | 139 | XPGBWT-01-0000-00HF4 | | |
| | | R4 | 130 | XPGBWT-01-0000-00GF4 | XPGBWT-L1-0000-00GF4 | |
| | | R3 | 122 | XPGBWT-01-0000-00FF4 | XPGBWT-L1-0000-00FF4 | |
| | | R2 | 114 | XPGBWT-01-0000-00EF4 | XPGBWT-L1-0000-00EF4 | |
| | | Q5 | 107 | | XPGBWT-L1-0000-00DF4 | |
| D1 | 4750 K | R5 | 139 | XPGBWT-01-0000-00HD1 | | |
| | | R4 | 130 | XPGBWT-01-0000-00GD1 | | |
| | | R3 | 122 | XPGBWT-01-0000-00FD1 | | |
| | | R2 | 114 | XPGBWT-01-0000-00ED1 | | |
| E4 | 4500 K | R5 | 139 | XPGBWT-01-0000-00HE4 | | |
| | | R4 | 130 | XPGBWT-01-0000-00GE4 | XPGBWT-L1-0000-00GE4 | |
| | | R3 | 122 | XPGBWT-01-0000-00FE4 | XPGBWT-L1-0000-00FE4 | |
| | | R2 | 114 | XPGBWT-01-0000-00EE4 | XPGBWT-L1-0000-00EE4 | |
| | | Q5 | 107 | | XPGBWT-L1-0000-00DE4 | |
| D2 | 4500 K | R5 | 139 | XPGBWT-01-0000-00HD2 | | |
| | | R4 | 130 | XPGBWT-01-0000-00GD2 | | |
| | | R3 | 122 | XPGBWT-01-0000-00FD2 | | |
| | | R2 | 114 | XPGBWT-01-0000-00ED2 | | |
| C2 | 4500 K | R5 | 139 | XPGBWT-01-0000-00HC2 | | |
| | | R4 | 130 | XPGBWT-01-0000-00GC2 | | |
| | | R3 | 122 | XPGBWT-01-0000-00FC2 | | |
| | | R2 | 114 | XPGBWT-01-0000-00EC2 | | |
| C3 | 4300 K | R5 | 139 | XPGBWT-01-0000-00HC3 | | |
| | | R4 | 130 | XPGBWT-01-0000-00GC3 | | |
| | | R3 | 122 | XPGBWT-01-0000-00FC3 | | |
| | | R2 | 114 | XPGBWT-01-0000-00EC3 | | |
| D3 | 4300 K | R5 | 139 | XPGBWT-01-0000-00HD3 | | |
| | | R4 | 130 | XPGBWT-01-0000-00GD3 | | |
| | | R3 | 122 | XPGBWT-01-0000-00FD3 | | |
| | | R2 | 114 | XPGBWT-01-0000-00ED3 | | |

* Cree XLamp XP Family LED order codes specify only a minimum flux bin and not a maximum. Cree may ship reels in flux bins higher than the minimum specified by the order code without advance notice. Shipments will always adhere to the chromaticity or DWL bin restrictions specified by the order code.

STANDARD ORDER CODES AND BINS (XP-G2 NEUTRAL WHITE, OUTDOOR WHITE, T_j = 85 °C, CONTINUED)

| XLamp XP-G2 LED Standard Kit Codes - White | | | | | | |
|--|--------|--------------------------------------|-----------|----------------------|----------------------|----------------------|
| Chromaticity | | Minimum Luminous Flux (lm) @ 350 mA* | | Order Codes | | |
| Kit | CCT | Code | Flux (lm) | 70 CRI Typical | 75 CRI Typical | 80 CRI Minimum |
| ANSI Neutral White (3700 K – 5000 K) | | | | | | |
| F5 | 4250 K | R5 | 139 | XPGBWT-01-0000-00HF5 | | |
| | | R4 | 130 | XPGBWT-01-0000-00GF5 | XPGBWT-L1-0000-00GF5 | |
| | | R3 | 122 | XPGBWT-01-0000-00FF5 | XPGBWT-L1-0000-00FF5 | |
| | | R2 | 114 | XPGBWT-01-0000-00EF5 | XPGBWT-L1-0000-00EF5 | |
| | | Q5 | 107 | | XPGBWT-L1-0000-00DF5 | |
| C4 | 4100 K | R5 | 139 | XPGBWT-01-0000-00HC4 | | |
| | | R4 | 130 | XPGBWT-01-0000-00GC4 | | |
| | | R3 | 122 | XPGBWT-01-0000-00FC4 | | |
| | | R2 | 114 | XPGBWT-01-0000-00EC4 | | |
| D4 | 4000 K | R5 | 139 | XPGBWT-01-0000-00HD4 | | |
| | | R4 | 130 | XPGBWT-01-0000-00GD4 | | |
| | | R3 | 122 | XPGBWT-01-0000-00FD4 | | |
| | | R2 | 114 | XPGBWT-01-0000-00ED4 | | |
| E5 | 4000 K | R5 | 139 | XPGBWT-01-0000-00HE5 | | |
| | | R4 | 130 | XPGBWT-01-0000-00GE5 | XPGBWT-L1-0000-00GE5 | |
| | | R3 | 122 | XPGBWT-01-0000-00FE5 | XPGBWT-L1-0000-00FE5 | XPGBWT-H1-0000-00FE5 |
| | | R2 | 114 | XPGBWT-01-0000-00EE5 | XPGBWT-L1-0000-00EE5 | XPGBWT-H1-0000-00EE5 |
| | | Q5 | 107 | | XPGBWT-L1-0000-00DE5 | XPGBWT-H1-0000-00DE5 |
| Z5 | 4000 K | R3 | 122 | | XPGBWT-L1-0000-00FZ5 | XPGBWT-H1-0000-00FZ5 |
| | | R2 | 114 | | XPGBWT-L1-0000-00EZ5 | XPGBWT-H1-0000-00EZ5 |
| | | Q5 | 107 | | XPGBWT-L1-0000-00DZ5 | XPGBWT-H1-0000-00DZ5 |
| C5 | 3800 K | R5 | 139 | XPGBWT-01-0000-00HC5 | | |
| | | R4 | 130 | XPGBWT-01-0000-00GC5 | | |
| | | R3 | 122 | XPGBWT-01-0000-00FC5 | | |
| | | R2 | 114 | XPGBWT-01-0000-00EC5 | | |
| | | Q5 | 107 | XPGBWT-01-0000-00DC5 | | |

* Cree XLamp XP Family LED order codes specify only a minimum flux bin and not a maximum. Cree may ship reels in flux bins higher than the minimum specified by the order code without advance notice. Shipments will always adhere to the chromaticity or DWL bin restrictions specified by the order code.

STANDARD ORDER CODES AND BINS (XP-G2 WARM WHITE, T_j = 85 °C)

| XLamp XP-G2 LED Standard Kit Codes - White | | | | | | | | |
|--|--------|--------------------------------------|-----------|----------------------|----------------------|----------------------|----------------------|----------------------|
| Chromaticity | | Minimum Luminous Flux (lm) @ 350 mA* | | Order Codes | | | | |
| Kit | CCT | Code | Flux (lm) | 70 CRI Typical | 80 CRI Typical | 80 CRI Minimum | 85 CRI Minimum | 90 CRI Minimum |
| ANSI Warm White (2700 K - 3750 K) | | | | | | | | |
| F6 | 3750 K | R5 | 139 | XPGBWT-01-0000-00HF6 | | | | |
| | | R4 | 130 | XPGBWT-01-0000-00GF6 | XPGBWT-L1-0000-00GF6 | XPGBWT-H1-0000-00GF6 | | |
| | | R3 | 122 | XPGBWT-01-0000-00FF6 | XPGBWT-L1-0000-00FF6 | XPGBWT-H1-0000-00FF6 | | |
| | | R2 | 114 | XPGBWT-01-0000-00EF6 | XPGBWT-L1-0000-00EF6 | XPGBWT-H1-0000-00EF6 | | |
| | | Q5 | 107 | XPGBWT-01-0000-00DF6 | XPGBWT-L1-0000-00DF6 | XPGBWT-H1-0000-00DF6 | | |
| D5 | 3700 K | R4 | 130 | XPGBWT-01-0000-00GD5 | | | | |
| | | R3 | 122 | XPGBWT-01-0000-00FD5 | | | | |
| | | R2 | 114 | XPGBWT-01-0000-00ED5 | | | | |
| | | Q5 | 107 | XPGBWT-01-0000-00DD5 | | | | |
| C6 | 3600 K | R4 | 130 | XPGBWT-01-0000-00GC6 | | | | |
| | | R3 | 122 | XPGBWT-01-0000-00FC6 | | | | |
| | | R2 | 114 | XPGBWT-01-0000-00EC6 | | | | |
| | | Q5 | 107 | XPGBWT-01-0000-00DC6 | | | | |
| E6 | 3500 K | R4 | 130 | XPGBWT-01-0000-00GE6 | XPGBWT-L1-0000-00GE6 | XPGBWT-H1-0000-00GE6 | | |
| | | R3 | 122 | XPGBWT-01-0000-00FE6 | XPGBWT-L1-0000-00FE6 | XPGBWT-H1-0000-00FE6 | | |
| | | R2 | 114 | XPGBWT-01-0000-00EE6 | XPGBWT-L1-0000-00EE6 | XPGBWT-H1-0000-00EE6 | | |
| | | Q5 | 107 | XPGBWT-01-0000-00DE6 | XPGBWT-L1-0000-00DE6 | XPGBWT-H1-0000-00DE6 | | |
| Z6 | 3500 K | R3 | 122 | | XPGBWT-L1-0000-00FZ6 | XPGBWT-H1-0000-00FZ6 | | |
| | | R2 | 114 | | XPGBWT-L1-0000-00EZ6 | XPGBWT-H1-0000-00EZ6 | | |
| | | Q5 | 107 | | XPGBWT-L1-0000-00DZ6 | XPGBWT-H1-0000-00DZ6 | | |
| F7 | 3250 K | R4 | 130 | | XPGBWT-L1-0000-00GF7 | XPGBWT-H1-0000-00GF7 | | |
| | | R3 | 122 | | XPGBWT-L1-0000-00FF7 | XPGBWT-H1-0000-00FF7 | | |
| | | R2 | 114 | | XPGBWT-L1-0000-00EF7 | XPGBWT-H1-0000-00EF7 | | |
| | | Q5 | 107 | | XPGBWT-L1-0000-00DF7 | XPGBWT-H1-0000-00DF7 | | |
| | | Q4 | 100 | | | XPGBWT-H1-0000-00CF7 | | |
| E7 | 3000 K | R4 | 130 | XPGBWT-01-0000-00GE7 | XPGBWT-L1-0000-00GE7 | XPGBWT-H1-0000-00GE7 | | |
| | | R3 | 122 | XPGBWT-01-0000-00FE7 | XPGBWT-L1-0000-00FE7 | XPGBWT-H1-0000-00FE7 | | |
| | | R2 | 114 | XPGBWT-01-0000-00EE7 | XPGBWT-L1-0000-00EE7 | XPGBWT-H1-0000-00EE7 | | |
| | | Q5 | 107 | | XPGBWT-L1-0000-00DE7 | XPGBWT-H1-0000-00DE7 | | |
| | | Q4 | 100 | | XPGBWT-L1-0000-00CE7 | XPGBWT-H1-0000-00CE7 | | |
| | | Q3 | 93.9 | | | | XPGBWT-P1-0000-00BE7 | XPGBWT-U1-0000-00BE7 |
| | | Q2 | 87.4 | | | | XPGBWT-P1-0000-00AE7 | XPGBWT-U1-0000-00AE7 |
| | | P4 | 80.6 | | | | XPGBWT-P1-0000-009E7 | XPGBWT-U1-0000-009E7 |
| | | P3 | 73.9 | | | | XPGBWT-P1-0000-008E7 | XPGBWT-U1-0000-008E7 |

* Cree XLamp XP Family LED order codes specify only a minimum flux bin and not a maximum. Cree may ship reels in flux bins higher than the minimum specified by the order code without advance notice. Shipments will always adhere to the chromaticity or DWL bin restrictions specified by the order code.

STANDARD ORDER CODES AND BINS (XP-G2 WARM WHITE T_j = 85 °C, CONTINUED)

| XLamp XP-G2 LED Standard Kit Codes - White | | | | | | | | |
|--|--------|--------------------------------------|-----------|----------------|----------------------|----------------------|----------------------|----------------------|
| Chromaticity | | Minimum Luminous Flux (lm) @ 350 mA* | | Order Codes | | | | |
| Kit | CCT | Code | Flux (lm) | 70 CRI Typical | 80 CRI Typical | 80 CRI Minimum | 85 CRI Minimum | 90 CRI Minimum |
| ANSI Warm White (2700 K - 3750 K) | | | | | | | | |
| Z7 | 3000 K | R3 | 122 | | XPGBWT-L1-0000-00FZ7 | XPGBWT-H1-0000-00FZ7 | | |
| | | R2 | 114 | | XPGBWT-L1-0000-00EZ7 | XPGBWT-H1-0000-00EZ7 | | |
| | | Q5 | 107 | | XPGBWT-L1-0000-00DZ7 | XPGBWT-H1-0000-00DZ7 | | |
| | | Q4 | 100 | | XPGBWT-L1-0000-00CZ7 | XPGBWT-H1-0000-00CZ7 | | |
| | | Q3 | 93.9 | | | | | |
| | | Q2 | 87.4 | | | | XPGBWT-P1-0000-00AZ7 | XPGBWT-U1-0000-00AZ7 |
| | | P4 | 80.6 | | | | XPGBWT-P1-0000-009Z7 | XPGBWT-U1-0000-009Z7 |
| | | P3 | 73.9 | | | | XPGBWT-P1-0000-008Z7 | XPGBWT-U1-0000-008Z7 |
| F8 | 2850 K | R2 | 114 | | XPGBWT-L1-0000-00EF8 | XPGBWT-H1-0000-00EF8 | | |
| | | Q5 | 107 | | XPGBWT-L1-0000-00DF8 | XPGBWT-H1-0000-00DF8 | | |
| | | Q4 | 100 | | XPGBWT-L1-0000-00CF8 | XPGBWT-H1-0000-00CF8 | | |
| | | Q3 | 93.9 | | XPGBWT-L1-0000-00BF8 | XPGBWT-H1-0000-00BF8 | XPGBWT-P1-0000-00BF8 | |
| | | Q2 | 87.4 | | | | XPGBWT-P1-0000-00AF8 | XPGBWT-U1-0000-00AF8 |
| | | P4 | 80.6 | | | | XPGBWT-P1-0000-009F8 | XPGBWT-U1-0000-009F8 |
| | | P3 | 73.9 | | | | XPGBWT-P1-0000-008F8 | XPGBWT-U1-0000-008F8 |
| | | P2 | 67.2 | | | | XPGBWT-P1-0000-007F8 | XPGBWT-U1-0000-007F8 |
| E8 | 2700 K | R3 | 122 | | XPGBWT-L1-0000-00FE8 | XPGBWT-H1-0000-00FE8 | | |
| | | R2 | 114 | | XPGBWT-L1-0000-00EE8 | XPGBWT-H1-0000-00EE8 | | |
| | | Q5 | 107 | | XPGBWT-L1-0000-00DE8 | XPGBWT-H1-0000-00DE8 | | |
| | | Q4 | 100 | | XPGBWT-L1-0000-00CE8 | XPGBWT-H1-0000-00CE8 | | |
| | | Q3 | 93.9 | | XPGBWT-L1-0000-00BE8 | XPGBWT-H1-0000-00BE8 | | |
| | | Q2 | 87.4 | | | | XPGBWT-P1-0000-00AE8 | XPGBWT-U1-0000-00AE8 |
| | | P4 | 80.6 | | | | XPGBWT-P1-0000-009E8 | XPGBWT-U1-0000-009E8 |
| | | P3 | 73.9 | | | | XPGBWT-P1-0000-008E8 | XPGBWT-U1-0000-008E8 |
| Z8 | 2700 K | R2 | 114 | | XPGBWT-L1-0000-00EZ8 | XPGBWT-H1-0000-00EZ8 | | |
| | | Q5 | 107 | | XPGBWT-L1-0000-00DZ8 | XPGBWT-H1-0000-00DZ8 | | |
| | | Q4 | 100 | | XPGBWT-L1-0000-00CZ8 | XPGBWT-H1-0000-00CZ8 | | |
| | | Q3 | 93.9 | | XPGBWT-L1-0000-00BZ8 | XPGBWT-H1-0000-00BZ8 | | |
| | | Q2 | 87.4 | | | | | |
| | | P4 | 80.6 | | | | XPGBWT-P1-0000-009Z8 | XPGBWT-U1-0000-009Z8 |
| | | P3 | 73.9 | | | | XPGBWT-P1-0000-008Z8 | XPGBWT-U1-0000-008Z8 |
| | | P2 | 67.2 | | | | XPGBWT-P1-0000-007Z8 | XPGBWT-U1-0000-007Z8 |

* Cree XLamp XP Family LED order codes specify only a minimum flux bin and not a maximum. Cree may ship reels in flux bins higher than the minimum specified by the order code without advance notice. Shipments will always adhere to the chromaticity or DWL bin restrictions specified by the order code.

STANDARD ORDER CODES AND BINS (XP-L ANSI COOL WHITE, $T_j = 85\text{ }^\circ\text{C}$)

| XLamp XP-L LED Standard Order Codes - White | | | | |
|---|--------|---------------------------------------|-----------|--------------------------|
| Chromaticity | | Minimum Luminous Flux (lm) @ 1050 mA* | | Order Cdes |
| Kit | CCT | Code | Flux (lm) | 65 CRI Typical |
| ANSI Cool White (5000 K – 8300 K) | | | | |
| 51 | 6200 K | V5 | 460 | XPLAWT-00-0000-0000V5051 |
| | | V4 | 440 | XPLAWT-00-0000-0000V4051 |
| | | V3 | 420 | XPLAWT-00-0000-0000V3051 |
| 53 | 6000 K | V5 | 460 | XPLAWT-00-0000-0000V5053 |
| | | V4 | 440 | XPLAWT-00-0000-0000V4053 |
| | | V3 | 420 | XPLAWT-00-0000-0000V3053 |
| 50 | 6200 K | V5 | 460 | XPLAWT-00-0000-0000V5050 |
| | | V4 | 440 | XPLAWT-00-0000-0000V4050 |
| | | V3 | 420 | XPLAWT-00-0000-0000V3050 |
| E1 | 6500 K | V5 | 460 | XPLAWT-00-0000-0000V50E1 |
| | | V4 | 440 | XPLAWT-00-0000-0000V40E1 |
| | | V3 | 420 | XPLAWT-00-0000-0000V30E1 |
| E2 | 5700 K | V5 | 460 | XPLAWT-00-0000-0000V50E2 |
| | | V4 | 440 | XPLAWT-00-0000-0000V40E2 |
| | | V3 | 420 | XPLAWT-00-0000-0000V30E2 |

* Cree XLamp XP Family LED order codes specify only a minimum flux bin and not a maximum. Cree may ship reels in flux bins higher than the minimum specified by the order code without advance notice. Shipments will always adhere to the chromaticity or DWL bin restrictions specified by the order code.

STANDARD ORDER CODES AND BINS (XP-L NEUTRAL WHITE, T_j = 85 °C)

| XLamp XP-L LED Standard Kit Codes - White | | | | | | |
|---|--------|---------------------------------------|-----------|--------------------------|--------------------------|--------------------------|
| Chromaticity | | Minimum Luminous Flux (lm) @ 1050 mA* | | Order Codes | | |
| Kit | CCT | Code | Flux (lm) | 70 CRI Minimum | 75 CRI Typical | 80 CRI Minimum |
| ANSI Neutral White (3700 K – 5000 K) | | | | | | |
| E3 | 5000 K | V4 | 440 | XPLAWT-00-0000-000BV40E3 | XPLAWT-00-0000-000LV40E3 | |
| | | V3 | 420 | XPLAWT-00-0000-000BV30E3 | XPLAWT-00-0000-000LV30E3 | |
| | | V2 | 400 | XPLAWT-00-0000-000BV20E3 | XPLAWT-00-0000-000LV20E3 | |
| F4 | 4750 K | V4 | 440 | XPLAWT-00-0000-000BV40F4 | XPLAWT-00-0000-000LV40F4 | |
| | | V3 | 420 | XPLAWT-00-0000-000BV30F4 | XPLAWT-00-0000-000LV30F4 | |
| | | V2 | 400 | XPLAWT-00-0000-000BV20F4 | XPLAWT-00-0000-000LV20F4 | |
| E4 | 4500 K | V4 | 440 | XPLAWT-00-0000-000BV40E4 | XPLAWT-00-0000-000LV40E4 | |
| | | V3 | 420 | XPLAWT-00-0000-000BV30E4 | XPLAWT-00-0000-000LV30E4 | |
| | | V2 | 400 | XPLAWT-00-0000-000BV20E4 | XPLAWT-00-0000-000LV20E4 | |
| F5 | 4250 K | V4 | 440 | XPLAWT-00-0000-000BV40F5 | XPLAWT-00-0000-000LV40F5 | |
| | | V3 | 420 | XPLAWT-00-0000-000BV30F5 | XPLAWT-00-0000-000LV30F5 | |
| | | V2 | 400 | XPLAWT-00-0000-000BV20F5 | XPLAWT-00-0000-000LV20F5 | |
| E5 | 4000 K | V4 | 440 | XPLAWT-00-0000-000BV40E5 | XPLAWT-00-0000-000LV40E5 | |
| | | V3 | 420 | XPLAWT-00-0000-000BV30E5 | XPLAWT-00-0000-000LV30E5 | XPLAWT-00-0000-000HV30E5 |
| | | V2 | 400 | XPLAWT-00-0000-000BV20E5 | XPLAWT-00-0000-000LV20E5 | XPLAWT-00-0000-000HV20E5 |
| | | U6 | 380 | XPLAWT-00-0000-000BU60E5 | XPLAWT-00-0000-000LU60E5 | XPLAWT-00-0000-000HU60E5 |
| Z5 | 4000 K | V4 | 440 | XPLAWT-00-0000-000BV40Z5 | | |
| | | V3 | 420 | XPLAWT-00-0000-000BV30Z5 | XPLAWT-00-0000-000LV30Z5 | XPLAWT-00-0000-000HV30Z5 |
| | | V2 | 400 | XPLAWT-00-0000-000BV20Z5 | XPLAWT-00-0000-000LV20Z5 | XPLAWT-00-0000-000HV20Z5 |
| | | U6 | 380 | XPLAWT-00-0000-000BU60Z5 | XPLAWT-00-0000-000LU60Z5 | XPLAWT-00-0000-000HU60Z5 |
| F6 | 3700 K | V2 | 400 | | XPLAWT-00-0000-000LV20F6 | XPLAWT-00-0000-000LV20F6 |
| | | U6 | 380 | | XPLAWT-00-0000-000LU60F6 | XPLAWT-00-0000-000LU60F6 |
| | | U5 | 360 | | XPLAWT-00-0000-000LU50F6 | XPLAWT-00-0000-000LU50F6 |

* Cree XLamp XP Family LED order codes specify only a minimum flux bin and not a maximum. Cree may ship reels in flux bins higher than the minimum specified by the order code without advance notice. Shipments will always adhere to the chromaticity or DWL bin restrictions specified by the order code.

STANDARD ORDER CODES AND BINS (XP-L WARM WHITE, T_j = 85 °C)

| XLamp XP-L LED Standard Kit Codes - White | | | | | | | |
|---|--------|---------------------------------------|-----------|--------------------------|--------------------------|--------------------------|--------------------------|
| Chromaticity | | Minimum Luminous Flux (lm) @ 1050 mA* | | Order Codes | | | |
| Kit | CCT | Code | Flux (lm) | 80 CRI Typical | 80 CRI Minimum | 85 CRI Minimum | 90 CRI Minimum |
| ANSI Warm White (2700 K - 3500 K) | | | | | | | |
| E6 | 3500 K | V2 | 400 | XPLAWT-00-0000-000LV20E6 | XPLAWT-00-0000-000HV20E6 | | |
| | | U6 | 380 | XPLAWT-00-0000-000LU60E6 | XPLAWT-00-0000-000HU60E6 | | |
| | | U5 | 360 | XPLAWT-00-0000-000LU50E6 | XPLAWT-00-0000-000HU50E6 | | |
| Z6 | 3500 K | U6 | 380 | XPLAWT-00-0000-000LU60Z6 | XPLAWT-00-0000-000HU60Z6 | | |
| | | U5 | 360 | XPLAWT-00-0000-000LU50Z6 | XPLAWT-00-0000-000HU50Z6 | | |
| F7 | 3250 K | U6 | 380 | XPLAWT-00-0000-000LU60F7 | XPLAWT-00-0000-000HU60F7 | | |
| | | U5 | 360 | XPLAWT-00-0000-000LU50F7 | XPLAWT-00-0000-000HU50F7 | | |
| | | U4 | 340 | XPLAWT-00-0000-000LU40F7 | XPLAWT-00-0000-000HU40F7 | | |
| E7 | 3000 K | U6 | 380 | XPLAWT-00-0000-000LU60E7 | XPLAWT-00-0000-000HU60E7 | | |
| | | U5 | 360 | XPLAWT-00-0000-000LU50E7 | XPLAWT-00-0000-000HU50E7 | | |
| | | U4 | 340 | XPLAWT-00-0000-000LU40E7 | XPLAWT-00-0000-000HU40E7 | | |
| | | U3 | 320 | | | XPLAWT-00-0000-000PU30E7 | XPLAWT-00-0000-000UU30E7 |
| | | U2 | 300 | | | XPLAWT-00-0000-000PU20E7 | XPLAWT-00-0000-000UU20E7 |
| | | T6 | 280 | | | XPLAWT-00-0000-000PT60E7 | XPLAWT-00-0000-000UT60E7 |
| Z7 | 3000 K | U6 | 380 | XPLAWT-00-0000-000LU60Z7 | XPLAWT-00-0000-000HU60Z7 | | |
| | | U5 | 360 | XPLAWT-00-0000-000LU50Z7 | XPLAWT-00-0000-000HU50Z7 | | |
| | | U4 | 340 | XPLAWT-00-0000-000LU40Z7 | XPLAWT-00-0000-000HU40Z7 | | |
| | | U2 | 300 | | | XPLAWT-00-0000-000PU20Z7 | XPLAWT-00-0000-000UU20Z7 |
| | | T6 | 280 | | | XPLAWT-00-0000-000PT60Z7 | XPLAWT-00-0000-000UT60Z7 |
| F8 | 2850 K | U6 | 380 | XPLAWT-00-0000-000LU60F8 | XPLAWT-00-0000-000HU60F8 | | |
| | | U5 | 360 | XPLAWT-00-0000-000LU50F8 | XPLAWT-00-0000-000HU50F8 | | |
| | | U4 | 340 | XPLAWT-00-0000-000LU40F8 | XPLAWT-00-0000-000HU40F8 | | |
| | | U3 | 320 | | | XPLAWT-00-0000-000PU30F8 | XPLAWT-00-0000-000UU30F8 |
| | | U2 | 300 | | | XPLAWT-00-0000-000PU20F8 | XPLAWT-00-0000-000UU20F8 |
| | | T6 | 280 | | | XPLAWT-00-0000-000PT60F8 | XPLAWT-00-0000-000UT60F8 |
| | | T5 | 260 | | | XPLAWT-00-0000-000PT50F8 | XPLAWT-00-0000-000UT50F8 |
| E8 | 2700 K | U6 | 380 | XPLAWT-00-0000-000LU60E8 | | | |
| | | U5 | 360 | XPLAWT-00-0000-000LU50E8 | XPLAWT-00-0000-000HU50E8 | | |
| | | U4 | 340 | XPLAWT-00-0000-000LU40E8 | XPLAWT-00-0000-000HU40E8 | | |
| | | U3 | 320 | | | XPLAWT-00-0000-000PU30E8 | XPLAWT-00-0000-000UU30E8 |
| | | U2 | 300 | | | XPLAWT-00-0000-000PU20E8 | XPLAWT-00-0000-000UU20E8 |
| | | T6 | 280 | | | XPLAWT-00-0000-000PT60E8 | XPLAWT-00-0000-000UT60E8 |
| | | T5 | 260 | | | XPLAWT-00-0000-000PT50E8 | XPLAWT-00-0000-000UT50E8 |
| Z8 | 2700 K | U5 | 360 | XPLAWT-00-0000-000LU50Z8 | XPLAWT-00-0000-000HU50Z8 | | |
| | | U4 | 340 | XPLAWT-00-0000-000LU40Z8 | XPLAWT-00-0000-000HU40Z8 | | |
| | | U2 | 300 | | | XPLAWT-00-0000-000PU20Z8 | |
| | | T6 | 280 | | | XPLAWT-00-0000-000PT60Z8 | XPLAWT-00-0000-000UT60Z8 |
| | | T5 | 260 | | | XPLAWT-00-0000-000PT50Z8 | XPLAWT-00-0000-000UT50Z8 |

* Cree XLamp XP Family LED order codes specify only a minimum flux bin and not a maximum. Cree may ship reels in flux bins higher than the minimum specified by the order code without advance notice. Shipments will always adhere to the chromaticity or DWL bin restrictions specified by the order code.