

40

HERRAMIENTA INOX
INOX (STAINLESS STEEL) TOOLS
OUTILLAGE INOX
INOX WERKZEUGE
UTENSILI INOX
FERRAMENTA INOX
ИНСТРУМЕНТ ИЗ НЕРЖАВЕЮЩЕЙ СТАЛИ

INOX





INOX

Un mundo desarrollándose exponencialmente rápido, genera crecientes necesidades en materia de seguridad y aplicaciones de tecnología avanzada.

EGA Master ha desarrollado una nueva gama de herramientas de acero inoxidable para proporcionar soluciones a algunas de estas necesidades. El acero inoxidable 420* contribuye a evitar contaminaciones, oxidación y cumplimiento de requisitos de sala blanca.

A world developing exponentially fast, creates increasing needs on safety and technologically advanced applications.

EGA Master has developed a new range of stainless steel tools to provide solutions to some of these needs. 420 stainless steel contributes to avoid contaminations, rusting and complying with clean room environment requirements.*

Le monde en plein développement exponentiel, crée une augmentation des besoins en matière de sécurité et applications de technologie avancées

EGA Master a développé une nouvelle gamme d'outillages en acier inoxydable pour apporter des solutions à certains de ces besoins. L'acier inoxydable 420* contribue à éviter la contamination, l'oxydation en respectant les règles ambiantales des milieux extra sain.



* Los armarios portaherramientas inox están fabricados en acero inoxidable 430.
The stainless steel roller cabinets are made of 430 stainless steel.
 Les servantes en inox sont fabriquées en acier inoxydable 430.



Propiedades requeridas Property required Propriétés recommandées	Necesarias en Where needed Nécessité dans	Sectores Sectors Secteurs	Porque no acero al carbón Why not carbon steel Pourquoi pas d'acier au carbone	Porque acero inoxidable Why stainless steel Pourquoi acier inoxydable
<p>Tolerancia cero o baja a contaminación y partículas</p> <p><i>Zero or low tolerance to contamination and particles</i></p> <p>Tolérance base ou zéro à la contamination et aux particules</p>	<p>Producción esterilizada en entornos críticos</p> <p><i>Sterile production in critical environments</i></p> <p>Production stérilisée dans des milieux critiques</p>	Laboratorios / <i>Laboratories</i> / Laboratoires	<p>Sólo pueden ser esterilizadas unas pocas decenas de veces, ya que el cromado utilizado para evitar que se oxiden se deteriorará, se descascarillará con el tiempo, contaminando el proceso.</p> <p><i>They can only be sterilized few dozens of times, as the chrome plating used to avoid rust will deteriorate and chip off with time, contaminating the process</i></p> <p>Ne peuvent être stérilisés qu'une dizaine de fois vu que le chromé utilisé évitant l'oxydation se détériore et se déséquilibre avec le temps, contaminant le process</p>	<p>Los materiales y el acabado utilizados en su producción permiten su esterilización miles de veces.</p> <p><i>Materials and finishing used in their production enables sterilizing them thousands of times</i></p> <p>Les matériaux et la finition utilisés dans sa fabrication lui permette plus de 1000 stérilisation .</p>
		Biología y biomedicina <i>Biotech and biomedical</i> Biotechnologie et biomedical		
		Salas blancas / <i>Cleanrooms</i> / Chambres stériles		
		Farmacéuticas / <i>Pharmaceutical</i> / Pharmaceutique		
		Producción de nutrientes <i>Nutrient production</i> Production alimentaire		
		Industria nuclear <i>Nuclear industry</i> Industries nucléaires		
		Producción de obleas de silicio <i>Silicone wafer production</i> Production de plaquettes de silicium		
		Proceso de alimentos <i>Food processing</i> Process alimentaire		
Instalaciones en medios húmedos <i>Wet process facilities</i> Installation en milieu humides				
<p>Evitar la oxidación prematura de piezas por la contaminación de partículas</p> <p><i>Avoiding premature rust of parts by particle contamination</i></p> <p>Éviter l'échange d'oxydation de pièces par la contamination de particules</p>	<p>El uso de herramientas en componentes de acero inoxidable, tales como tornillos, tuercas, arandelas, tubos, barras, etc.</p> <p><i>Using tools on Stainless Steel components such as screws, nuts, washers, pipes, bars, etc.</i></p> <p>L'utilisation d'outils en acier inoxydables tout comme les vis, les écrous, rondelles, tubes, barres, ect.</p>	Sector naval / <i>Ship building</i> / Secteur naval	<p>Las herramientas de acero al carbono pueden dejar pequeñas partículas sobre los componentes de acero inoxidable, los cuales se pueden contaminar, y oxidarse</p> <p><i>Carbon steel tools can leave small particles on stainless steel components, which will get contaminated, and make them rust</i></p> <p>Les outils en acier de carbone peuvent laisser des petites particules sur les composants en acier inoxydables, qui peuvent être contaminés et oxidés</p>	<p>Las herramientas de acero inoxidable no contaminan otros componentes de acero INOX y, por lo tanto, no se produce su oxidación</p> <p><i>Stainless steel tools will not contaminate other SS components and thus not make them get rusted</i></p> <p>Les outils en aciers inoxydables ne contamineront les autres composants et par conséquent ne produiront aucune oxydation</p>
		Construcción / <i>Construction</i> / Construction		
		Fabricación / <i>Manufacturing</i> / Fabrication		
		Automóvil / <i>Automotive</i> / Automobile		
		Aeronáutica / <i>Aeronautics</i> / Aeronautique		
		Aplicaciones marítimas <i>Marine applications</i> Application maritimes		
		Estaciones de servicio y energía <i>Power</i> Station service et énergétique		
Industria química <i>Chemical Industries</i> Industries chimiques				
<p>Aumento de la vida útil de la herramienta</p> <p><i>Increasing tool lifetime</i></p> <p>Augmentation de la durée de vie utile des outils</p>	<p>Entornos corrosivos</p> <p><i>Corrosive environments</i></p> <p>Milieux corrosifs</p>	Naval (buques / mantenimiento de barcos) <i>Naval (vessels / ship maintenance)</i> Naval (navires / manutention de bateaux)	<p>Las herramientas de acero al carbono, incluso cuando están cromadas, se oxidarán rápidamente en áreas altamente corrosivas, dejándolas inutilizables y teniendo que reemplazarlas con frecuencia</p> <p><i>Carbon steel tools, even when they are chrome plated, will rust quickly in highly corrosive areas, leaving them unusable and having to replace them frequently</i></p> <p>Les outils en carbone, inclus quand ils sont en polies s'oxyderont de façon rapide dans des milieux hautement corrosifs et les laissant inutilisables et par conséquent seront remplacés plus fréquemment</p>	<p>El acero inoxidable es un acero de bajo contenido en carbono enriquecido con un 10 % de cromo, que permite la formación de una capa de óxido de cromo invisible que protege el núcleo de la oxidación. Incluso cuando la capa está dañada químicamente o mecánicamente, el oxígeno del medio ambiente reparará la capa de nuevo</p> <p><i>Stainless steel is a low carbon steel enriched with above 10% chromium, which allows the formation of an invisible chromium oxide layer that protects the core from rusting. Even when the layer is damaged chemically or mechanically, the oxygen of the environment will repair the layer again</i></p> <p>L'acier inoxydable est un acier à faible composition en carbone enrichi avec 10% de Chrome qui permet la formation d'une pellicule d'oxyde de Chrome invisible qui protège de l'oxydation. Même quand la pellicule est détériorée par un impact l'oxygène du milieu ambiant répare la pellicule</p>
		Subacuático / <i>Subaquatic</i> / Subaquatique		
		Offshore (Petróleo & Gas / Energía eólica...) <i>Offshore (Oil & Gas / Wind Power...)</i> Offshore (pétrole & gaz / énergie éolienne)		
		Plantas de energía nuclear <i>Nuclear Power plants</i> Plate-forme d'énergie nucléaire		
		Industria química <i>Chemical industries</i> Industries chimique		
		Entornos húmedos <i>Humid environments</i> Environnements humide		
		Proceso húmedo <i>Wet processing</i> Processus humide		
		Desalinización del agua <i>Water desalination</i> Évacuation des eaux		
		Explotación salinera <i>Salt production</i> Exploitation des salines		
		Plantas de tratamiento de aguas <i>Water treatment plants</i> Plate-forme du traitement des eaux		



Como ocurre con los aceros al carbono, hay docenas de diferentes aceros inoxidables y cada uno de ellos presenta diferentes propiedades para diferentes aplicaciones: algunos son más resistentes a la corrosión, otros son más resistentes a la tracción, otros más duros... Pero ninguno de ellos mejor en todo el conjunto de propiedades.

EGA Master ha elegido el acero inoxidable 420 para la fabricación de sus herramientas, ya que combina de manera óptima las diferentes propiedades requeridas para la fabricación y uso de herramientas de acero inoxidable:

As with carbon steels, there are dozens of different stainless steels, each of them presenting different properties for different applications. Some are more resistant to rust, some other are stronger, some harder... But non of them is best in all properties.

EGA Master has chosen 420 Stainless steel for the manufacturing its tools, as it combines optimally different properties required for manufacturing and use of stainless steel tools:

Comme avec les aciers au carbone, il existe une douzaine de différents aciers inoxidables, qui chacun d'entre eux présente différentes propriétés pour différentes applications. Certains sont plus résistants à la corrosion, d'autres plus résistants à la traction, d'autres plus dur... Mais aucun meilleur dans un ensemble de propriétés.

EGA Master a élu l'acier inoxydable 420 pour la fabrication de ses outils, vu qu'il associe de façon optimale les différentes propriétés requise pour la fabrication et l'utilisation d'outils en acier inoxydable:

Dureza / Hardness / Dureté	38-48 HRC
Resistencia a la tracción / Tensile Strength / Resistance à la traction	≥ 635 N/mm ²

Propiedades / Properties / Propriétés	Aplicación y beneficios / Application & benefits / Application et bénéfices
Evita la contaminación / Avoiding contamination / Evite la contamination	No contaminación por hierro o cromo-níquel / No iron or chrome-nickel contamination / Pas de contamination de l'acier et Chrome-nikel
Esterilización / Sterilization / Stérilisation	Miles de procesos de esterilización / Thousands of sterilizing processes / 1000 process de stérilisation
Vida útil / Durability / Longévité	La dureza, resistencia y protección antioxido proporcionan mayor durabilidad / Combination of hardness, resistance and antirust protection makes it most durable / La dureté, resistance et protection antioxidante proportionne une plus grande longévité
Coste / Cost / Coût	Siendo una aleación para su producción en serie, junto con sus buenas propiedades de fabricación hace que sea más rentable para la fabricación de herramientas / Being a mass production alloy together with having good manufacturing properties makes it most cost effective for tool manufacturing / En aléation à une fabrication en serie, et en conjunction avec ses excellentes propriétés de fabrication fait qu'il est plus rentable

MAT: 420		
Composición / Composition / Composition	C	0,16 - 0,25 %
	Mn	≤ 1,00 %
	Si	≤ 1,00 %
	Cr	12 % - 14 %

En EGA Master estamos seguros de que la prevención es la cura más eficaz no sólo para aumentar la seguridad, sino también desde el punto de vista de la reducción de costes. Eliminar el riesgo de transferencia ferrosa es un factor clave para aumentar la rentabilidad a largo plazo, mientras se mantienen la seguridad en procesos y personas.

In EGA Master we are sure that prevention is the most effective cure not only for increased safety, but also from an cost effective point of view. Eliminating the risk of ferrous transfer is a key factor for increasing profitability on the long term, while keeping processes, and people, safe.

Chez EGA Master nous sommes sûr que la prévention est le remède le plus efficace pour augmenter la sécurité, mais aussi d'un point de vue de réduction de coût. Eliminer le risque de transfert ferreux est un facteur clef pour augmenter la rentabilité a long terme, tout en maintenant la sécurité du process et des personnes.

PRECAUCIONES
CAUTION
PRÉCAUTIONS

Estas herramientas no están clasificadas como antimagnéticas, sino que se trata de herramientas fabricadas en acero inoxidable martensítico-ferromagnético cuya permeabilidad magnética es muy superior a la unidad.

These tools are not classified as non-magnetic but tools made of martensitic - ferromagnetic stainless steel whose magnetic permeability is much higher than the unit.

Cet outillage n'est pas classé comme antimagnétique, il s'agit d'un outillage fait en acier inoxydable martensitique-ferromagnétique dont la perméabilité magnétique est très supérieure à l'unité.

■ **ALICATES / PLIERS / PINCES / ZANGEN / PINZE / ALICATES / ПЛОСКОГУБЦЫ**

■ **UNIVERSALES / COMBINATION / UNIVERSELLES / KOMBIZANGEN / UNIVERSALI / UNIVERSAIS / КОМБИНИРОВАННЫЕ**

COD.	L (mm)	g
38000	160	230
38001	180	280
38002	200	360



■ **BOCA PLANA / FLAT NOSE / BEC PLATS / FLACHZANGEN / BECCHI PIATTI / PONTAS CHATAS / УТКОНОСЫ**

COD.	L (mm)	g
38003	160	170



■ **BOCA REDONDA / ROUND NOSE / BECS RONDS / RUNDZANGEN / BECCHI TONDI / PONTAS REDONDAS / КРУГЛОГУБЦЫ**

COD.	L (mm)	g
38004	160	150



■ **TELEFONISTA / LONG NOSE / TÉLÉPHONE / TELEFONZANGEN / TELEFONISTI / TELEFONISTA / СУДЛИННЕННЫМИ НОСАМИ**

COD.	L (mm)	g
38005	160	170
38006	200	230



■ **TELEFONISTA BOCA CURVA / BENT NOSE PLIERS / TÉLÉPHONE BECS COUDÉS / TELEFONZANGEN GEBOGEN / TELEFONISTI BECCHI PIEGATI / TELEFONISTA PONTAS CURVAS / ИЗОГНУТЫМИ НОСАМИ**

COD.	L (mm)	g
38007	160	160
38008	200	230



■ **BOCA AGUJA / LONG NEEDLE NOSE / LONG BECS DEMI-RONDS / FLACHZANGE MIT LANGEM MAUL / BECCHI TONDI AFFUSOLATI / PONTAS AGULHA / УДЛИНЕННЫЕ ТОНКИЕ**

COD.	L (mm)	g
38086	160	110



■ **CORTE DIAGONAL / DIAGONAL CUTTING PLIERS / COUPANTES DIAGONALES / SEITENSCHNEIDER / TAGLIO LATERALE / CORTE DIAGONAL / УДЛИНЕННЫЕ ТОНКИЕ**

COD.	L (mm)	g
38009	160	200
38010	190	230



■ **CORTE DIAGONAL REFORZADO / HEAVY DUTY CUTTING NIPPERS / COUPANTES RENFORCÉS / VERSTÄRKTER SEITENSCHNEIDER / TAGLIO LATERALE RINFORZATO / CORTE DIAGONAL REFORÇADO / УСИЛЕННЫЕ БОКОРЕЗЫ**

COD.	L (mm)	g
38011	180	270
38012	200	340



■ **CORTE FRONTAL / END CUTTING NIPPER / COUPANTES DEVANT / VORSCHNEIDER / TAGLIO FRONTALE / CORTE FRONTAL / КЛЕЩИ**

COD.	L (mm)	g
38013	160	250



CORTE FRONTAL ELECTRICISTA / END CUTTING NIPPER (ELECTRICIAN) / COUPANTES DEVANT ELECTRICIEN / ELEKTRIKER VORSCHNEIDER / TAGLIO FRONTALE PER ELETTRICISTI / CORTE FRONTAL ELECTRICISTA / КЛЕЩИ (ЭЛЕКТРИЧЕСКИЕ)

COD.	L (mm)	g
38014	160	250
38015	200	340



RELACABLES / WIRESTRIPPER / PINCES À DÉNUDER / ABISOLIERZANGEN / PINZE SPELAFILI / DECAPADORES / КЛЕЩИ ДЛЯ ЗАЧИСТКИ КОНТАКТОВ

COD.	L (mm)	g
38016	160	200



ALICATES MINIS / MINI PLIERS / PINCES MINI / MINI ZANGEN / PINZE MINI / ALICATES MINI / ПЛОСКОГУБЦЫ МИНИ

UNIVERSALES / COMBINATION / UNIVERSELLES / KOMBIZANGEN / UNIVERSALI / UNIVERSAIS / КОМБИНИРОВАННЫЕ

COD.	L (mm)	g
38081	125	90



BOCA PLANA / FLAT NOSE / BECS PLATS / FLACHZANGEN / BECCHI PIATTI / PONTAS CHATAS / УТКОНОСЫ

COD.	L (mm)	g
38082	130	70



BOCA REDONDA / ROUND NOSE / BECS RONDS / RUNDZANGEN / BECCHI TONDI / PONTAS REDONDAS / КРУГЛОГУБЦЫ

COD.	L (mm)	g
38083	130	80



TELEFONISTA / LONG NOSE / TÉLÉPHONE / TELEFONZANGEN / TELEFONISTI / TELEFONISTA / СУДЛИННЕННЫМИ НОСАМИ

COD.	L (mm)	g
38084	130	70



TELEFONISTA BOCA CURVA / BENT NOSE PLIERS / TÉLÉPHONE BECS COUDÉS / TELEFONZANGEN GEBOGEN / TELEFONISTI BECCHI PIEGATI / TELEFONISTA PONTAS CURVAS / C ИЗОГНУТЫМИ НОСАМИ

COD.	L (mm)	g
38085	130	80



CORTE DIAGONAL / DIAGONAL CUTTING PLIERS / COUPANTES DIAGONALES / SEITENSCHNEIDER / TAGLIO LATERALE / CORTE DIAGONAL / УДЛИНЕННЫЕ ТОНКИЕ

COD.	L (mm)	g
38087	115	70



CORTE DIAGONAL TRIANGULAR / DIAGONAL CUTTING TRIANGULAR / COUPANTES DIAGONALE TRIANGULAIRE / SEITENSCHNEIDER / TAGLIO LATERALE TRIANGOLARE / CORTE DIAGONAL TRIANGULAR / БОКОРЕЗЫ ТРЕУГОЛЬНЫЕ

COD.	L (mm)	g
38088	115	80



CORTE FRONTAL / END CUTTING NIPPER / COUPANTES DEVANT / VORSCHNEIDER / TAGLIO FRONTALE / CORTE FRONTAL / КЛЕЩИ

COD.	L (mm)	g
38089	110	65



TENAZAS / PINCERS / PINCES / ZANGE / TENAGLIE / ALICATES / КЛЕЩИ

DE CANAL / BOX JOINT / MULTIPRISE ENTREPASSÉE / WASSERPUMPENZANGE / PINZE REGOLABILI / BICO DE PAPAGAIO / ШАРНИРНЫЕ

COD.	L (inch)	g
38066	10	320
38067	12	515



PICO DE LORO / GROOVE JOINT / MULTIPRISE À CRÉMAILLÈRE / WASSERPUMPENZANGE / PINZE REGOLABILI / BICO DE PAPAGAIO / КЛЕЩИ ЖЕЛОБКОВОГО ТИПА

COD.	L (inch)	g
38176	10	360
38177	12	610



■ **LLAVES / WRENCHES / CLÉS / SCHLÜSSEL / CHIAVI / CHAVES / КЛЮЧИ**

■ **LLAVE AJUSTABLE / ADJUSTABLE WRENCH / CLÉ À MOLETTE / ROLLGABELSCHÜSSEL / CHIAVE REGOLABILI A RULLINO / CHAVE AJUSTAVEL / РАЗВОДНЫЕ КЛЮЧИ**

COD.	L (inch)	L (mm)	AF mm	g
38171	8	200	24	240
38172	10	250	28	445
38173	12	300	34	680



■ **LLAVES COMBINADAS / COMBINATION WRENCHES / CLÉS MIXTES / GABEL RINGSCHLÜSSEL / CHIAVI COMBINATE / CHAVES BOCA E LUNETA / КОМБИНИРОВАННЫЕ КЛЮЧИ**

■ **MM**

COD.	L (mm)	AF mm	g
38090		6	10
38091	115	7	20
38092		8	
38093		9	
38094	140	10	30
38095		11	40
38096	160	12	50
38097		13	60
38098	180	14	70
38099		15	80
38100	200	16	90
38101		17	110
38102		18	120
38103	225	19	140
38104		20	170
38105	250	21	180
38106		22	200
38107		23	220
38108	270	24	260
38109		25	300
38110	290	26	310
38111		27	340
38112		28	380
38113	320	29	390
38114		30	430
38115	350	32	550

■ **INCH**

COD.	L (mm)	AF inch	g
38116	115	1/4	17
38117		5/16	
38118		11/32	
38119	140	3/8	38
38121		13/32	
38120	160	7/16	
38122		1/2	48
38123	180	9/16	70
38124		5/8	
38125	200	11/16	120
38126	225	3/4	150
38127		13/16	
38128	250	25/32	210
38129		7/8	
38130	270	15/16	
38131		31/32	260
38132	290	1	
38133		1.1/16	320
38134		1.1/8	
38135	320	1.3/16	400
38136	350	1.1/4	525
38168	360	1.3/8	710
38169	380	1.1/2	990

■ **LLAVES HEXAGONALES / HEXAGONAL KEYS / CLÉS MÂLES / INBUSSCHLÜSSEL / CHIAVI ESAGONALI / CHAVES HEXAGONAIS / ШЕСТИГРАННЫЕ КЛЮЧИ**

■ **STANDARD**

■ **MM**

COD.	L (mm)	AF mm	H (mm)	g
38036	55	2,5	18	5
38037		3		
38038	65	3,5	20	10
38039		4	25	
38040	85	5	26	20
38041		6	32	30
38042	95	7	34	40
38043		8	36	60
38044	105	9	38	80
38045		10	40	110
38046	120	11	42	150
38047		12	45	170





■ **SERIE LARGA / LONG PATTERN / SÉRIE LONGUE / LANGE SERIE / SERIE LUNGA / SERIE LONGA / ДЛИННЫЙ**

■ **MM**





COD.	L (mm)	AF mm	H (mm)	g
38048	105	2,5	18	10
38049		3	20	
38050	120	4	25	20
38051		5	28	30
38052	145	6	32	50
38053		7	34	70
38054	160	8	36	100
38055		9	38	150
38056	180	10	40	180
38057		11	42	250
38058	200	12	45	290

■ **DESTORNILLADORES / SCREWDRIVERS / TOURNEVIS / SCHRAUBENDREHER / CACCIAVITI / CHAVES DE FENDA / ОТВЕРТКИ**

■ **ELECTRICISTA / ELECTRICIAN / ELECTRICIEN / ELEKTRIKER / PER ELETRICISTI / ELECTRICISTA / ЭЛЕКТРИЧЕСКАЯ**





COD.				
	mm	mm	mm	g
38150	80	3	75	40
38151		4		60
38152	100	5	90	90
38153		6		130
38154	150	8		170
38155		10		200
38156	200	12	120	260
38157		14		320







COD.				
	mm	mm	mm	g
38017	80	3	75	40
38018		4		60
38019	100	5	90	90
38020		6		130
38021	150	8		170
38022		10		200
38023	300		120	220
38024	200	12		260
38025		14		320



■ **PHILIPS**





COD.				
	mm		mm	g
38158	60	PH0	75	30
38159	80	PH1	90	80
38160	100	PH2	110	120
38161	150	PH3		190
38162	200	PH4	120	270







COD.				
	mm		mm	g
38026	60	PH0	75	30
38027	80	PH1	90	80
38028	100	PH2	110	120
38029	150	PH3	120	190
38030	200	PH4	75	270



■ **POZIDRIV®***

COD.				
	mm		mm	g
38163	60	PZ0	75	40
38164	80	PZ1	90	80
38165	100	PZ2	110	120
38166	150	PZ3		190
38167	200	PZ4	120	270



COD.				
	mm		mm	g
38031	60	PZ0	75	40
38032	80	PZ1	90	80
38033	100	PZ2	110	120
38034	150	PZ3		190
38035	200	PZ4	120	270



*Para tornillos POZIDRIV® (Marca registrada por European Ind. Serv. Ltd.) / *For screws POZIDRIV® (European Ind. Serv. Ltd. registered trademark) / *Pour vis POZIDRIV® (Marque enregistrée par European Ind. Serv. Ltd.)

■ **CUÑA / WEDGE / COIN / KEIL / CUNEO / CUNHA / КЛИН**

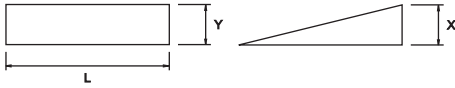

COD.	L (mm)	Y	X	Kg
38059	80	13	6	0,02
38060	100		10	0,20
38061	150	50	13	0,38
38062	180		19	0,67
38063	200		12	0,47
38064	250	40	30	1,17
38065	300	50	40	2,34



■ **MARTILLOS / HAMMERS / MARTEAUX / HÄMMER / MARTELLI / MARTELOS / МОЛОТКИ**

■ **MARTILLO DE BOLA / BALL PEIN HAMMER / MARTEAU À BOULE / SCHLOSSER HAMMER / MARTELLO A PALLA / MARTELO DE BOLA / МОЛОТОК С ШАРОВОЙ ГОЛОВКОЙ**

COD.	L (mm)	g
38068	350	725



■ **MACETA OCTOGONAL / SLEDGE HAMMER / MASSETTE OCTOGONALE / SCHLAGHAMMER / MAZZETTA OTTOGONALE / MARRETA OCTOGONAL / КУВАЛДА**

COD.	L (mm)	Kg
38069		1
38070	350	1,5
38071		2
38072		2,5
38073	850	3
38074		3,5



■ **MACETA CUADRADA TIPO ALEMÁN / GERMAN TYPE STONING HAMMER / MASSETTE TYPE ALLEMAND / FÄUSTEL / MAZZETA / MARRETA / КУВАЛДА НЕМЕЦКИЙ ТИП ДЛЯ КАМНЯ**

COD.	L (mm)	Kg
38179		1
38180		1,5
38181	400	2
38182		2,5
38183		3
38184	900	3,5



■ **MARTILLO DE EBANISTA / JOINER'S HAMMER / MARTEAU DE MENUISIER / HOLZSCHNITZERHAMMER / MARTELLO FALEGNAME / MARTELO DE PENA / СТОЛЯРНЫЙ МОЛОТОК**

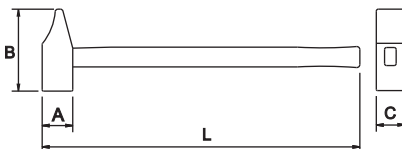

COD.	L (mm)	A (mm)	g
38075		18	230
38076	280	20	290
38077		22	350
38078	300	25	500
38079		28	600
38080	350	30	780



40

HERRAMIENTA INOX
INOX (STAINLESS STEEL) TOOLS
OUTILLAGE INOX
INOX WERKZEUGE
UTENSILI INOX
FERRAMENTA INOX
ИНСТРУМЕНТ ИЗ НЕРЖАВЕЮЩЕЙ СТАЛИ



ARMARIOS-CARROS DE HERRAMIENTAS TOTALMENTE DE ACERO INOXIDABLE / ROLLER CABINETS ENTIRELY IN STAINLESS STEEL / SERVANTES À ROUES TOTALEMENT EN ACIER INOXYDABLE / WERKZEUGWAGEN AUS EDELSTAHL / CASSETTIERE MOBILI TOTALMENTE IN ACCIAIO INOX / CARRO DE FERRAMENTAS TOTALMENTE EM AÇO INOXIDÁVEL / ИНСТРУМЕНТАЛЬНАЯ ТЕЛЕЖКА С ВЫДВИЖНЫМИ ЯЩИКАМИ ИЗ Н/Ж СТАЛИ



Sistema antivuelco con botón de seguridad de apertura individual por bandeja
 Anti-overnut system with individual safety open button in each tray
 Système anti-renversement avec bouton de sécurité d'ouverture individuelle par tiroir

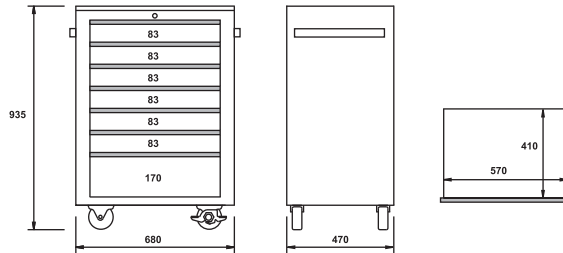

INOX

COD.	L x W x H (mm)	Material estructura / Material structure / Structure matériaux	Kg
51558	680 x 470 x 935	Inox 304	63

ESPECIFICACIONES TÉCNICAS / TECHNICAL SPECIFICATION / DÉTAILS TECHNIQUES

Material / Material / Matière	INOX / INOX / INOX
5 cajones con rodamientos / 5 ball-bearing slides / 5 tiroirs à roulement	7
2 ruedas fijas y 2 giratorias con freno / 2 fixed and 2 revolving with brake wheels / 2 roues fixes et 2 roues giratoires avec frein	5" x 1,5"
Capacidad cajones de altura 83 mm / Capacity in 83 mm height drawers / Capacité des tiroirs de 83 mm de haut	25 Kg
Capacidad cajones de altura 170 mm / Capacity in 170 mm height drawers / Capacité des tiroirs de 170 mm de haut	30 Kg
Capacidad de carga estática total / Total static weight capacity / Capacité totale de charge statique	320 Kg
Sistema de cierre centralizado / Central locking system / Système de fermeture centralisée	●
Asa lateral reforzada / Reinforced side handle / Poignées latérale renforcée	●
Sistema antivuelco en cada bandeja / Anti-overnut system in each drawers / Système anti-renversement dans chaque tiroir	●



Sistema antivuelco con botón de seguridad de apertura individual por bandeja
 Anti-overnut system with individual safety open button in each tray
 Système anti-renversement avec bouton de sécurité d'ouverture individuelle par tiroir

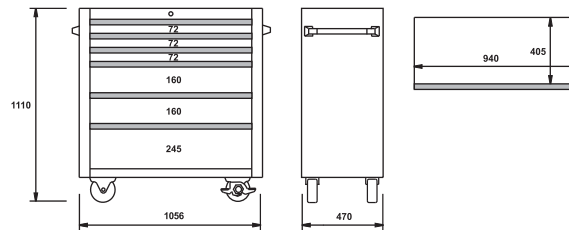

INOX

COD.	L x W x H (mm)	Material estructura / Material structure / Structure matériaux	Kg
51559	1056 x 470 x 1110	Inox 304	95

ESPECIFICACIONES TÉCNICAS / TECHNICAL SPECIFICATION / DÉTAILS TECHNIQUES

Material / Material / Matière	INOX / INOX / INOX
5 cajones con rodamientos / 5 ball-bearing slides / 5 tiroirs à roulement	6
2 ruedas fijas y 2 giratorias con freno / 2 fixed and 2 revolving with brake wheels / 2 roues fixes et 2 roues giratoires avec frein	5" x 1,5"
Capacidad cajones de altura 83 mm / Capacity in 83 mm height drawers / Capacité des tiroirs de 83 mm de haut	25 Kg
Capacidad cajones de altura 170 mm / Capacity in 170 mm height drawers / Capacité des tiroirs de 170 mm de haut	30 Kg
Capacidad cajones de altura 257 mm / Capacity in 257 mm height drawers / Capacité des tiroirs de 257 mm de haut	30 kg
Capacidad de carga estática total / Total static weight capacity / Capacité totale de charge statique	500 kg
Sistema de cierre centralizado / Central locking system / Système de fermeture centralisée	●
Asa lateral reforzada / Reinforced side handle / Poignées latérale renforcée	●
Sistema antivuelco en cada bandeja / Anti-overnut system in each drawers / Système anti-renversement dans chaque tiroir	●

Si no encuentra el artículo que necesita, consúltenos en info@egamaster.com o en www.egamaster.com
 If you can't find the item you look for, please ask us in info@egamaster.com or in www.egamaster.com
 Si vous ne trouvez pas l'article que vous desirez, consultez-nous à info@egamaster.com ou à www.egamaster.com

EGA Master
 ART IN INNOVATION

1123

ARMARIOS-CARROS DE HERRAMIENTAS EN ACERO INOXIDABLE / STAINLESS STEEL ROLLER CABINETS / SERVANTES À ROUES EN ACIER INOXYDABLE / EDELSTAHL WERKZEUGWAGEN / CASSETTIERE MOBILI IN ACCIAIO INOX / CARRO DE FERRAMENTAS COM GAVETAS EM AÇO INOX / ТЕЛЕЖКА ИНСТРУМЕНТАЛЬНАЯ ИЗ НЕРЖАВЕЮЩЕЙ СТАЛИ НА РОЛИКАХ



Sistema antivuelco con botón de seguridad de apertura individual por bandeja
 Anti-overturn system with individual safety open button in each tray
 Système anti-renversement avec bouton de sécurité d'ouverture individuelle par tiroir

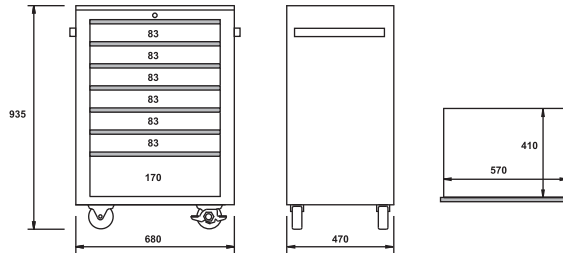

INOX

COD.	L x W x H (mm)	Material estructura / Material structure / Structure matériaux	Material ruedas / Wheel material / Matière roues	Kg
51478	680 x 470 x 935	Inox 430	Inox 304	63

ESPECIFICACIONES TÉCNICAS / TECHNICAL SPECIFICATION / DÉTAILS TECHNIQUES

5 cajones con rodamientos / 5 ball-bearing slides / 5 tiroirs à roulement	7
2 ruedas fijas y 2 giratorias con freno / 2 fixed and 2 revolving with brake wheels / 2 roues fixes et 2 roues giratoires avec frein	5" x 1,5"
Capacidad cajones de altura 83 mm / Capacity in 83 mm height drawers / Capacité des tiroirs de 83 mm de haut	25 Kg
Capacidad cajones de altura 170 mm / Capacity in 170 mm height drawers / Capacité des tiroirs de 170 mm de haut	30 Kg
Capacidad de carga estática total / Total static weight capacity / Capacité totale de charge statique	320 Kg
Sistema de cierre centralizado / Central locking system / Système de fermeture centralisée	●
Asa lateral reforzada / Reinforced side handle / Poignées latérale renforcée	●
Sistema antivuelco en cada bandeja / Anti-overturn system in each drawers / Système anti-renversement dans chaque tiroir	●



Sistema antivuelco con botón de seguridad de apertura individual por bandeja
 Anti-overturn system with individual safety open button in each tray
 Système anti-renversement avec bouton de sécurité d'ouverture individuelle par tiroir

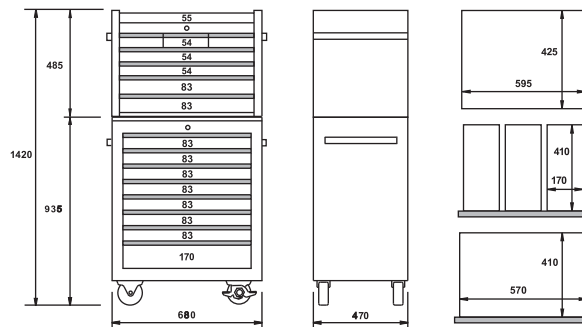

INOX

COD.	L x W x H (mm)	Kg	Material estructura / Material structure / Structure matériaux	Material ruedas / Wheel material / Matière roues
51563	680 x 470 x 1420	109	Inox 430	Inox 304

ESPECIFICACIONES TÉCNICAS / TECHNICAL SPECIFICATION / DÉTAILS TECHNIQUES

5 cajones con rodamientos / 5 ball-bearing slides / 5 tiroirs à roulement	14
Tapa con doble pistón neumático / Double pneumatic absorber equipped lid / Couvercle avec double piston pneumatique	●
2 ruedas fijas y 2 giratorias con freno / 2 fixed and 2 revolving with brake wheels / 2 roues fixes et 2 roues giratoires avec frein	5" x 1,5"
Capacidad cajones 170,5 x 410 x 54 mm / Capacity in 170,5 x 410 x 54mm drawers / Capacité des tiroirs de 170,5 x 410 x 54 mm	15 kg
Capacidad cajones 570 x 410 x 54 mm / Capacity in 570 x 410 x 54 mm drawers / Capacité des tiroirs de 570 x 410 x 54 mm	25 kg
Capacidad cajones de altura 83 mm / Capacity in 83 mm height drawers / Capacité des tiroirs de 83 mm de haut	25 Kg
Capacidad cajones de altura 170 mm / Capacity in 170 mm height drawers / Capacité des tiroirs de 170 mm de haut	30 Kg
Capacidad de carga estática total / Total static weight capacity / Capacité totale de charge statique	470 kg
Sistema de cierre centralizado / Central locking system / Système de fermeture centralisée	●
Asa lateral reforzada / Reinforced side handle / Poignées latérale renforcée	●
Sistema antivuelco en cada bandeja / Anti-overturn system in each drawers / Système anti-renversement dans chaque tiroir	●

40

HERRAMIENTA INOX
INOX (STAINLESS STEEL) TOOLS
OUTILLAGE INOX
INOX WERKZEUGE
UTENSILI INOX
FERRAMENTA INOX
ИНСТРУМЕНТ ИЗ НЕРЖАВЕЮЩЕЙ СТАЛИ

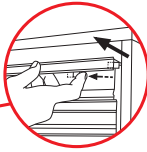

Sistema antivuelco con botón de seguridad de apertura individual por bandeja
Anti-overtum system with individual safety open button in each tray
 Système anti-renversement avec bouton de sécurité d'ouverture individuelle par tiroir

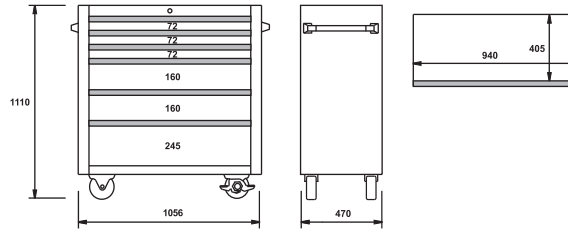

INOX

COD.	L x W x H (mm)	Material estructura / Material structure / Structure matériaux	Material ruedas / Wheel material / Matière roues	Kg
51561	1056 x 470 x 1110	Inox 430	Inox 304	95

ESPECIFICACIONES TÉCNICAS / TECHNICAL SPECIFICATION / DÉTAILS TECHNIQUES

5 cajones con rodamientos / 5 ball-bearing slides / 5 tiroirs à roulement	6
2 ruedas fijas y 2 giratorias con freno / 2 fixed and 2 revolving with brake wheels / 2 roues fixes et 2 roues giratoires avec frein	5" x 1,5"
Capacidad cajones de altura 83 mm / Capacity in 83 mm height drawers / Capacité des tiroirs de 83 mm de haut	25 Kg
Capacidad cajones de altura 170 mm / Capacity in 170 mm height drawers / Capacité des tiroirs de 170 mm de haut	30 Kg
Capacidad cajones de altura 257 mm / Capacity in 257 mm height drawers / Capacité des tiroirs de 257 mm de haut	30 kg
Capacidad de carga estática total / Total static weight capacity / Capacité totale de charge statique	500 kg
Sistema de cierre centralizado / Central locking system / Système de fermeture centralisée	●
Asa lateral reforzada / Reinforced side handle / Poignées latérale renforcée	●
Sistema antivuelco en cada bandeja / Anti-overtum system in each drawers / Système anti-renversement dans chaque tiroir	●

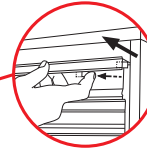

Sistema antivuelco con botón de seguridad de apertura individual por bandeja
Anti-overtum system with individual safety open button in each tray
 Système anti-renversement avec bouton de sécurité d'ouverture individuelle par tiroir

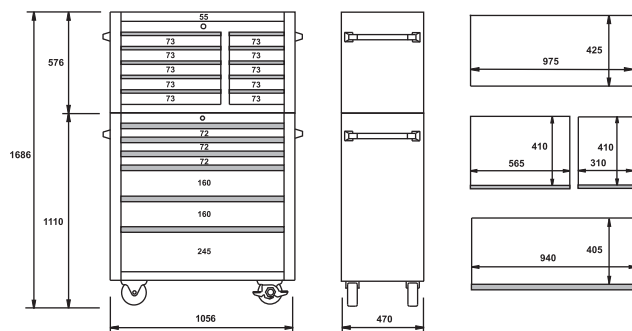

INOX

COD.	L x W x H (mm)	Kg	Material estructura / Material structure / Structure matériaux	Material ruedas / Wheel material / Matière roues
51564	1056 x 470 x 1686	168	Inox 430	Inox 304

ESPECIFICACIONES TÉCNICAS / TECHNICAL SPECIFICATION / DÉTAILS TECHNIQUES

5 cajones con rodamientos / 5 ball-bearing slides / 5 tiroirs à roulement	16
2 ruedas fijas y 2 giratorias con freno / 2 fixed and 2 revolving with brake wheels / 2 roues fixes et 2 roues giratoires avec frein	5" x 1,5"
Capacidad cajones de altura 83 mm / Capacity in 83 mm height drawers / Capacité des tiroirs de 83 mm de haut	25 Kg
Capacidad cajones de altura 170 mm / Capacity in 170 mm height drawers / Capacité des tiroirs de 170 mm de haut	30 Kg
Capacidad cajones de altura 257 mm / Capacity in 257 mm height drawers / Capacité des tiroirs de 257 mm de haut	30 kg
Capacidad de carga estática total / Total static weight capacity / Capacité totale de charge statique	700 kg
Sistema de cierre centralizado / Central locking system / Système de fermeture centralisée	●
Asa lateral reforzada / Reinforced side handle / Poignées latérale renforcée	●
Sistema antivuelco en cada bandeja / Anti-overtum system in each drawers / Système anti-renversement dans chaque tiroir	●

Si no encuentra el artículo que necesita, consúltenos en info@egamaster.com o en www.egamaster.com
 If you can't find the item you look for, please ask us in info@egamaster.com or in www.egamaster.com
 Si vous ne trouvez pas l'article que vous desirez, consultez-nous à info@egamaster.com ou à www.egamaster.com

COFRE PORTAHERRAMIENTAS EN ACERO INOXIDABLE / STAINLESS STEEL TOOL CHEST / COFFRE À TIROIRS EN ACIER INOXYDABLE / EDELSTAHL WERKSTATTKASTEN / CASSETTA PORTAUTENSILI IN ACCIAIO INOX / BAÚ PARA FERRAMENTAS EM AÇO INOX / ИНСТРУМЕНТАЛЬНЫЙ ЯЩИК ИЗ Н/Ж СТАЛИ

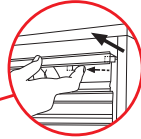

Sistema antivuelco con botón de seguridad de apertura individual por bandeja
 Anti-overturn system with individual safety open button in each tray
 Système anti-renversement avec bouton de sécurité d'ouverture individuelle par tiroir

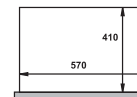
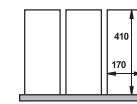
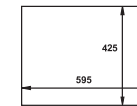
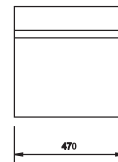
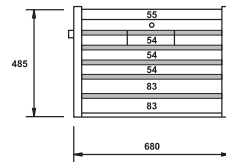

INOX

N!

COD.	L x W x H (mm)	Material estructura / Material structure / Structure matériaux	Kg
51560	680 x 470 x 485	Inox 430	45,5

ESPECIFICACIONES TÉCNICAS / TECHNICAL SPECIFICATION / DÉTAILS TECHNIQUES

5 cajones con rodamientos / 5 ball-bearing slides / 5 tiroirs à roulement	7
Tapa con doble pistón neumático / Double pneumatic absorber equipped lid / Couvercle avec double piston pneumatique	●
Capacidad cajones 170,5 x 410 x 54 mm / Capacity in 170,5 x 410 x 54mm drawers / Capacité des tiroirs de 170,5 x 410 x 54 mm	15 kg
Capacidad cajones 570 x 410 x 54 mm / Capacity in 570 x 410 x 54 mm drawers / Capacité des tiroirs de 570 x 410 x 54 mm	25 kg
Capacidad cajones de altura 83 mm / Capacity in 83 mm height drawers / Capacité des tiroirs de 83 mm de haut	25 kg
Capacidad de carga estática total / Total static weight capacity / Capacité totale de charge statique	150 kg
Sistema de cierre centralizado / Central locking system / Système de fermeture centralisée	●
Asa lateral reforzada / Reinforced side handle / Poignées latérale renforcée	●
Sistema antivuelco en cada bandeja / Anti-overturn system in each drawers / Système anti-renversement dans chaque tiroir	●

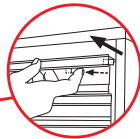

Sistema antivuelco con botón de seguridad de apertura individual por bandeja
 Anti-overturn system with individual safety open button in each tray
 Système anti-renversement avec bouton de sécurité d'ouverture individuelle par tiroir

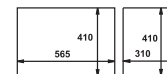
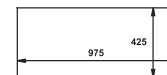
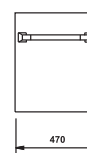
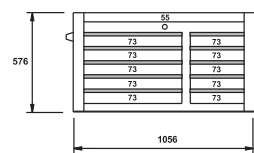

INOX

N!

COD.	L x W x H (mm)	Material estructura / Material structure / Structure matériaux	Kg
51562	1056 x 470 x 576	Inox 430	95

ESPECIFICACIONES TÉCNICAS / TECHNICAL SPECIFICATION / DÉTAILS TECHNIQUES

5 cajones con rodamientos / 5 ball-bearing slides / 5 tiroirs à roulement	10
Capacidad cajones de altura 83 mm / Capacity in 83 mm height drawers / Capacité des tiroirs de 83 mm de haut	25 kg
Capacidad de carga estática total / Total static weight capacity / Capacité totale de charge statique	200 kg
Sistema de cierre centralizado / Central locking system / Système de fermeture centralisée	●
Asa lateral reforzada / Reinforced side handle / Poignées latérale renforcée	●
Sistema antivuelco en cada bandeja / Anti-overturn system in each drawers / Système anti-renversement dans chaque tiroir	●