

HL64F/1

7,8 l/s
DN110

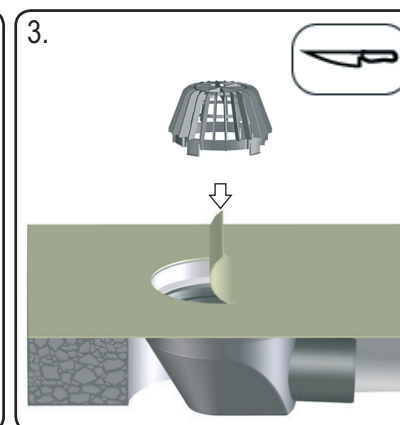
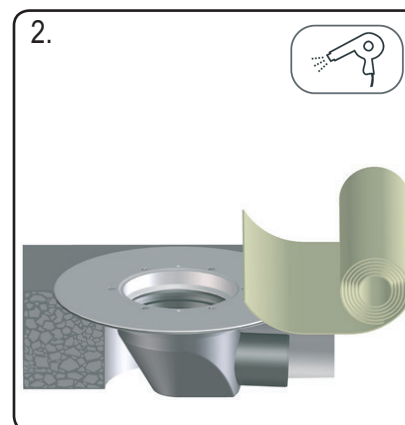
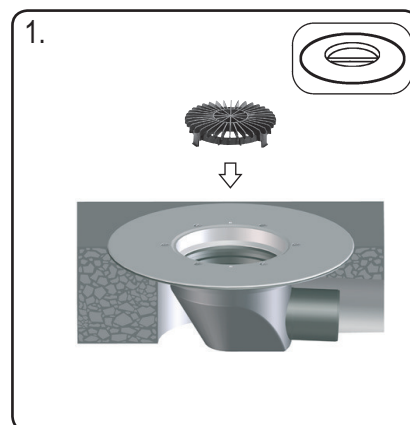
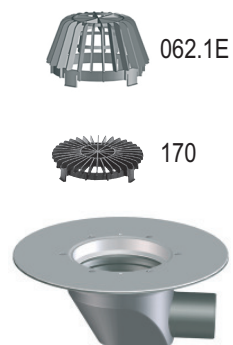

D Flachdach-Ablauf
I Scarico per tetti piani
GB Flat-roof drain

TR Düz çatı süzgeci
CZ/SK Střešní vtok
EX-YU slivnik za ravni krov

H Lapostető lefolyó
PL Wpust dachu płaskiego
SLO Odtok ravne strehe

RO Scurgere de pe terase
PYC Воронка для плоской кровли
BUL воронка за плосък покрив

10.06.2010