

EVERTILE

STONE COATED STEEL ROOFING TILES



INSTALLATION GUIDE **COPPO**

1. These instructions will help with the installation of a simple roof. For installations of a more complicated roof, it's recommended to hire an authorized roofing company.

2. The tiles are designed for roofs that pitch range from 15° to 90° depending on the altitude above sea level of the site and the „snow area“.

3. Minimal temperature of the air, as well as the tiles, during installation should be above +5°. In the case that the installation has to be proceeded in temperatures below 5°C, it is necessary to keep the temperature of the material above 5°C until the moment of installation. The surface finish can crack or exfoliate in lower temperatures in the areas of cutting, bending or nailing.

4. The tile is a lightweight material and under windy conditions the un-secured panels can fall down and cause damage and/or injury. Respect the rules for safe work.

5. During storage of the tiles on the site, keep the material away from dust and water, that could leak inside the palettes and between tiles.

6. Stepping on the roof must be minimized. If necessary, step on the bottom section between the profiles, where the tile is supported by a batten. Soft sole shoes are necessary.

7. Tiles should be installed from the ridge to the eaves. Spots for the correct nailing of the tiles, ridges and trims can be found in the enclosed pictures. It is recommended to install just 3 rows of tiles at the same time and resolve all details contained (chimneys, ventilators, etc.) immediately. This prevents further stepping on the installed tiles.

8. The tiles' warranty is valid, under condition of correct installation and use. The warranty is not relating to roofs with incorrect installation, insufficient or missing ventilation, and if it's used other than the original rustless screw-nails or nails and the system accessories. Atypic details shall be made with materials with adequate durability and corrosion resistance along with materials which do not cause an electro-chemical reaction in a contact with the tiles and which do not exude compounds effecting color and changes on the surface finish.

9. Ventilation must be provided with the system ventilators, or other proceeding, backed by technical calculation.

10. Be sure, that tiles are not exposed to permanent contact with construction parts, which contain copper, cement, lime, bitumen, corroded iron, contaminated with carbon blacks from local heating devices, animals excrements and other materials which can chemically attack the surface finish or accelerate corrosion of the tiles. Do not allow any water pouring down on the tiles, contaminated by the mentioned chemicals and materials, too.

WARNING!

Tiles should not be cut with circular saws or grinding wheels because they could burn the anticorrosive protection of the material. It is recommended to use guillotines, hand or electrical scissors only. Paint the cut edges (REP).



Zinc galvanized nails or screws do not reach a lifetime of the tiles and can significantly shorten a lifetime of the roof and pollute its' surface.

NAILS.

Original nails supplied by the manufacturer are rustless and painted. Nails are available in boxes and free (CNF 60mm) packed by 500pcs. Nails are available in coils (CNC 60mm) to be used with pneumatic guns. 4 nails/1 tile are needed for proper fixing. 5 nails/1 tile are recommended for roofs in the hurricane zone.



NO STEP ON TILES



BATTEN DIMENSIONS

Vertical battens (counter-battens) create a ventilation gap (20-50mm) between the diffusion membrane and the tiles. Dimension shall comply to the norm. It is also used to attach the diffusion membrane, which is laid horizontally from eave to the ridge with sufficient overlaps.

HORIZONTAL BATTENS

The size is determined by the distance of the rafters, snow load or wind speed and the slope of the roof. Take into consideration also safe move of the workers on the roof. Minimum size is 30x50mm (1x1,5 inch), if there is a plywood deck over the rafters or very close distance between rafters (less then 750mm).

Recommended sizes of battens are 40x50mm or 40x60mm (1x2 inches). Pay close attention to fixing of the vertical and horizontal battens and use impregnated battens.

INSTALLATION OF THE HORIZONTAL BATTENS

Attach the diffusion membrane under the counter battens, first. Then fix the horizontal battens successively from the eave to the ridge. Lay the first batten 40mm from the eave edge of the counter batten. The second batten should be laid and fixed at a distance 317-357mm. Other battens will be fixed at a distance of 367mm (bottom edges of the battens) and the last batten as near as possible to the ridge. Accurate measuring, spacing, fixing and using straight battens are the important for proper installation of tiles.

EAVE TRIM (ETN)

Eave trims cover the gap between the tiles and the gutters. It is laid on the counter-batten edges. It is recommended to cover the front of the rafters also with an anti-insect protective net.

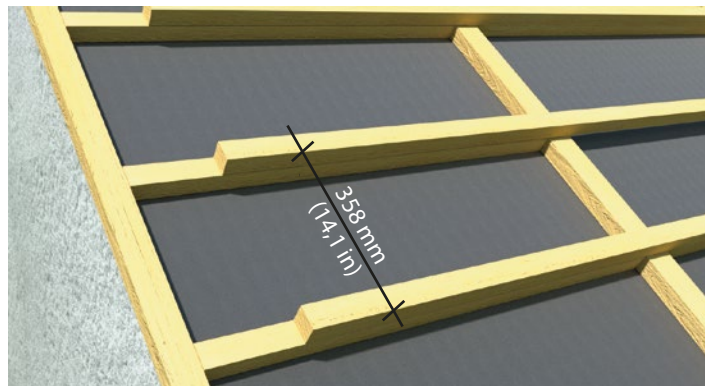

BATTENING - THE RIDGE

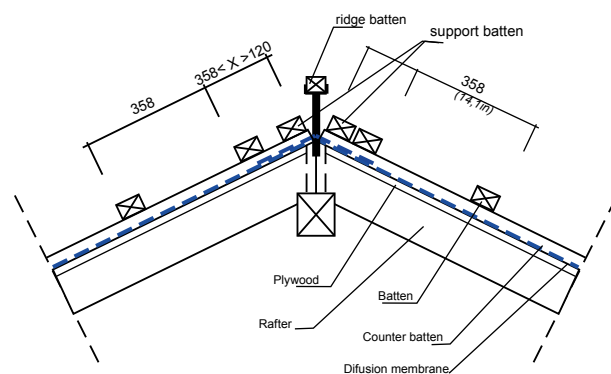

BATTENING - THE EAVE

(Version U.S.A.)

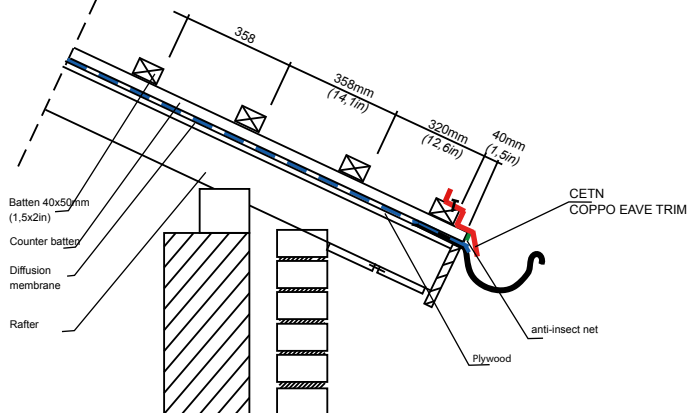

DIRECTION OF THE INSTALLATION

Installation starts from the ridge and continues downward to the eave. All details and accessories will be installed at the same time with the tiles, to avoid stepping on fixed tiles.

WARNING:

Finish all construction works above the roof (chimney, facade,...) before the beginning of installation. Otherwise there is a risk of damage or pollution of the roofing tiles.

FIXING OF TILES

The best way to fix the tiles is to use the pneumatic gun with the original stainless nails (CNC - 60mm). Hand nailing with the original stainless nails is another option, but not so fast and with a risk of damage of the surface of tiles.

Tiles are fixed near the front edge in the spots above a batten – 10-15mm from the front edge and 20-25mm above the low (flat) part of the profile. Every second profile of the tile will be fixed and always the overlap of tiles (4 nails/tile). In the hurricane areas use 6 nails/1 tile.

Make sure, that the nails have a good grip in the battens. The heads of nails should be tight to the tile, but not penetrate or deform the tile.

INSTALLATION OF THE EAVE TRIM

For the correct installation of the trim the first horizontal batten will be laid 20-40mm from the edge of counter battens. The upper section of the trim is placed on the batten, the middle section on the counter-batten and the bottom section enters to / above the gutter. The trim will be fixed by 3-4 nails to the batten and with an overlap of 75-100mm.

ROOF VENTILATION

Roofs with the length of rafters shorter than 10m (30ft), can have one ventilator (CLV90) between two adjacent tiles in the second row of tiles below the ridge. The area of the gap in the eave for air coming in shall be 1/500 of the whole roof area.

If the original ventilators QLV90 are not used, the engineer's calculation must be stated what efficient ventilation was created for maintaining the warranty.

Ventilation area QLV90 is 9000mm²

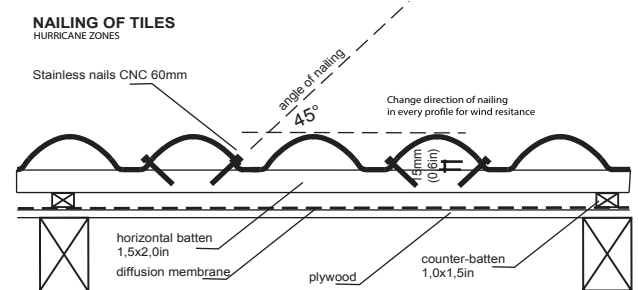
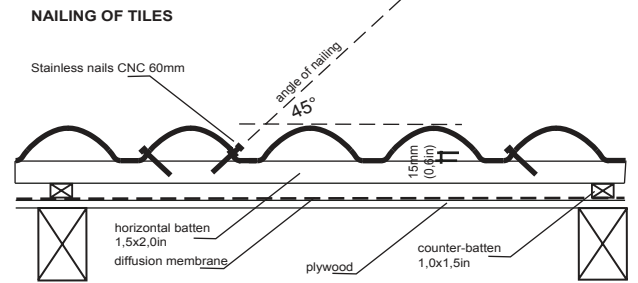

EVERTILE COPPO - POSITION OF NAILS IN HURRICANE ZONES

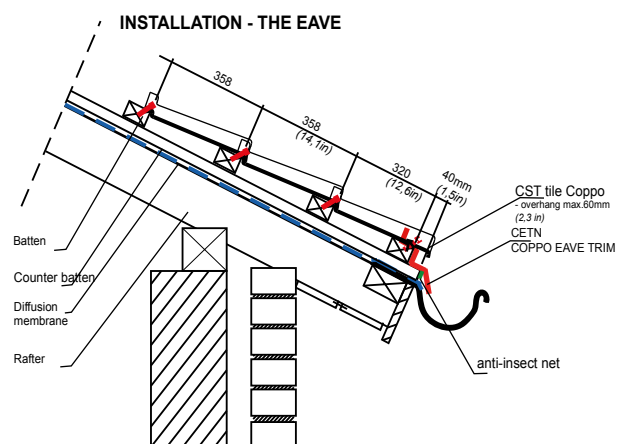
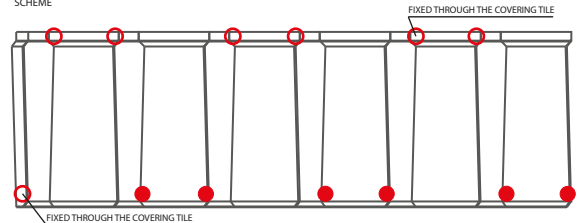

INSTALLATION PROCESS

SADDLE ROOF – START WITH GABLE / WALL EDGES

Installation begins by attachment of the finishing trims (CFT), side wall trims (CSWT) and all flashings around chimneys and dormers. Flashing elements (CFT) or (CSWT) are fixed from outside to the verge batten and by staples to the horizontal battens. The trims are fixed with 10-15mm overlap.

The trims are conic shaped for easy fitting one over the other. Follow the direction of arrows.

START WORK WITH TILES

Installation of tiles begins by attaching the tiles in the first full module row below the ridge. Tiles in the first row must to be attached by 2-3 nails through the upper edge, but the front edges must be left free. After underlaying the bottom row of tiles, the front edge will be fixed, too. The left tile always overlap the upwards profiled left edge of the right tile.

Calculate all the horizontal sections as divided by 200mm. Then, the last profile of the tile in the row will always be heading downwards to the flashing.

Install just 3 rows of tiles at the same time and resolve all details (chimneys, ventilators, etc.), too. This prevents further stepping on the installed tiles.

LENGTH TRIMMING

Tiles on the opposite side of the roof and on the beginning of every second row will usually be shorten. Keep a space of about 20-30mm from the vertical part of the flashing. All cut edges will be finished with a paint from the repair set (REP).

HALF-BOND LAYOUT

The first tile of every second row will be shorten by 2-3 profiles. This will make the tiles lay in "half-bond" and will avoid meeting 4 corners of tiles in one spot. Ventilators and other elements must be installed at the same time, with tiles in the second row (full module) below the ridge.

THE RIDGE

The next step after laying the first two full module rows is to cover the space between the tiles and the ridge batten. The ridge will be fixed, too, before the installation continues. See the chapter "INSTALLATION - RIDGE".

PROCESS OF INSTALLATION

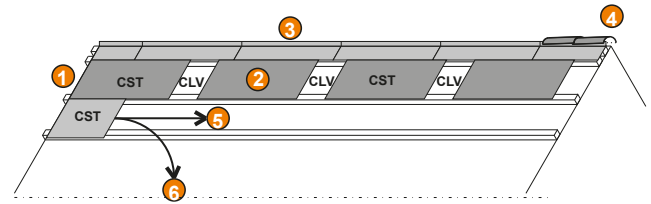

1. Install the finishing trims (CFT);
2. Place the first row of tiles and vents;
3. Connection to the ridge (CUNI);
4. Install the ridge;
- 5 and 6. Continue installing the tiles



CETN - EAVE TRIM

INSTALLATION ON PLYWOOD

Coppo tiles can be installed on plywood, too, with using the plastic „boots“.

The installation starts from the eave. *The eave trim is fixed first on the edge of the plywood board as well as the gutter hooks, etc.* Position of the first row of the boots will be marked according to the position of the tiles towards the gable (finishing trims) and on the edge of the plywood board. When the first line of the boots is fixed (by screws with thread suitable for plywood), place and fix the tiles to the position and insert and fix the second line of the boots. *You can drill the screw through the upper edge of the tile for increasing the wind resistance.*

Normally, fix 1 boot in every second profile. If you need to increase the wind resistance or to make more support for snow load, use 1 boot in every profile.

Boots in the other rows can be fixed the same way - insert and fix into the plywood - while you check permanently that you keep the accuracy of the horizontal lines. Fix the tiles by the original stainless screw-nails (NCS length 45mm) through its' front edge, into the side wings of each boot. Use always 1 nail into 1 boot and change the right side and left side (to increase the wind resistance). Nail always the overlap of tiles.

The eave trim and the gutter hooks are missing on the DEMO pictures.

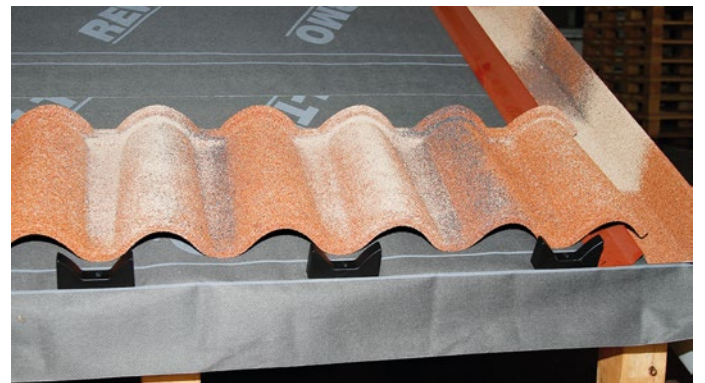

INSTALLATION - RIDGE

CONNECT TILES TO THE RIDGE

After laying the first 2 full module rows, cover the space between the tiles and the ridge batten.

The best option is to use the joining sheet (CUNI), which fits to the profile of tiles and the flat part can be bent and trimmed along the ridge batten.

Another option is to use some universal self-adhesive ridge belt with ventilation.

If the distance to the ridge batten is shorter than the full module, the tiles will be trimmed.

Mark a horizontal line and cut the tile with electric or hand scissors (**No guillotine. No rotation tools!**).

The up-to -measure bent CUNI sheet will be fixed in the upper part to the last batten.

FIXING OF RIDGES.

BR 225 (208 - 225mm).

Wide Bow Ridges will be fixed from the top in the overlay by using 2 nails hammered at an angle of 45° to the vertical axis from each side to the ridge batten

HIPS

Cutting the tiles under angel opens large gaps due to its' profile, which cannot be closed by bending the edges. That's why the hip trim (HT) will be installed below the edges of the tiles.

The bow ridges (BR225) will be fixed on the hip by the same way as on the ridge, from up to down.

COPPO - CONNECTION TILES AND RIDGE

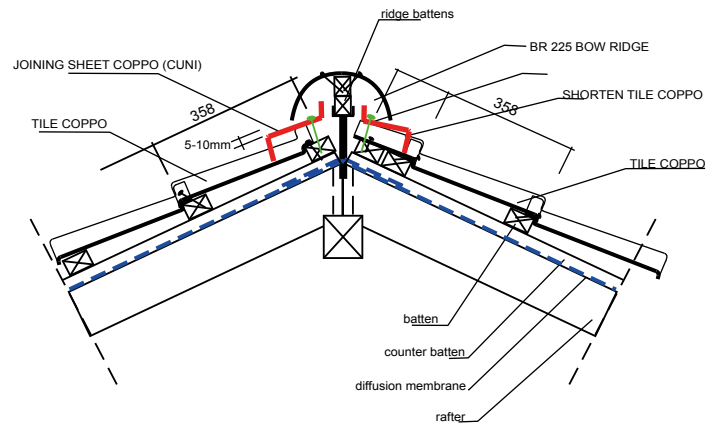

CUNI - bent



HIP WITH BOW RIDGE

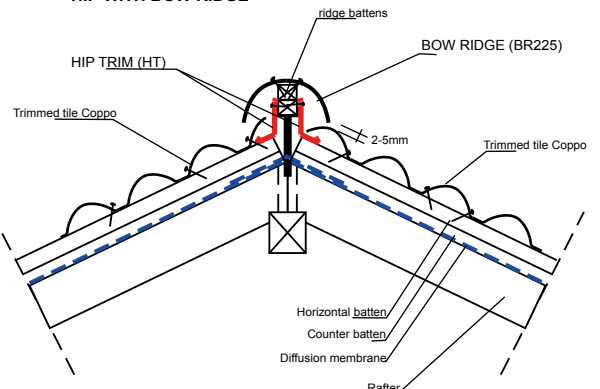

VERGE OF ROOF

The gable trims (CFT or CSWT) will be installed before starting the installation of tiles.

Both are as a bottom flashing, so it shall be embedded in the battens or on the level of the counter-battens.

The trims are "conic" shape, so install them from up to down in the direction of the marked arrow and with overlaps along the water flow – upper element covers the edge of the bottom one.

The gable trims (CFT) or the side wall trims (CSWT) shall be attached to the vertical gable batten and with "staples" to the edges of the horizontal battens (never through the inside flashing area).

When the flashing is ready on both sides of the ridge, install the complete ridge and the installation of tiles can continue down to the eave. All details on the roof must be solved and fixed prior to installation of tiles.

FINISHING TRIMS (CFT)

Finishing trims cover the verges of the saddle or shed roofs. Trims are installed from the eave to the ridge as a bottom flashing and before the installation of tiles. Trims are fixed to the verge battens and on the edges of the horizontal battens by 2 or 3 "staples". Bottom edge of the trim above the gutter shall be cut and bent in order to close its` front gap. Trims are available for either the right or left side and aren't interchangeable.

SIDE WALL TRIMS (CSWT)

Side wall trims finish the verge on the roof to the vertical structure. Trims are available for both right and left sides. The elements are not inter-changeable.

Trims are installed from the eave to the ridge as a bottom flashing and before the installation of tiles. Trims are fixed to the verge batten and on the edges of the horizontal battens by 2 or 3 "staples".

The vertical (flashing) part of the trim shall be left free along the structure and overlaid by a expansion bar (fixed to the structure). The bottom edge of the last trim shall be cut and bent in order to close its` front gap.

FINISHING TRIM

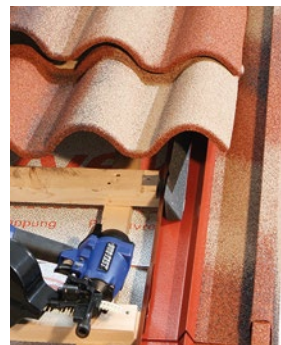
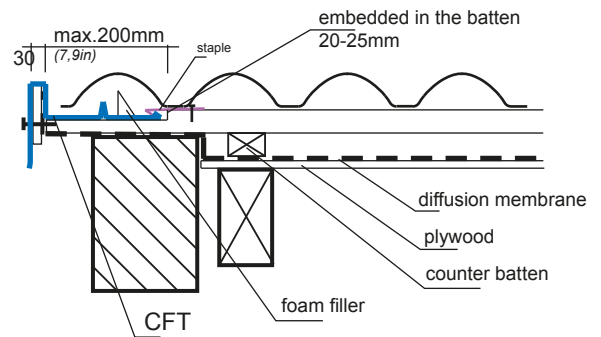

SIDE WALL TRIM

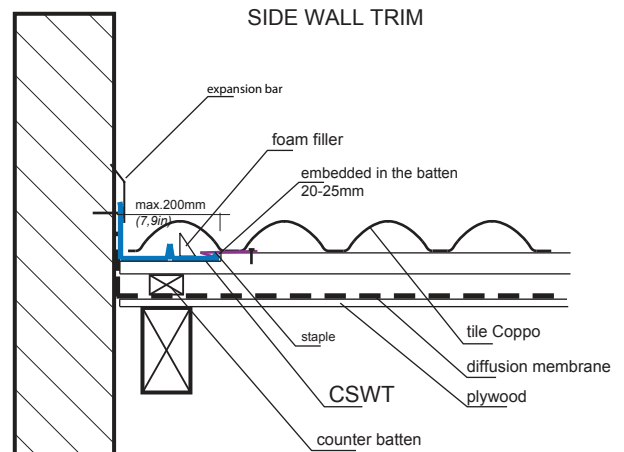

VALLEY, CHIMNEY AND WINDOW

VALLEY

For water and snow diversion, it is possible to use the original valley sheet designed for COPPO (CVY or CVYN) with a smooth surface. The valley will be laid on the level with counter-battens. Then the edges of tiles will be laid over the valley sheet and filled with a foam filler band.

The valley sheet is conic-made. It can be used in one direction only. Follow the arrow mark on the bottom side, which shows the direction from up to down (water flow).

The valley sheets will have vertical overlay 100-150mm according to the roof slope. The valley sheets will be fixed with "staples" only to horizontal battens (never fixed through the bottom flashing part).

It is difficult to trim the edges of tiles perfectly straight along the valley middle groove. The supplementary part is the top cover trim (CVYN+T), which will cover the gabs.

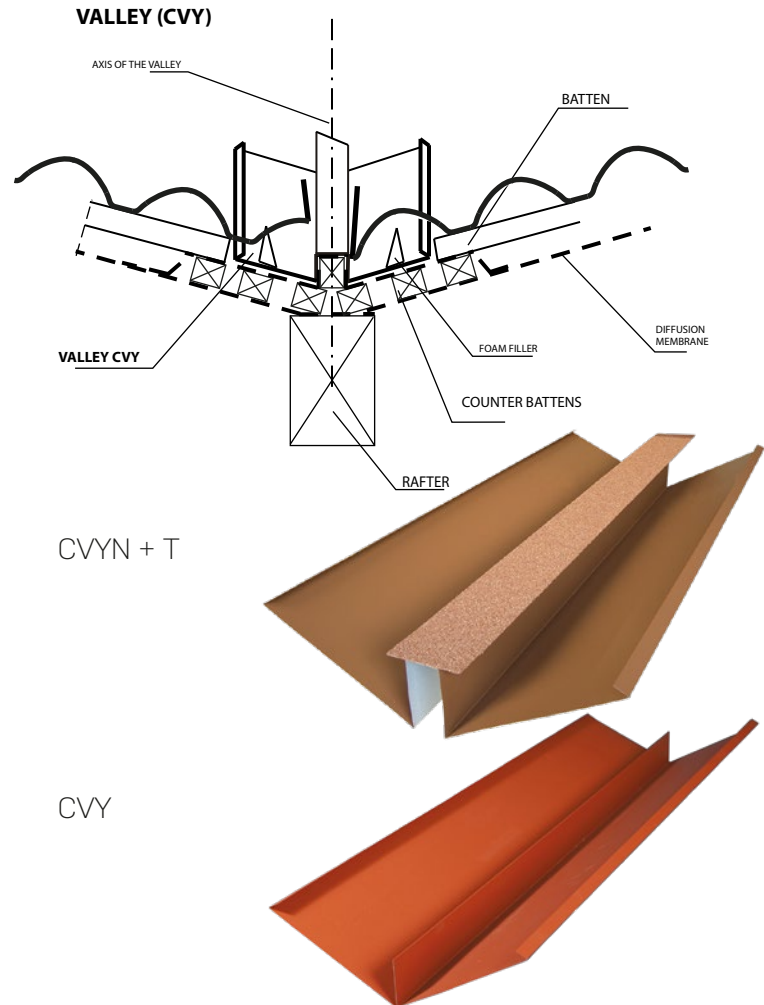
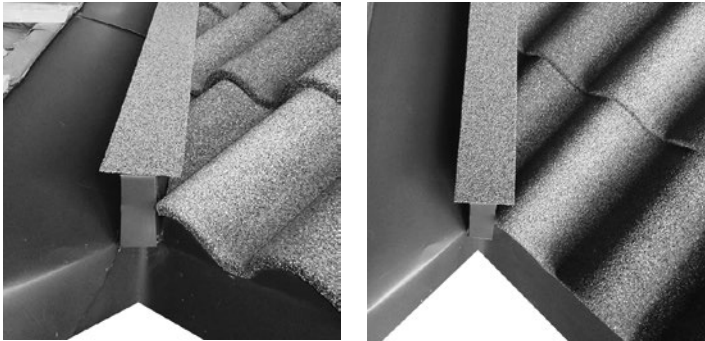

CHIMNEY FLASHING

The flashing around chimneys will be imbedded in the battens or in the level of the counter-battens.

Side flashing shall be made with CSWT trim or with the flat steel sheet VST (to be measured and prepared on the site, like for any other roofing tile). The upper edge of the flashing has to be bended and finished on the nearest horizontal roof batten and overlaid by tile.

ROOF WINDOW

The installation of roof windows will be made according to the specification of its' manufacturer. The only exception is that the frame and flashings shall be laid on level with the counter-battens in order to avoid lifting the tiles over the flashings.

Bottom flashing of the window has always be finished over the upper edge of the bottom tile.

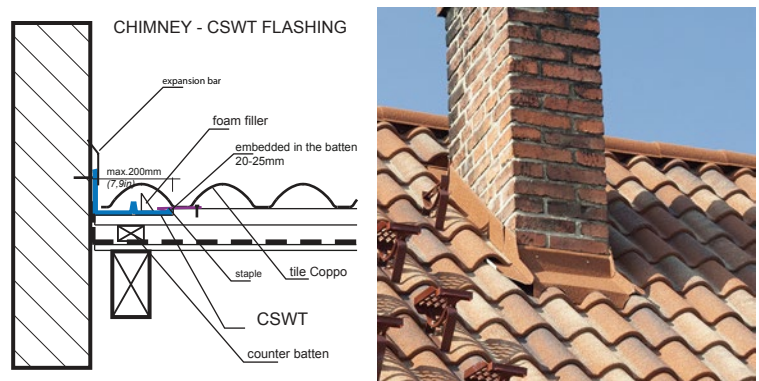

ACCESSORIES

The system of accessories is divided in 2 groups.

1. Accessories with tile shape basement.

Installation of these accessories will be made the same way as the tiles. **The basement of each element must be underlaid below edges of the neighbouring tiles on both sides.**

Before nailing the plastic made accessories drill the spots first, to avoid breaking off the plastic. Important in cold temperatures!

CHV 110 iso - sanitary chimney, Slope of the roof 15°-50°

CGS MULTI – gas fluid weathering tile, Slope 15°-50°

CLV 90 - ventilator plastic 90 cm², Minimal slope 15°

CAZ 16 - tile for antenna

2. Other accessories,

The other accessories are designed for a special function. See the other chapters or ask for advise the official dealer.

CBP - basic plate

CFS - foot step

HSC -holder of solar collector

SNE– skylight

CBLC - UNI - holder of flash conductor

BLC-BR 225 - holder of flash conductor for the ridge



CLV 90



CHV 110 iso

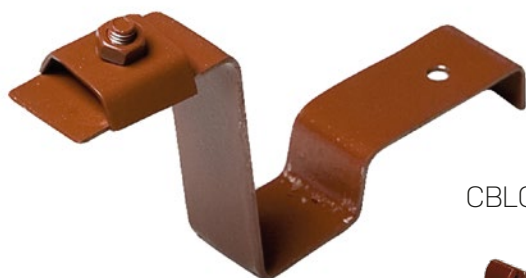

CBLC-UNI

BLC-BR 220

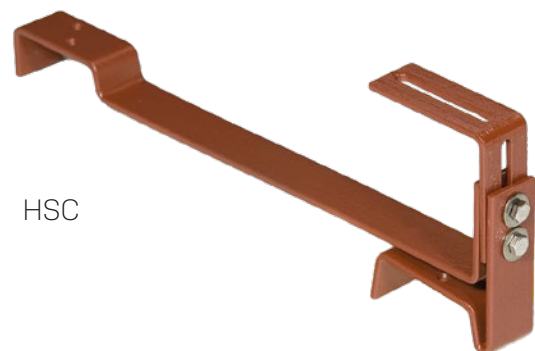
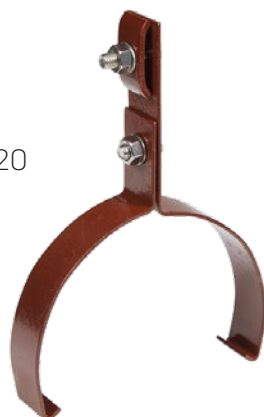

HSC

SNOW BREAKERS

Use the snow breakers (CSBN) in the following cases:

a) Prevention of snow falling from the roof.
Design and dimension depends on the snow territory, slope of the roof, length of the roof and type of the roof covering. (See your national or local norms)

b) Prevention of snow move.
The snow, gliding down the roof can accumulate in details or damage some accessories – roof windows, valley, solar collectors, plastic sanitary vents etc.

Every snow breaker must be fixed with extra screws into the horizontal batten through the upper part.

SAFETY ACCESSORIES

Installation or maintenance of additional technical devices on the roof after finished installation of tiles cause damage of tiles and functional defects on waterproofing.

During installation of the roof, always install the safety accessories (CFSN/CBPN), where necessary. Any other service works must be made from hydraulic platforms.

IMPORTANT!

Every safety element must be fixed with extra screws into the horizontal batten.

CLEANING

Avoid stepping on the roof covering after finishing the installation. Keep the roof clean from lichen. Control and clean the details, which could be filled with dirt (leaves, needles). Use approved biocide chemicals, only. No jet water cleaners are allowed.

All places and details, demanding regular service must be provided with foot steps and walkway grids (CFSN/CBPN).

Change the tiles polluted after installation (due to facade works, etc.). Any mechanical or chemical attempt at cleaning is breaching the warranty and liability of the manufacturer for damages and lifespan of the surface finishing.

SNOW REMOVAL

Remove snow from the roof only in the cases of emergency (too heavy snow layer on limited bearing roof construction, danger of fall to public spaces, cars, etc.). Always keep 150mm of snow cover on the tiles, to avoid mechanical damage of the surface. **Cleaning shall be made from hydraulic platform in order to avoid stepping on the roof.**



SBN



SHS



CFSN



CBPN

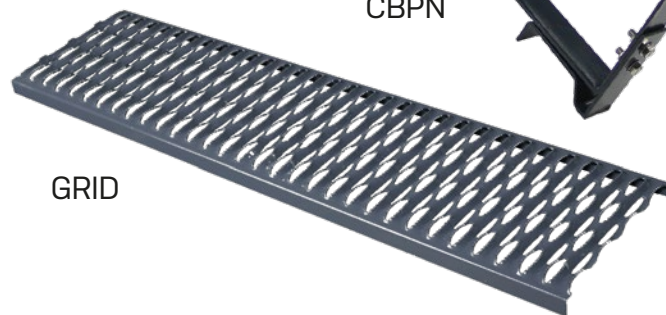

GRID

All safety accessories, snow breakers, flash conductors, etc. are available in colors Anthracite RAL 7016 and Red-Brown RAL 8015. Other colors upon request.

INSTALLATION TOOLS

FINISHING WORKS AND MAINTENANCE

Make a visual control after finishing the installation.
Check the security elements, the foot steps and walkway grids and tightness of all screws.

Spots, where the coating was scratched during installation must be covered with paint (and granules) from the repair set (REP).

INSTALLATION TOOLS

Small roofs can be installed with rustless nails and a hammer. Bigger roofs install with pneumatic guns with rustless and painted nails.

Guns, electric scissors and benders can be bought or rented from the official dealer.

Using the proper installation equipment makes the installation easier, faster, safer and precise.



GENERAL DISTRIBUTOR:
EVERTILE US LLC.
SARASOTA, FL 34236, USA

tel.: +1-941-726-8778
e-mail: info@evertile.net
www.evertile.net