

The Hydraulic Noise, Shock, Vibration and Pulsation

SUPPRESSOR



The small Suppressor makes big improvements to your hydraulic system.

Wilkes & McLean, Ltd.
600 Estes Ave, Schaumburg, IL 60193
www.wilkesandmclean.com



(877) 534-6445
(847) 534-2000
Fax: (847) 534-2016

The Suppressor reduces noise, vibration and pulsation.

What causes noise in a hydraulic system?	3
Why the Suppressor is so effective	4
The Suppressor's patented design	5
Marine, mobile and industrial applications	6
Multiple pump circuit applications	7
How can the Suppressor save you money?	8
It's easy to size and install a Suppressor	9

Suppressor sizes, dimensions and models

700 psi low pressure, high flow Suppressors	10
700 psi low pressure, high flow Suppressors	11
3000 psi Suppressors	12
3000 psi Suppressors	13
5000 psi Suppressors	14
Stainless steel Suppressors	15
BSP Thread, 210 bar and 350 bar Suppressors	16

Accessories and how to charge a Suppressor

Mounting clamps and spare parts	17
Remote charging	18
Charging a Suppressor	19

How to select the right Suppressor

First, locate your maximum system pressure in column 1.

Second, locate your desired connection type in column 2.

Third, locate the size of the connection in column 3.

Fourth, use the brochure page # for the model number and dimensions

1. System Pressure	2. Type of Connection	3. Size of Connection	4. Page #
700 psi	N.P.T. Straight Thread Flange	1", 1.25", 1.5", 2.0"	10
		16, 20, 24, 32	10
		2.0", 2.5", 3.0"	11
3000 psi	N.P.T. Straight Thread Flange	.375", .5", .75", 1.0", 1.25", 1.5", 2"	12
		6, 8, 10, 12, 14, 16, 20, 24, 32	12
		12, 16, 20, 24, 32, 40, 48	13
5000 psi	Straight Thread Flange	12, 14, 16, 20, 24	14
		12, 16, 20, 24, 32	14
Stainless Steel 3000 psi	N.P.T. Straight Thread	.75", 1.0", 1.25", 1.5"	15
		12, 14, 16, 20, 24	15
Metric Connections 210 bar 350 bar	B S P B S P	.375, .50, .75, 1.0, 1.25, 1.5, 2	16
		.75, 1.0, 1.25, 1.5	16

What causes noise in a hydraulic system?

Pump pressure and pump sizes have about equal effects on hydraulic noise levels. However the pump speed has about 300% greater affect on pump noise than either pressure or pump size. This is the reason some pump manufacturers recommend slower electric motor speeds. Fixed pumps are usually quieter then variable displacement pumps.



Pictured are two variable displacement pumps that operate at 1800 rpm. The combination of two pumps operating at a high speed made this a noisy application until the two flange mounted Suppressors, identified by the green bands, were added to the pump outlets.

Lab tests show that pump noise levels are increased by 2 to 3 dB(A) just by adding 12 feet of outlet and return lines. The lines do not generate noise; instead they radiate noise when they respond to pulsations or vibrations. The pump usually generates the pulsations and the vibrations are radiated by large flat machine surfaces.

So not only do hydraulic lines radiate noise but also they frequently provide the primary path for propagating noise from the pump to components. This helps explain why many pump manufacturers have a very low dB(A) pump rating, but when the pump is installed on a power unit the sound rating is much higher.



Shown are two suppressors mounted on the front face of two pumps. Before the suppressors were added this was a noisy installation because the steel floor under the pumps radiated the noise.

It is almost impossible to forecast how much additional sound the hydraulic lines and surrounding structure will radiate. This is why many power units are enclosed after they have been manufactured and installed. Slight adjustments to the nitrogen precharge of the Suppressor will vary the noise control. This is easier than wrapping the piping in sound absorbing tape, or enclosing the entire power unit as an afterthought.

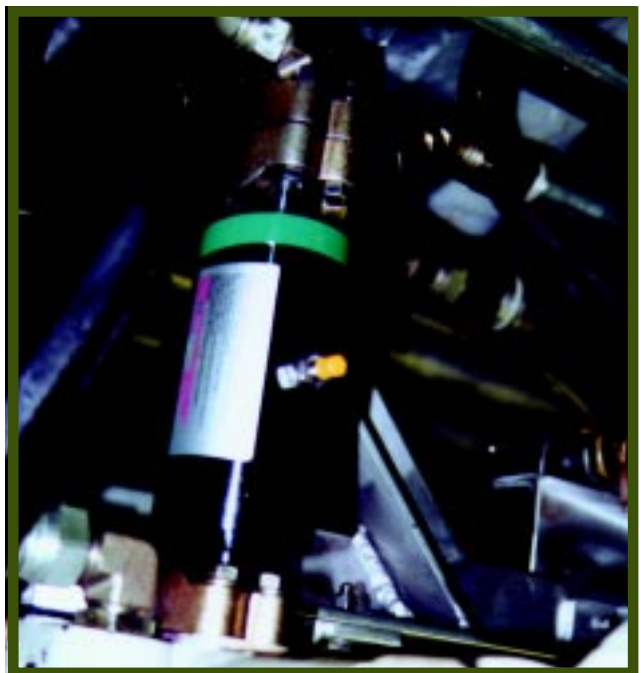

Notice the maze of piping in back of this suppressor. It would have been difficult for a designer to realize that piping would be there and that it carried the sound and vibrations to other parts of the circuit before the suppressor was installed.

Why is the Wilkes & McLean noise and hydraulic shock Suppressor so effective?

The Suppressor is an "in line" device that reduces the noise of any hydraulic power unit. It performs the same function for a hydraulic line as a muffler does on an automobile. It makes the unit quieter by absorbing the sound.

The Suppressor offers a second advantage to a hydraulic system. It also reduces hydraulic pulsations and hydraulic shock. Hydraulic pulsations can cause pump wear and also cause leakage at tube or pipe connections.

Because of the small size of the unit, the most popular size is only 8.25" long, it can easily be installed on any existing power unit. It comes in all pipe sizes; from 3/8" N.P.T. to 2" N.P.T., and all tube sizes; from .375" to 2.0". Flange connections are available in the larger sizes. The Suppressor is usually installed as close to the pump as possible. It can also be installed as close to any source of shock as possible.

Every hydraulic application is different. Field tests have shown that the Suppressor will effectively reduce noise by up to 60%. The Suppressor will also reduce harmonic noise often present in dual pump circuits. The Suppressor will not reduce noise caused by the electric motor, pump coupling, or bearings.

It is no longer necessary to build sound enclosures around power units to isolate noise because the power unit does not meet customer noise specifications. Under most circumstances the Wilkes & McLean Noise Suppressor will take those extra decibels out of the unit.

Noise pollution is the hottest topic in the hydraulic industry today. Automotive companies are reducing acceptable noise standards. The Wilkes & McLean Suppressor helps you meet those stringent new requirements.

Multiple pumps cause more noise.

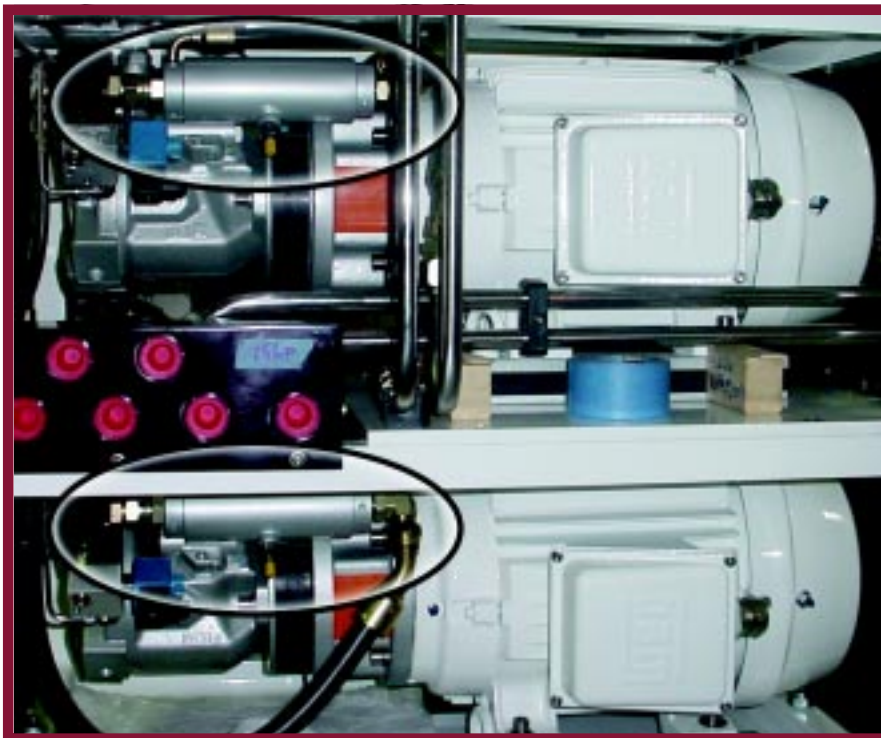

Multiple pump circuits are a major cause of hydraulic noise. This photo shows two pumps mounted on top of each other in order to save floor space on a multimillion dollar yacht. The hydraulic pumps control the fin stabilizer systems for the yacht. In addition to soundproof mounting of the pumps and piping, it was still necessary to use the Suppressors in order to reduce sound levels to acceptable standards.

Sometimes the quality of the sound is as disturbing as the elevated sound level. The sound quality can also be changed by adjusting the precharge of the Suppressor.

The Suppressor's patented design is guaranteed to make any hydraulic system quieter

Suppressor cross section view

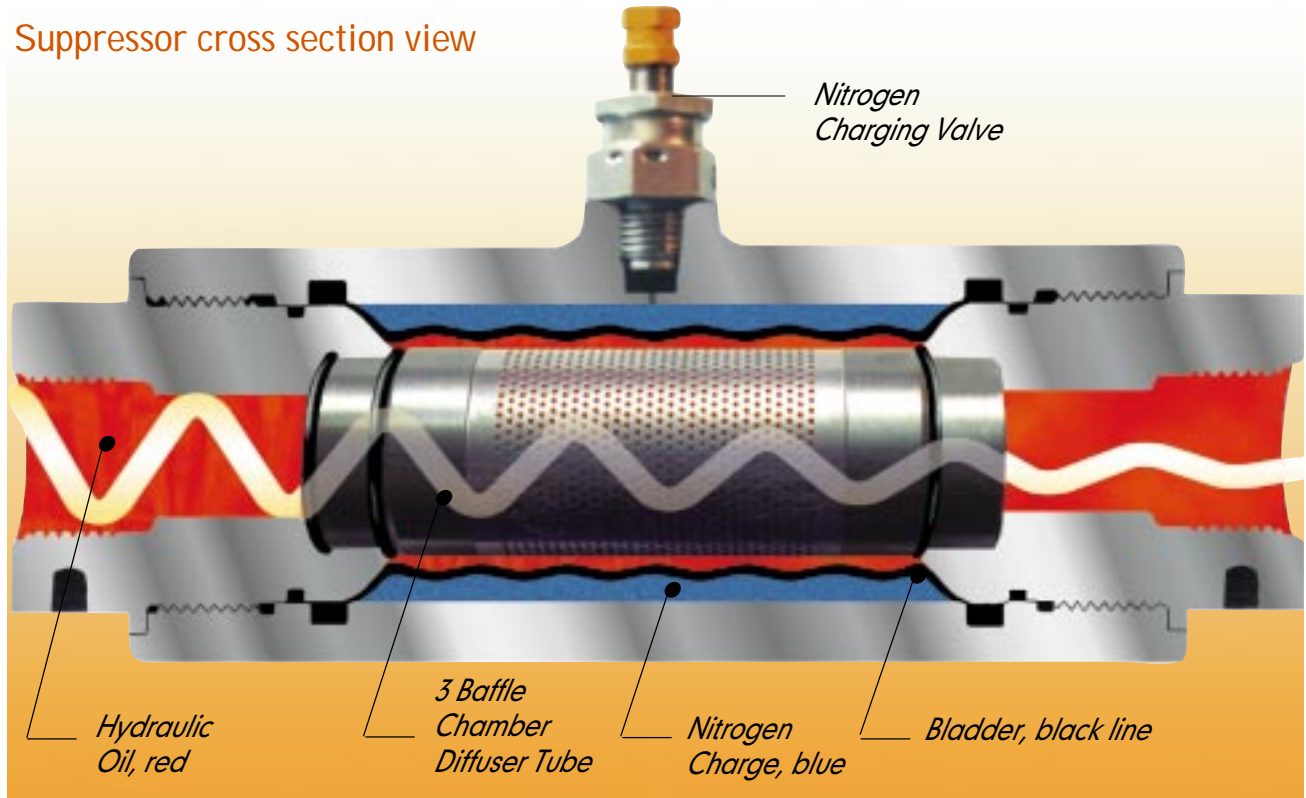

How does the Hydraulic Noise and Shock Suppressor Work?

The hydraulic noise enters the Suppressor and goes through three different noise baffles or diffusers. These metal baffles are designed to convert 1/2" diameter holes to 1/32" diameter holes. The total radial distance through these baffles is only 1/4".

After passing through these holes the noise then strikes the nitrogen charged rubber tube, or bladder. The bladder is usually charged with nitrogen to 50% to 60% of the hydraulic operating pressure. The 1/32" diameter holes are so small that the bladder cannot extrude into them. The bladder deflects each time it is hit by a pulsation. This slight deflection of the bladder reduces the shock and noise.

The large bladder area and the short travel distance combine to absorb high frequency pulsations over 600 Hertz.

Suppressor end view

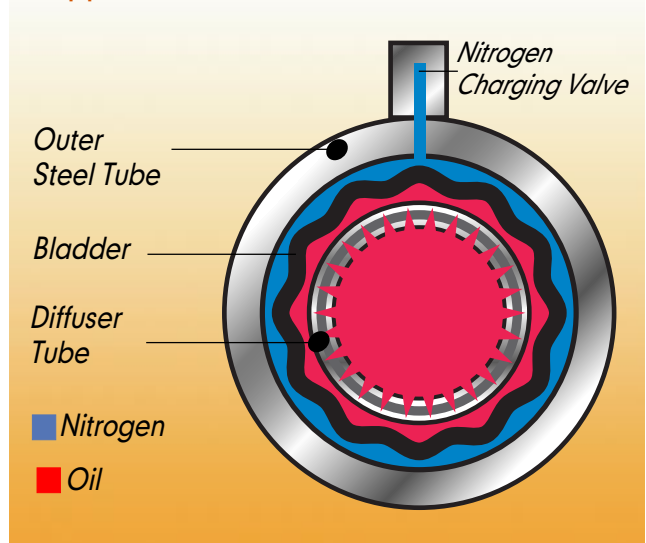

This artist's view of the Suppressor with the end removed illustrates the outer steel shell, the nitrogen charge (blue), the bladder (black), the oil (red) and the diffuser tube.

The Suppressor reduces noise, vibration & pulsation.

The Suppressor is used for industrial, mobile, and marine applications.

Examples of marine applications



America's premier deep-sea research vessel is 36 meters long. It's primary mission is to provide a stable platform for deploying, operating and recovering a tethered, remotely operated, deep sea vehicle which can dive to a depth of two miles.

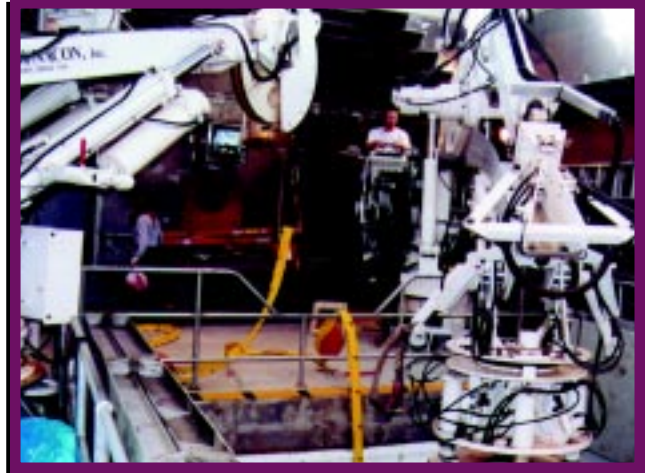

The sound level for these two special cranes, the one on the right for lowering the remotely controlled vehicle into the water and the one on the left for controlling the tether, has been reduced so the two operators can easily talk to each other during operation.

The following shipboard functions all had noise reductions due to the suppressors: deck cranes, special remote vehicle cranes, winches, steering, anchor windlass, and bow thrusters.

This vessel uses 16 Suppressors on every shipboard hydraulic function to reduce noise. The hydraulic pump room has twelve different pumps in it. Some of the pumps are 5,000 psi operating at 1800 RPM.

The pump room is a small all metal room and it radiated noise throughout the entire vessel. The suppressors helped solve this problem.

Ten Suppressors were added to the outlet of the pumps after it was decided that the noise level had to be reduced. (The Suppressors are identified by the green stripe.)

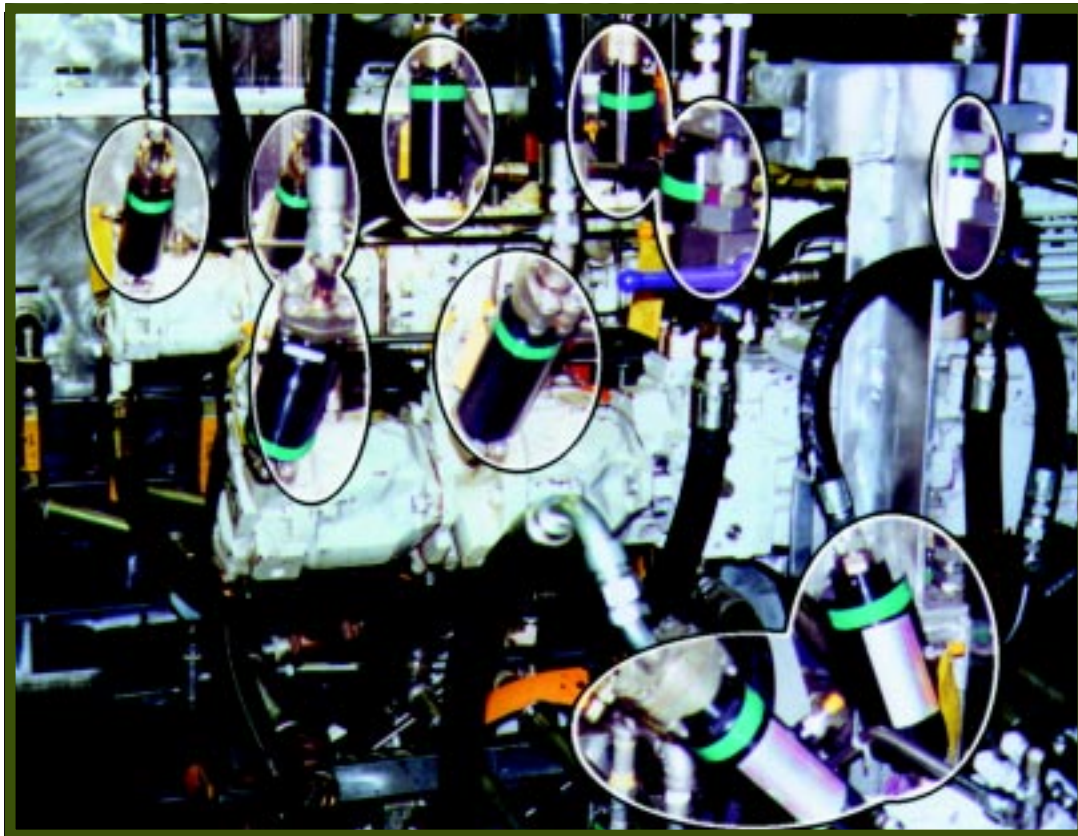

Flange mounted Suppressors in multiple pump circuits

Multiple pumps are a major source of noise.

Large multiple pump flows and large lines usually result in extreme noise levels. The noise level is most evident after the complete installation, when vibrations from multiple pumps resonate off each other, increasing the noise level. Some systems are so noisy they constitute a hearing hazard.

The Suppressor reduces the noise, vibrations and pulsations in hydraulic systems. It is most effective when installed as close to the pump as possible. The Suppressor can even be installed after the original installation.



These six Suppressors quieted multiple flow lines installed in an overhead configuration.



Due to space configuration, these six Suppressors were mounted in the lines leading from the pumps.



The Suppressor shown is a flange mounted Suppressor at the pump outlet.



The original thinking on this installation was that the hoses would dampen the noise and vibrations. When that failed these three Suppressors were installed and the system was quieted.

How can the Suppressor save you money?

Every time you reduce pulsations you reduce noise, leakage, and component wear. Pump pulsations cause vibrations. Vibrations cause leakage. Hydraulic leakage is expensive to clean up. When the Suppressor stops the pulsations it stops the source of the vibrations and the leakage.

“It is not how much the suppressor costs, but what it costs not to use it that counts.”

Save money on new system designs.

Power unit manufacturers can now design a system to operate at 1800 rpm and use a smaller less expensive pump and motor. With the Suppressor they have a quieter and less expensive unit than they would have had at 1200 rpm. In the past the noise and pulsations of the higher rpm restricted their use.

Save money by mounting the suppressor on existing equipment.



This photo shows the Suppressor mounted at the pump outlet. There are sensors mounted immediately before and after the suppressor leading to the oscilloscope. This is the method used to get the tracings shown below.



The new split flange Suppressor mounting makes it possible to break in an existing flange connection and insert the suppressor between the flanges. This makes it easy and fast to try the suppressor in any circuit that has a flange connection at the pump outlet.



The straight thread suppressor is easily added to a run of tubing. There were two tube joints at this location. One was easily replaced with a suppressor.

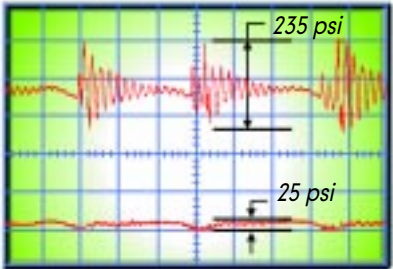

The Suppressor reduces pulsations from a piston pump at 4000 psi at 1800 rpm from 235 psi to 25 psi.

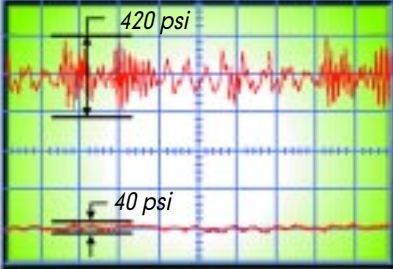

The Suppressor reduces pulsations from a piston pump at 2000 psi at 1800 rpm from 420 psi to 40 psi.

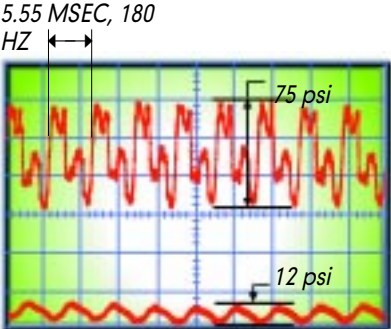

The Suppressor reduces pulsations and noise from a pump running at 750 psi at 1200 rpm from 75 psi to 12 psi and noise from 85 dB to 77 dB.

It's easy to size and install a Suppressor

Sizing is easy

No complex sizing formulas. The Suppressor is sized to match your hydraulic line size. There is a Suppressor for every pipe and tube size from 3/8" to 3".

Port Connections

There are five types of hydraulic line connections for the Suppressor:

1. The N.P.T. pipe port connection from 3/8" to 2" pipe.
2. The S.A.E. port connection from 3/8" to 2" tubing.
3. The Split Flange connection from 3/4" to 3".
4. The Victaulic Flange connection from 2" to 3".
5. BSP threads for Europe from 3/8 to 2.

Types of Suppressors

There are four types of Suppressors:

1. 700 psi rated (see pages 10 and 11 for dimensions)
2. 3000 psi rated for oil operation (see pages 12 and 13 for dimensions).
3. 5000 psi for high pressure oil operation (see page 14 for sizes and dimensions).
4. 3000 psi Stainless for water and chemical operation (see page 15 for sizes and dimensions).

Bladder Materials

The standard bladder material is high temperature HNBR -20° to +250°F. Viton, or EPR bladders, are also available for special applications.

Suppressor Precharge

The Suppressor can be shipped precharged with nitrogen to 50% of your system pressure. It is ready to install in your system. Tests have shown that this is the optimum precharge. Check precharge every 6 months to maintain maximum efficiency.

Mounting the Suppressor

In order to reduce noise and pump pulsations the Suppressor should be mounted as close to the pump as possible. This stops the noise and pulsations before they get into the system and cause vibrations that increase noise levels and also cause leakage at fittings. If the Suppressor is used to reduce shock it should be mounted as close to the source of the shock as possible.

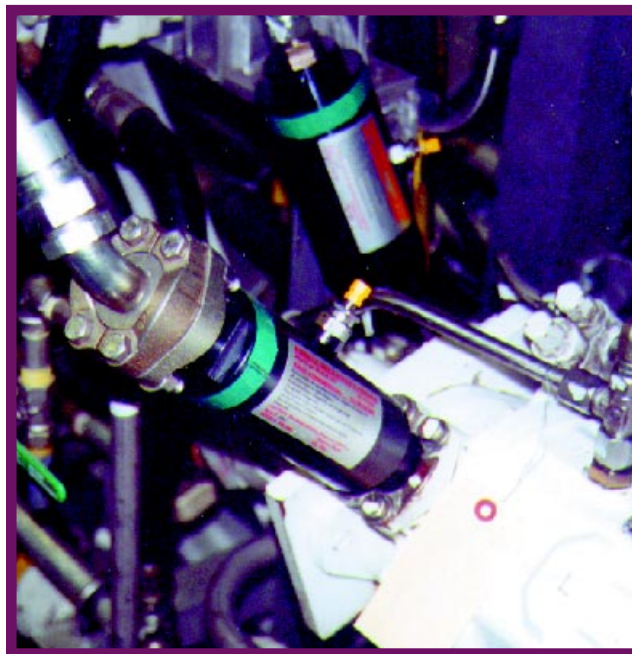

This double pump unit has a flange mounted Suppressor at one pump and a straight thread suppressor at the other pump (identified by green bands). The numerous Suppressor sizes and mountings make it easy to use in any circuit.

How to Order

Specify the Suppressor model number and the operating pressure. The line size and type of mounting will determine the model number as shown on the following pages. The operating pressure is needed if you want the Suppressor shipped with a nitrogen precharge.



This photo shows a typical installation. The Suppressor shown is only 8.25 inches long so it takes very little space.

700 psi low pressure, high flow Suppressors

for N.P.T. Pipe Thread and Straight Thread Connections

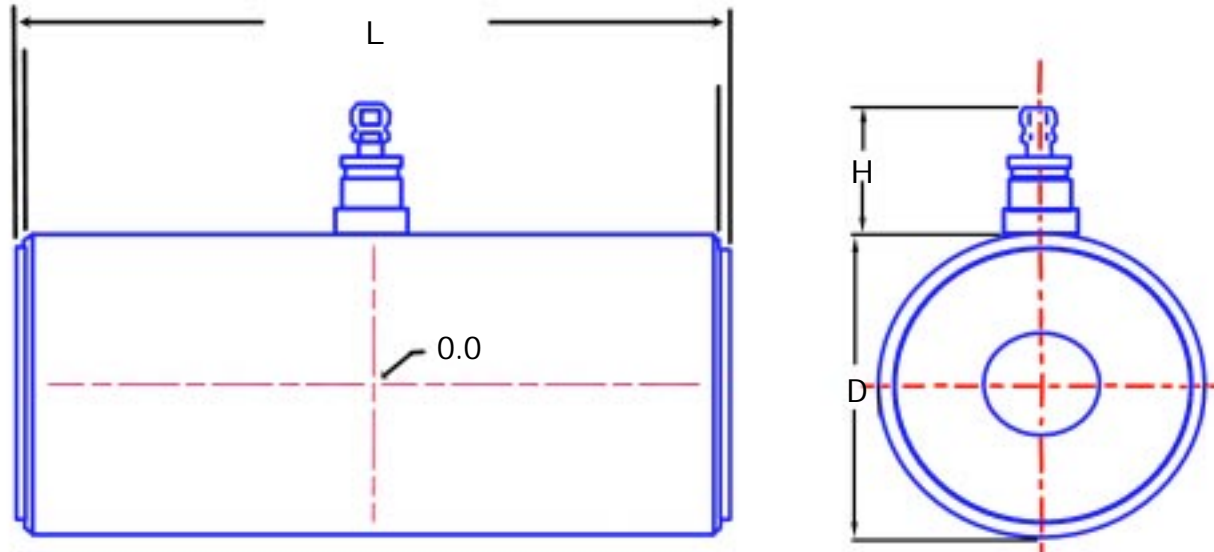

700 psi Suppressors for N.P.T. Ports

MODEL NUMBER	N.P.T. SIZE*	FLOW G.P.M. 15/sec	DIMENSIONS			WEIGHT LBS.
			Diameter	Height	Length	
			D	H	L	
WM 1138 - 1.0	1.00	68.9	3.845	1.75	8.875	21
WM 1138 - 1.25	1.25	68.9	3.845	1.75	8.875	21
WM 1138 - 1.5	1.50	68.9	3.845	1.75	8.875	21
WM 11875 - 1.5	1.50	128	4.595	1.75	10.50	29
WM 11875 - 2.0	2.00	128	4.595	1.75	10.50	29

*For smaller size connections see the 3,000 psi line of Suppressors on page 12.

700 psi Suppressors for SAE Ports

MODEL NUMBER	SAE SIZE*	FLOW G.P.M. 15/sec	DIMENSIONS			WEIGHT LBS.
			Diameter	Height	Length	
			D	H	L	
WM 1138 - 16	1.00	68.9	3.845	1.75	8.875	21
WM 1138 - 20	1.25	68.9	3.845	1.75	8.875	21
WM 1138 - 24	1.50	68.9	3.845	1.75	8.875	21
WM 11875 - 2.0	2.00	128	4.595	1.75	8.875	29

*For smaller size connections see the 3,000 psi line of Suppressors on page 12.

700 psi low pressure, high flow Suppressors

for Victaulic Flange Connections

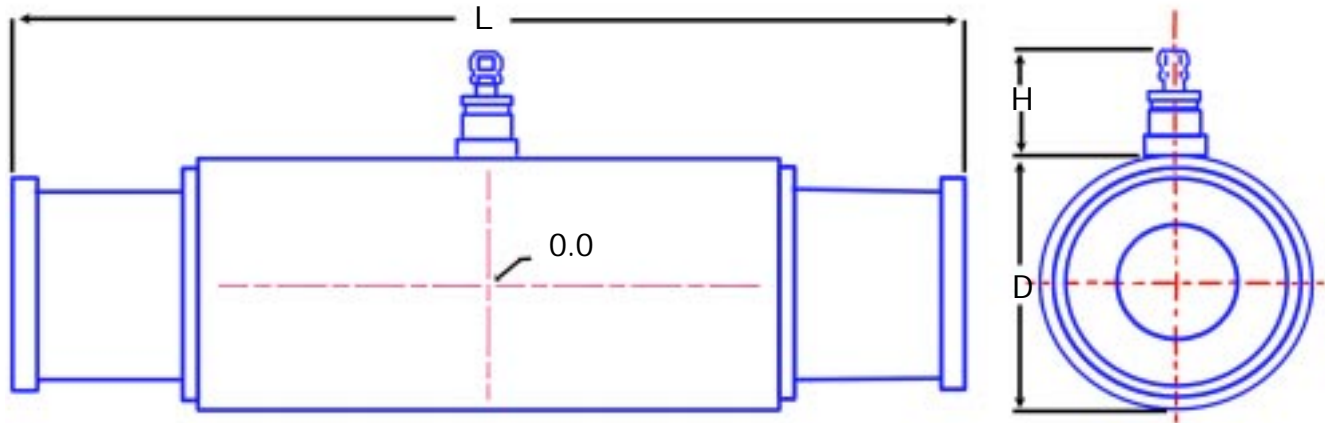

700 psi Suppressors for Victaulic Flange Ports

MODEL NUMBER	FLANGE SIZE*	FLOW G.P.M. 15/sec	DIMENSIONS			WEIGHT LBS.
			Diameter	Height	Length	
			D	H	L	
WM 1138 - 2 SV	2.00	90	3.845	1.75	13.39	25
WM 11875 - 2 SV	2.00	150	4.595	1.75	13.39	28
WM 11875 - 2.5 SV	2.50	150	4.595	1.75	13.39	29
WM 11875 - 3.0 SV	3.00	150	4.595	1.75	13.39	29



Shown above is the 700 psi Suppressor with the flange on each end. The flange is used here because it has a lower pressure rating suitable for the 700 psi Suppressor. The Suppressor can be supplied with any combination of ports, such as SAE port on one end and a flange port on the opposite end. For higher pressure flange mounted Suppressors see pages 13 and 14.

3000 psi Suppressors

for N.P.T. Pipe Thread and Straight Thread Connections

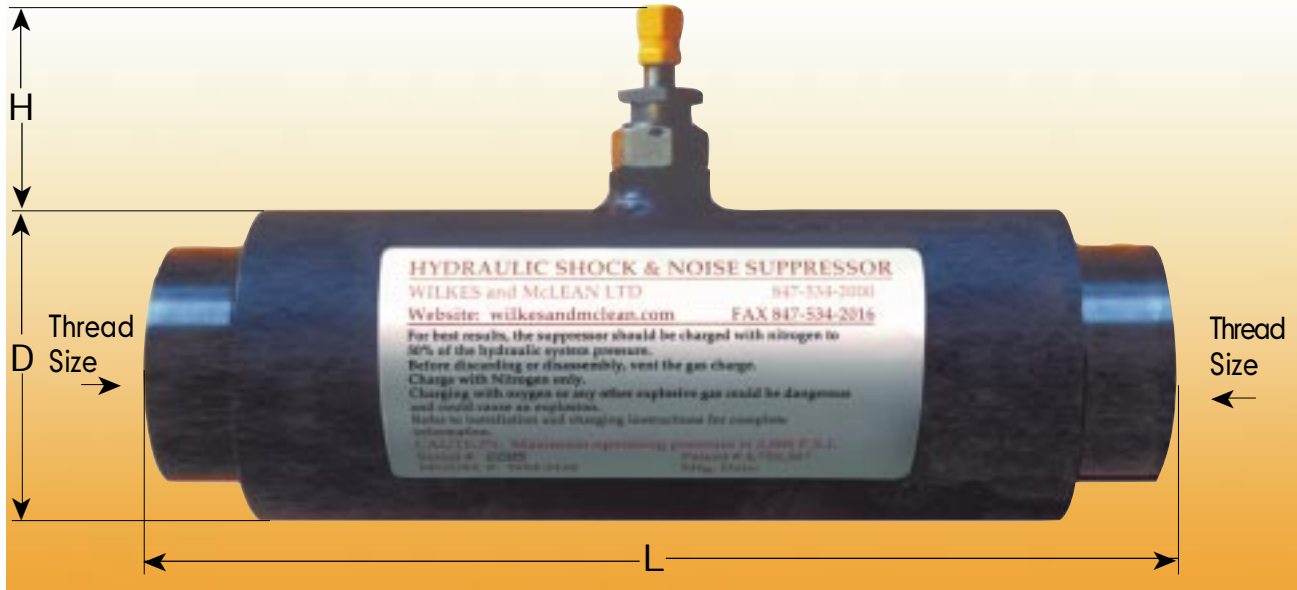

3000 psi Suppressors for N.P.T. Pipe Thread Connections

MODEL NUMBER	N.P.T. SIZE	FLOW G.P.M. 15/sec	FLOW G.P.M. 20/sec	DIMENSIONS			WEIGHT LBS.
				D	H	L	
WM 3056 - .375	.375	11.3	15.1	2.5	1.75	6.875	6.5
WM 3056 - .500	.500	11.3	15.1				
WM 3081 - .75	.750	24.2	32.1	2.625	1.75	8.13	8
WM 3081 - 1.0	1.000	24.2	32.1				
WM 3138 - 1.0	1.000	68.9	91.9	4.125	1.75	8.875	20
WM 3138 - 1.25	1.250	68.9	91.9				
WM 3138 - 1.5	1.500	68.9	91.9				
WM 31875 - 1.5	1.500	128.0	171.0	4.75	1.75	10.5	28.5
WM 31875 - 2	2.000	128.0	171.0				

3000 psi Suppressors for Straight Thread Connections

MODEL NUMBER	TUBE SIZE	STRAIGHT THREAD	FLOW G.P.M. 15/sec	FLOW G.P.M. 20/sec	DIMENSIONS			WEIGHT LBS.
					D	H	L	
WM 3056 - 6	.375	9/16 - 18	11.3	15.1	2.5	1.75	6.875	6.5
WM 3056 - 8	.500	3/4 - 16	11.3	15.1				
WM 3056 - 10	.625	7/8 - 14	11.3	15.1				
WM 3081 - 12	.750	1 1/16 - 12	24.1	32.1	2.625	1.75	8.13	8
WM 3081 - 14	0.875	1 3/16 - 12	24.1	32.1				
WM 3081 - 16	1.000	1 5/16 - 12	24.1	32.1				
WM 3081 - 20	1.250	1 5/8 - 12	24.1	32.1				
WM 3138 - 16	1.000	1 5/16 - 12	68.9	91.9	4.125	1.75	8.875	20
WM 3138 - 20	1.250	1 5/8 - 12	68.9	91.9				
WM 3138 - 24	1.500	1 7/8 - 12	68.9	91.9				
WM 31875 - 32	2.000	2 1/2 - 12	128.0	171.0	4.75	1.75	10.5	28.5

Pressure drop in Suppressor is equal to pressure drop in one foot of tubing.
 To Order: specify model number and operating pressure.

3000 psi Suppressors

for Code 61 and Code 62 Split Flange Mountings

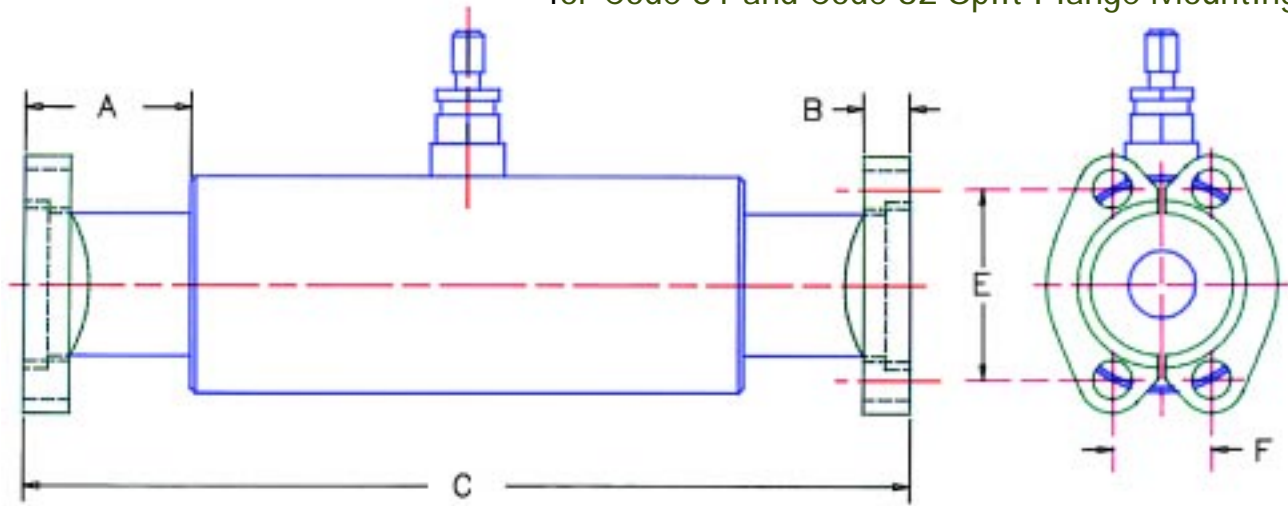

3000 psi Suppressors for Code 61 and Code 62 Split Flange

MODEL NUMBER	FLANGE SIZE	CODE 61 FLANGE DIMENSIONS					CODE 62 FLANGE DIMENSIONS*				
		A	B	C	E	F	A	B	C	E	F
WM 3081 - 12 SF	0.75	1.75	.56	10.12	1.875	0.875	2.000	.75	10.620	2.000	0.938
WM 3081 - 16 SF	1.00	1.75	.62	10.12	2.062	1.030	2.000	.94	10.620	2.250	1.094
WM 3081 - 20 SF	1.25	2	.56	10.62	2.312	1.188	2.250	1.06	11.120	2.625	1.250
WM 3138 - 20 SF	1.25	2.25	.56	13.12	2.312	1.188	2.250	1.06	13.125	2.625	1.250
WM 3138 - 24 SF	1.50	2.25	.62	13.12	2.750	1.406	2.500	1.19	13.625	3.125	1.438
WM 3138 - 32 SF	2.00	2.38	.62	13.38	3.062	1.688	2.620	1.44	13.875	3.812	1.750
WM 31875 - 32 SF	2.00	2.38	.62	15.00	3.062	1.688	none	none	none	none	none
WM 31875 - 40 SF**	2.50	2.875	.75	16.00	3.500	2.000	none	none	none	none	none
WM 31875 - 48 SF***	3.00	3.25	.88	16.75	4.188	2.438	none	none	none	none	none

Split flanges are not included with the Suppressor. Flanges should be ordered as a separate item.

*When ordering Suppressors with code 62 flanges add an X after model number. (Example: WM3138-20SFX)

When using code 62 flanges do not exceed 3000 psi pressure rating of the Suppressor.

**Max. pressure rating for this flange is 2500 psi.

***Max. pressure rating for this flange is 2000 psi.



The Suppressor ends are machined to mate with the standard SAE J518 - code 61 split flange.

The Suppressor is shipped either with or without the split flanges. The Split Flange Suppressor is shipped with an "O" ring face on one flange end and a blank face on the other flange end. This is done so the Suppressor can be inserted between any existing flange connection. When ordering, specify if you want the split flanges shipped with the Sup-

pressor. Specify the system operating pressure. The Suppressor can be shipped with a nitrogen pre-charge to 50% of the system pressure. Suppressors can also be ordered with any combination of ends, such as a split flange one end and a straight thread on the opposite end. When ordering special combinations, specify the type of connection for each end.

5000 psi Suppressors

for Straight Thread and Split Flange Connections

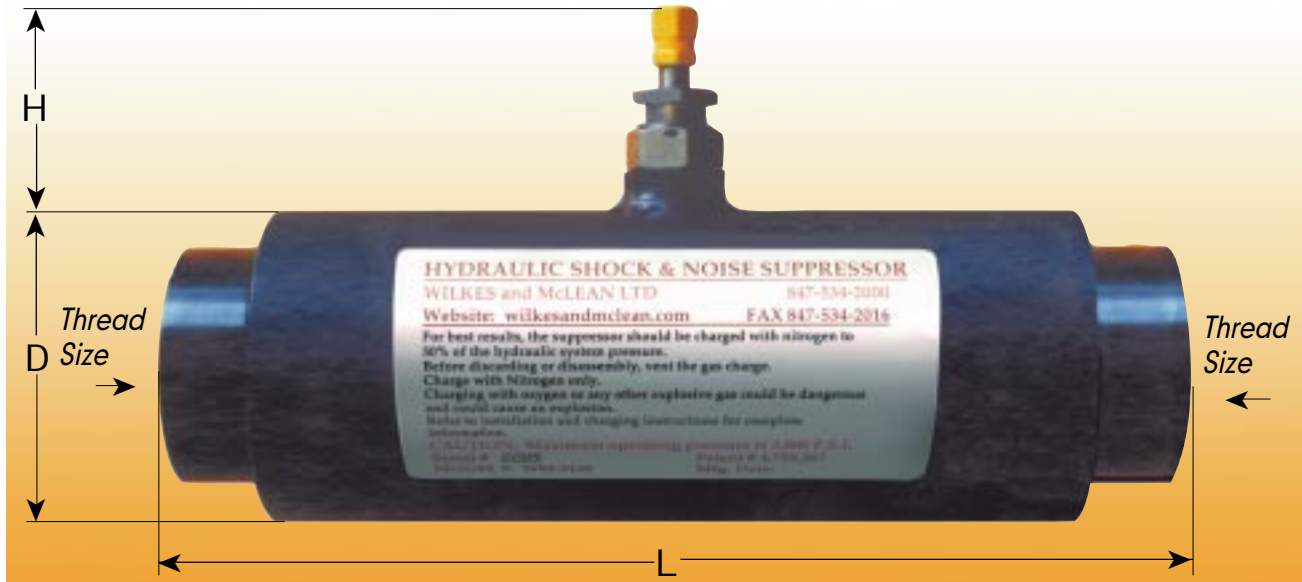

5000 psi Suppressors for Straight Thread Connections

MODEL NUMBER	FOR TUBE SIZE	THREAD IN SUPPRESSOR	MAX. FLOW RATE	DIMENSIONS			WEIGHT LBS.
				D	H	L	
WM 5081 - 12	0.750	1 1/16 - 12	49 G.P.M.	3.50	1	8.13	16
WM 5081 - 14	0.875	1 3/16 - 12					
WM 5081 - 16	1.000	1 5/16 - 12					
WM 5081 - 20	1.250	1 5/8 - 12					
WM 5138 - 16	1.000	1 5/16 - 12	90 G.P.M.	5.0	1	8.88	36
WM 5138 - 20	1.250	1 5/8 - 12					
WM 5138 - 24	1.500	1 7/8 - 12					

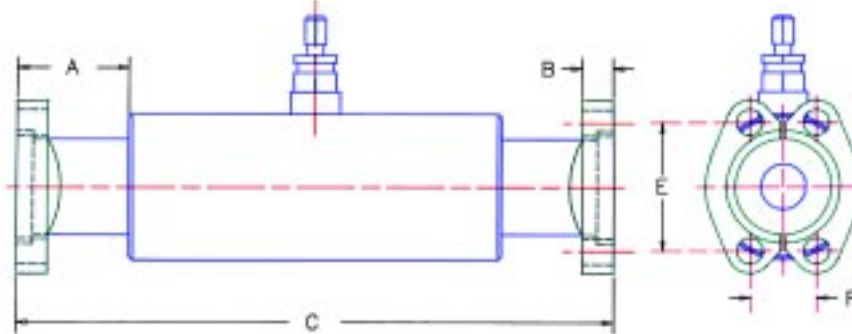

The Suppressor is shipped either with or without the split flanges. When ordering, specify if you want the split flanges shipped with the Suppressor. The Split Flange Suppressor is shipped with an "O" ring face on one flange end and a blank face on the other flange end. This is done so the Suppressor can be inserted between any existing flange connection. Be sure to specify the system operating pressure because the Suppressor can be shipped with a nitrogen precharge to 50% of the system pressure. Suppressors can also be ordered with any combination of ends, such as a split flange one end and a straight thread on the opposite end. When ordering special combination of end connections, specify the type of connection for each end.

5000 psi Suppressors for SAE Code 62 Split Flanges

MODEL NUMBER	FLANGE SIZE	DIMENSIONS				
		A	B	C	E	F
WM 5081 - 12 SFX	0.75	2.00	.75	10.62	2.000	0.875
WM 5081 - 16 SFX	1.00	2.00	.94	10.62	2.250	1.030
WM 5081 - 20 SFX	1.25	2.25	.75	11.12	2.625	1.188
WM 5138 - 20 SFX	1.25	2.25	.75	13.88	2.625	1.188
WM 5138 - 24 SFX	1.50	2.50	.75	13.88	3.125	1.406
WM 5138 - 32 SFX	2.00	2.62	.75	14.12	3.125	1.688

Stainless Steel Suppressors

3000 psi for N.P.T. Pipe Thread and Straight Thread Connections

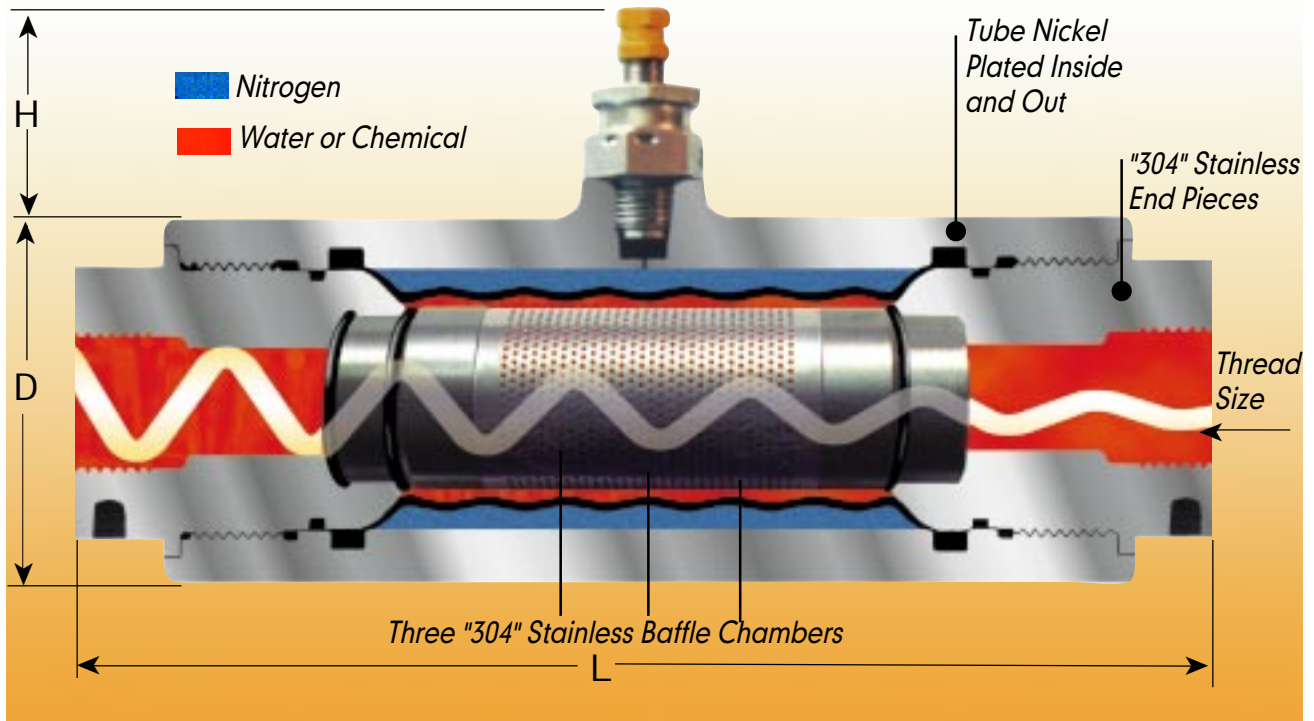

Stainless Steel Suppressors 3000 psi for N.P.T. Pipe Thread Connections

MODEL NUMBER	N.P.T. SIZE	DIMENSIONS			WEIGHT LBS.
		D	H	L	
WM 3081 - .75 SS	0.75	2.625	1.75	8.13	8.5
WM 3081 - 1.0 SS	1				
WM 3138 - 1.0 SS	1	4.125	1.75	8.875	20
WM 3138 - 1.25 SS	1.25				
WM 3138 - 1.5 SS	1.5				

Stainless Steel Suppressors 3000 psi for Straight Thread Connections

MODEL NUMBER	TUBE SIZE	STRAIGHT THREAD	DIMENSIONS			WEIGHT LBS.
			D	H	L	
WM 3081 - 12 SS	0.750	1 1/16 - 12	2.625	1.75	8.13	8.5
WM 3081 - 14 SS	0.875	1 3/16 - 12				
WM 3081 - 16 SS	1.000	1 5/16 - 12				
WM 3081 - 20 SS	1.250	1 5/8 - 12				
WM 3138 - 16 SS	1.000	1 5/16 - 12	4.125	1.75	8.875	20
WM 3138 - 20 SS	1.250	1 5/8 - 12				
WM 3138 - 24 SS	1.500	1 7/8 - 12				

All wetted parts are of 304 Stainless steel.

The tubing is electroless nickel plated on the inside and out.

The standard bladder material is Buna N. Special bladders are available, see page 7.

BSP Thread Connection Suppressors

210 bar and 350 bar (metric dimensions)



BSP Thread Connections for 210 bar Suppressors

MODEL NUMBER	BSP THREAD SIZE	DIMENSIONS (metric)			WEIGHT KG.
		D	H	L	
WM 3056 - .375 BSP	3/8	63.5	44.45	174.62	3.1
WM 3056 - .50 BSP	1/2				
WM 3081 - .75 BSP	3/4	66.66	44.45	206.5	3.6
WM 3081 - 1.0 BSP	1				
WM 3081 - 1.25 BSP	1 1/4				
WM 3138 - 1.0 BSP	1	101.6	44.45	225.43	11.4
WM 3138 - 1.25 BSP	1 1/4				
WM 3138 - 1.5 BSP	1 1/2				
WM 3187 - 1.5 BSP	1 1/2	120.65	44.45	266.7	14.1
WM 3187 - 2 BSP	2				

BSP Thread Connections for 350 bar Suppressors

MODEL NUMBER	BSP THREAD SIZE	DIMENSIONS (metric)			WEIGHT KG.
		D	H	L	
WM 5081 - .75 BSP	3/4	85.85	25.4	206.5	6.8
WM 5081 - 1.0 BSP	1				
WM 5081 - 1.25 BSP	1 1/4				
WM 5138 - 1.0 BSP	1	127	25.4	225.55	21.77
WM 5138 - 1.25 BSP	1 1/4				
WM 5138 - 1.5 BSP	1 1/2				

Pressure drop in Suppressor is equal to pressure drop in one foot of tubing.
To Order: specify model number and operating pressure.

Mounting Clamps

Dimensions

FOR SUPPRESSOR MODEL NUMBER	CLAMP MODEL NUMBER	NUMBER OF CLAMPS REQUIRED	DIMENSIONS					WIDTH
			D	A	B	C	H	
WM 1138	C 3138	1	4.00	7.00	6.30	5.03	2.41	1.25
WM 11875	C 31875	2	4.75	7.00	6.30	5.70	2.78	1.25
WM 3081	C 3081	1	2.62	5.00	3.94	3.75	1.66	1.25
WM 3138	C 3138	1	4.00	7.00	6.30	5.03	2.41	1.25
WM 31875	C 31875	2	4.75	7.00	6.30	5.70	2.78	1.25
WM 5081	C 5081	1	3.38	5.00	3.94	4.48	2.10	1.25
WM 5138	C 5138	2	5.00	7.00	6.30	5.92	2.91	1.25

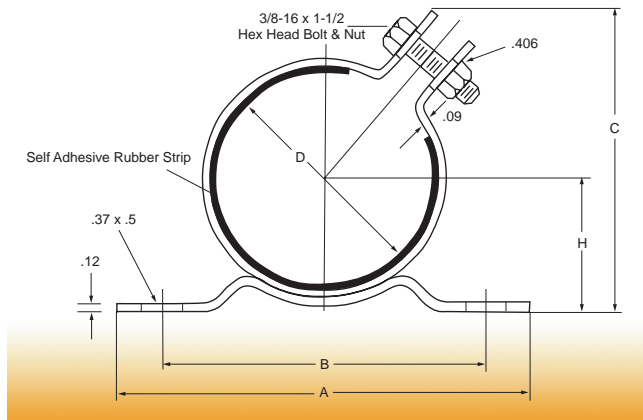

Clamp Model Number C 3081 For Suppressor model number WM 3081.

Clamp Model Number C 5138 For Suppressor model number WM 5138.



Spare Parts

To order specify spare part number and Suppressor model number.

Spare parts are seldom required because there are no moving mechanical parts in the Suppressor, and the bladder barely flexes to absorb pulsations.

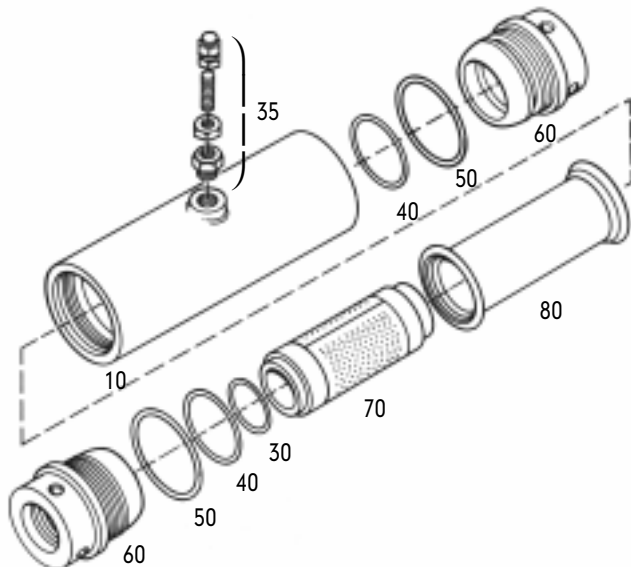

PART NUMBER	PART NAME	ADDED INFORMATION
10	Body	Steel Body
35	Valve Kit 35	Charging Valve
30	"O" Ring (1)	Tube Face "O" Ring
40	"O" Rings (2)	Tube O.D. "O" Ring
50	"O" Rings (2)	End Port "O" Ring
60	End Port	Specify Port Thread
70	Difusser	Only Sold as Unit
80	Bladder Kit	Specify Bladder Mat'l. Shipped with #30, #40, #50 "O" Rings.

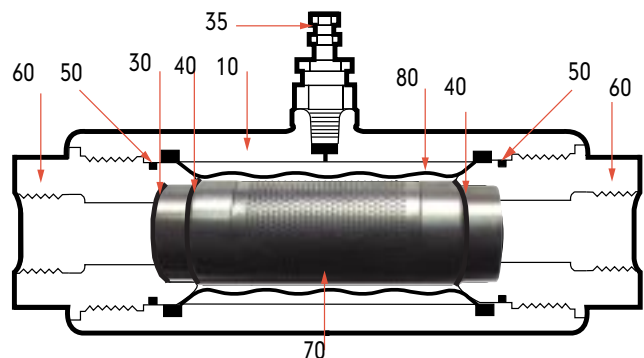

Remote Charging of Suppressors



This remote charging device is a hose which extends the Suppressor charging valve outlet three feet. This allows access to Suppressors mounted in congested locations where charging is difficult. This device can also be used to establish a single charging or pre-charge check location for multiple Suppressors in a congested area.

Precharge Checker



In order to check the nitrogen precharge, and lose as little precharge as possible, the Precharge Checker should be used. The gauge is directly connected to the valve. When the valve is connected to the Suppressor the only nitrogen that escapes is the small amount needed to fill the gauge. This same Precharge Checker can be used for accumulators.

Constant Monitoring of Precharge Pressure

This pressure monitor adapter provides constant monitoring of pre-charge pressure. This pressure gauge is inserted with an adapter between the charging valve and the Suppressor.



Charging a Suppressor

In order to check the precharge it is necessary to have a charging valve (model SV1) and a gauge (G2.5). A hose (H 10) is also necessary if additional nitrogen is required.

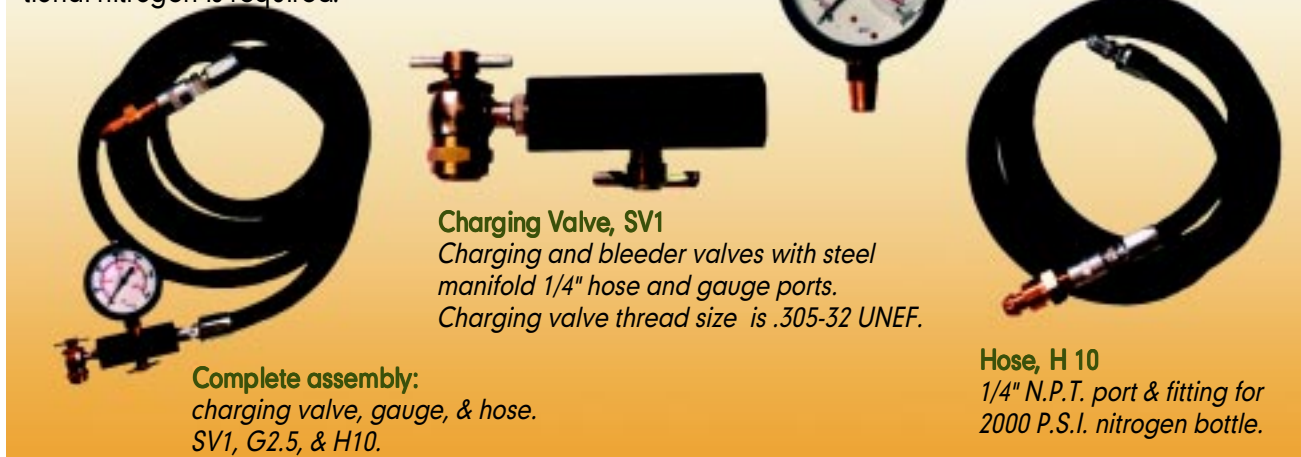

To check the Suppressor precharge:

1. Remove the valve cover, #1, from the Suppressor valve.
2. Thread the Schrader type valve into the valve block. Install a pressure gauge in one of the 1/4" ports. The other 1/4" port, normally used for a hose connection, should be plugged.
3. Thread the Schrader valve and block onto the Suppressor valve. Make sure all connections are tight.
4. While holding the body hex, #3, in place with a wrench, turn the swivel hex, #2, counterclockwise approximately 4 1/2 turns to open the poppet, #4. You can now read the nitrogen charge on the pressure gauge.
5. After reading the nitrogen charge, turn the swivel hex nut, #2, clockwise 4 1/2 turns.
6. Torque to approximately 50 to 70 in./lbs.
7. Remove the Schrader valve block from the Suppressor.
8. Install the valve cover on the Suppressor.

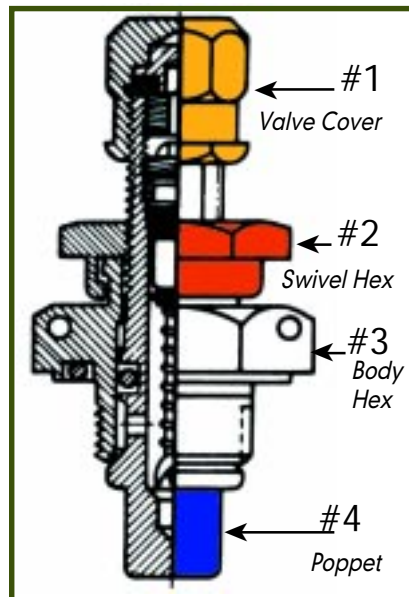

Charging a Suppressor:

1. Remove the valve cover, #1, from the Suppressor valve. While holding the assembly nut, #3, in place with a wrench, turn the swivel hex nut, #2, counterclockwise approximately 4 1/2 turns to open the poppet, #4.
2. Connect the Schrader type charging valve to the Suppressor valve. Since the Suppressor valve does not have a core, there is no need to utilize the T' handle on the Schrader valve.
3. Connect one end of the charging hose to the Schrader valve block and the other end of the hose with the bronze P.O.L fitting to the nitrogen bottle. Open the valve on the nitrogen bottle slowly and allow the pressure to build to the desired level.
4. When you reach the required pressure level, usually 50% of operating pressure, close the valve on the nitrogen bottle.
5. Turn the swivel hex nut on the Suppressor valve clockwise approximately 4 1/2 turns to close the valve poppet.
6. When the poppet has seated, apply approximately 50 to 70 in./lbs. of torque
7. Open the bleeder valve on the Schrader valve block to vent the gas in the charging hose.
8. Remove the Schrader valve from the Suppressor.
9. Install the valve cover on the Suppressor.

The Hydraulic Noise, Shock, Vibration and Pulsation

SUPPRESSOR

The reason multiple pumps cause noise problems is because each pump has its own set of vibrations. Multiple vibrations cause a harmonic resonance which results in unexpected noise. The solution is to use a Suppressor at the outlet of each pump.

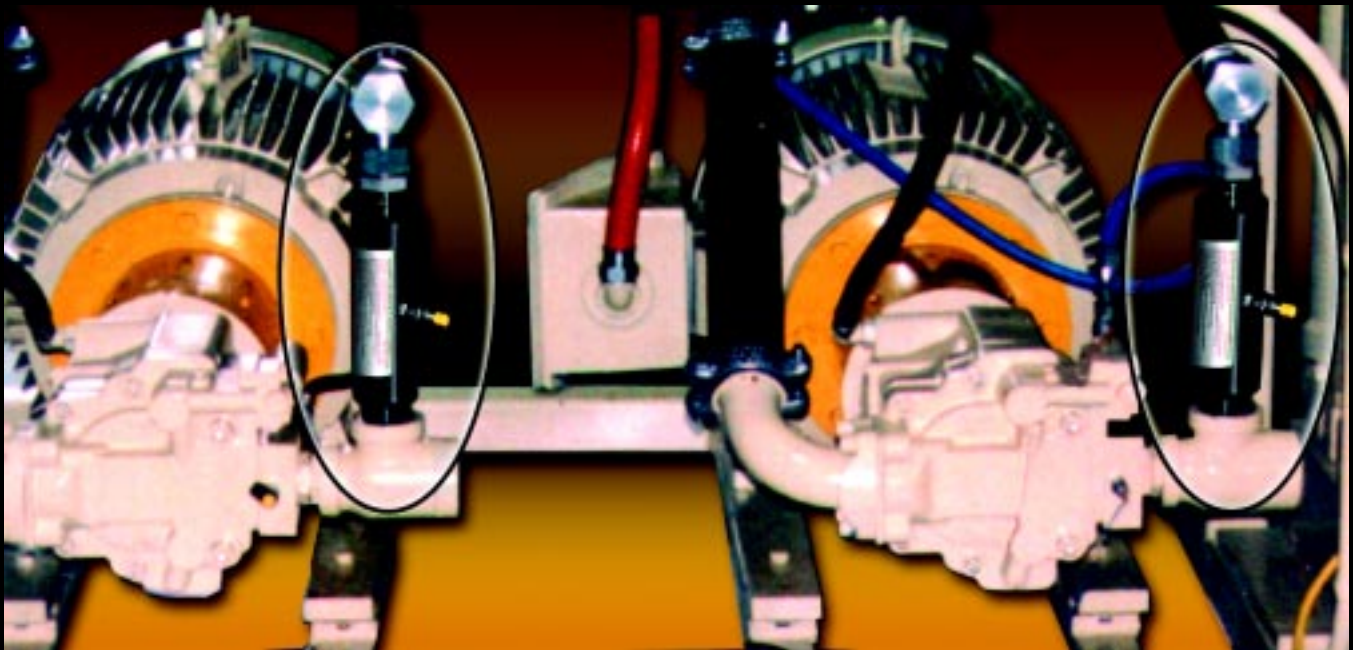

Multiple pumps not only increase the noise decibel level, they can make the "quality of noise" more irritating.

The Suppressor changes both sound level and quality.

Wilkes & McLean, Ltd.
600 Estes Ave, Schaumburg, IL 60193
www.wilkesandmclean.com



(877) 534-6445
(847) 534-2000
Fax: (847) 534-2016