

TECHNICAL DRAWING

GK 1360 S

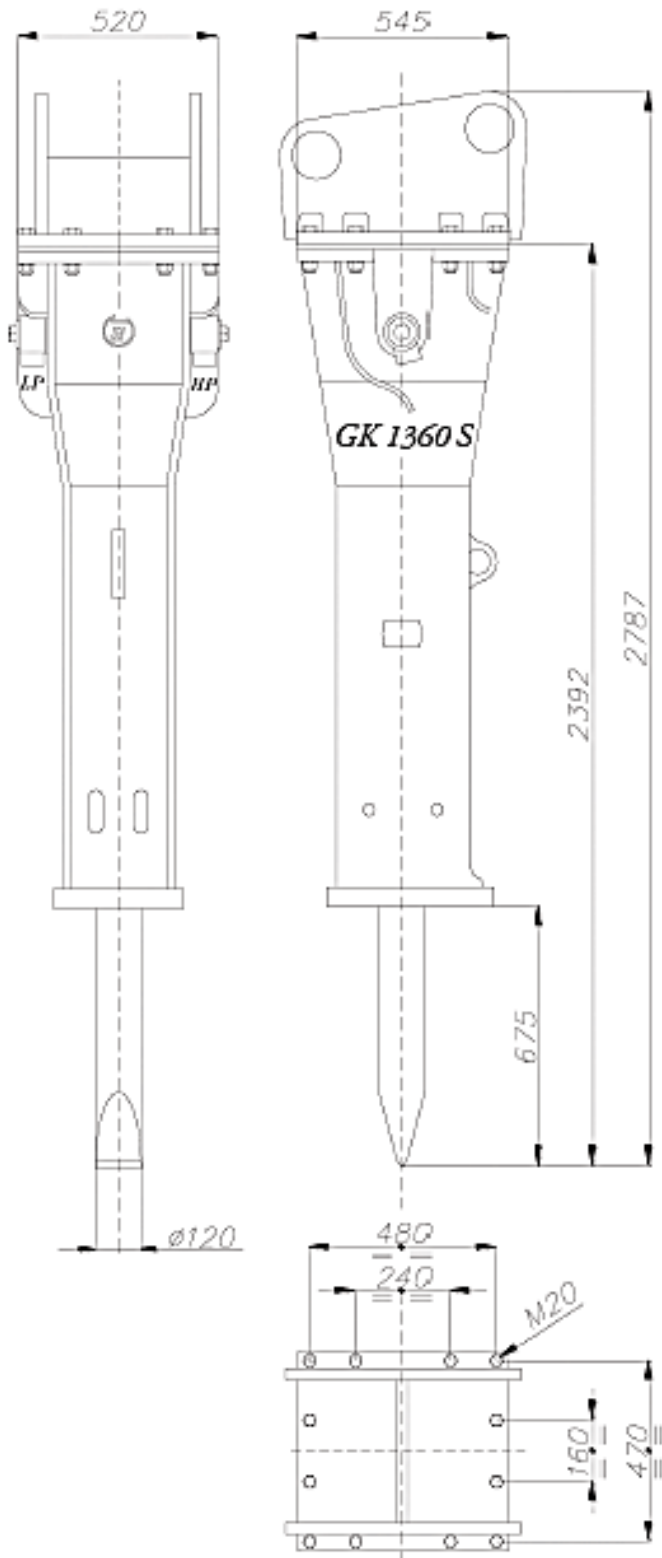

WEIGHT AND DIMENSIONS

Operating Weight	1350 kg
Height	2783 mm
Width	520 mm
Chisel Diameter	120 mm

FITTING TO CARRIER

Carrier weight	180 -250 Ton
Inner Ø HP line	26 mm
Inner Ø LP line	38 mm

At the breaker:

HP thread	1" ¼ GAS
LP thread	1" ¼ GAS

POWER DATA

Power of the breaker	40,5 HP
Required power	50 HP
Yield	0.8
Energy of the blow	3000 Joule
Blows per minute	600 – 750

SETTINGS

Oil Supply	150 -160 L/Min
Working pressure	130 -140 bar
Backpressure	12 bar
Relief valve (carrier)	200 bar
Max. oil temperature	80° C
Nitrogen Pressure	40 bar
Noise level	88 dB-A