

N°	CODE
27	3 CV
28	3 CV
29	3 CV
30	3 CV
31	3 CV
32	3 CV (4 Unit)
33	3 CV
34	3 CV
35	3 CV
36	3 CV (4 Unit)
37	newBCC (2 Unit)
38	newBCC (2 Unit)
39	newBCC (2 Unit)
40	BCC 1-PH 3 CV
40	BCC 3-PH 3 CV
40	newBCC 1-PH 3 CV
40	newBCC 3-PH 3 CV
40	newBCC 3-PH 4 CV
40	newBCC 3-PH 5.5 CV
41	BCC (2 Unit)
42	BCC (2 Unit)
43	BCC (2 Unit)

N°	CODE
13	BCC (8 Unit)
13	newBCC (8 Unit)
14	newBCC (8 Unit)
15	(8 Unit)
16	3 CV (2 Unit)
16	4 / 5.5 CV (2 Unit)
17	3 CV
18	3 CV (2 Unit)
18	4 / 5.5 CV (4 Unit)
19	3 CV (4 Unit)
19	4 / 5.5 CV (4 Unit)
20	(4 Unit)
21	(4 Unit)
24	1-PH 3 CV
25	1-PH 3 CV
25	3-PH 3 CV
26	3 CV

N°	CODE
7	BCC
7	newBCC
8	BCC
8	newBCC
9	BCC
9	newBCC
10	newBCC 3 CV
10	newBCC 4 / 5.5 CV
11	newBCC (8 Unit)
12	(8 Unit)

N°	CODE
1	BCC
1	newBCC
2	
3	
4	BCC
5	newBCC 3 CV
5	newBCC 4 CV
5	newBCC 5.5 CV
6	



INDUSTRIAS MECÁNICAS LAGO S.A.U.
 Pol. Ind. La Rasa - C/ Muntanya, s/n
 17481 Sant Julià de Ramis (Girona) Spain
 Tel. +34 972 17 00 58 - Fax +34 972 17 23 63
 www.imlago.com

EVIDENCE OF CONFORMITY / DÉCLARATION DE CONFORMITÉ / DECLARACIÓN DE CONFORMIDAD / DICHIARAZIONE DI CONFORMITÀ / KONFORMITÄTSEKTLÄRUNG / DECLARAÇÃO DE CONFORMIDADE

- Declares under their own responsibility that all the pumps: **BCC** and **new BCC** Manufactured since 20/04/2011, independent of the serial number, are in compliance with:
 - o 2006/42/CE Machine directive safety prescriptions.
 - o 2004/108/CE Electromagnetic compatibility directive.
 - o 2006/95/CE Low voltage Directive.
- Déclare sous sa seule responsabilité que toutes les pompes modèle: **BCC** and **new BCC** Fabriquées a partir du 20/04/2011, indépendamment du numéro de série, sont conformes avec:
 - o Directive de sécurité de machines 2006/42/CE.
 - o Directive de compatibilité électromagnétique 2004/108/CE.
 - o Directive d'équipés de basse tension 2006/95/CE.
- Declara bajo su única responsabilidad que todas las bombas del tipo: **BCC** and **new BCC** Fabricadas a partir del 20/04/2011, independientemente del número de serie, son conformes con:
 - o Directiva de seguridad de máquinas 2006/42/CE.
 - o Directiva de compatibilidad electromagnética 2004/108/CE.
 - o Directiva de equipos de baja tensión 2006/95/CE.
- Dichiara sotto la sua diretta responsabilità che tutte le pompe del tipo: **BCC** and **new BCC** Prodotte a partire dal 20/04/2011, indipendentemente dal numero di serie, sono conformi a:
 - o Direttiva sulla sicurezza delle macchine 2006/42/CE.
 - o Direttiva sulla compatibilità elettromagnetica 2004/108/CE.
 - o Direttiva apparecchiatura in bassa tensione 2006/95/CE.
- Bescheinigt in alleiniger verantwortung, dass alle Pumpen des typs: **BCC** and **new BCC** Ab 20/04/2011, produziert wurden, unabhängig von der seriennummer, konform sind mit:
 - o Richtlinie 2006/42/CE über die sicherheit von maschinen.
 - o Richtlinie 2004/108/CE über elektromagnetische verträglichkeit.
 - o Richtlinie 2006/95/CE über die sicherheit von electrischen betriebsmitteln (Niederspannungsrichtlinie).
- Declara sob sua única responsabilidade que todas as bombas do tipo: **BCC** and **new BCC** Produzidas a partir de 20/04/2011, independentemente do número de série, são conformes com:
 - o Directiva de segurança de máquinas 2006/42/CE.
 - o Directiva de compatibilidade electromagnética 2004/108/CE.
 - o Directiva de equipamentos de baixa tenção 2006/95/CE.

Signed the present conformity evidence / Signe la présente déclaration / Firma la presente declaración / Firma la seguente dichiarazione / Unterzeichnet diese erklärung / Assina a presente declaração:

Sant Julià de Ramis, 20/04/2011

Signature / Firma / Unterschrift / Assinatura

CJ021060

Carme Fusté Caixàs, Managing Director of Industrias Mecánicas Lago S.A.U.

COUNTER CURRENT EQUIPMENT PUMPS
 POMPES POUR EQUIPEMENT CONTRE COURANT
 BOMBAS PARA EQUIPOS CONTRA CORRIENTE
 POMPE PER IMPIANTI CONTROCORRENTE
 PUMPEN FÜR GEGENSTROMANLAGE

BCC / new BCC

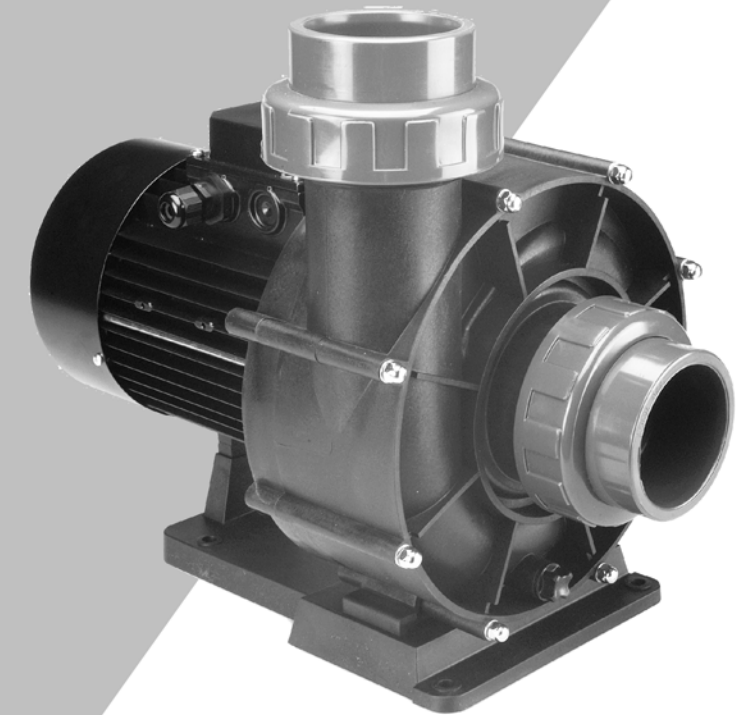

INSTALLATION AND MAINTENANCE, TECNICAL DATA
 MANUEL D'INSTALLATION ET D'ENTRETIEN, DONNÉES TECHNIQUES
 MANUAL DE INSTALACIÓN Y MANTENIMIENTO, DATOS TÉCNICOS
 MANUALE DI INSTALLAZIONE E MANUTENZIONE, DATI TECNICI
 HINWEISE FÜR EINBAU UND WARTUNG, TECHNISCHE DATEN

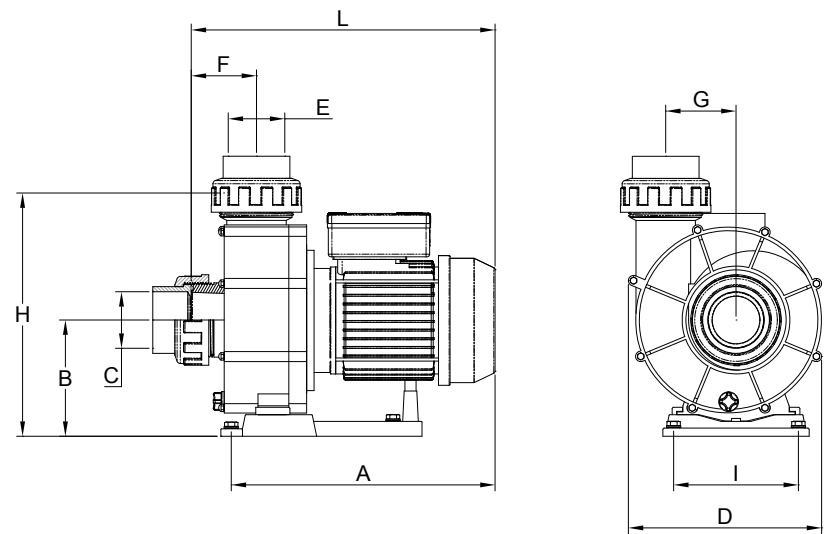

CÓDIGO CODE	POTENCIA POWER		DIMENSIONES / DIMENSIONS									
	kW	CV/HP	mm									
BCC300	2,2	3	235	117	2 1/2"	200	2"	58	65	260	150	390
newBCC300	2,2	3	370	156	Ø75	260	Ø75	77	95	319	168	420
newBCC400	2,9	4	410	156	Ø75	260	Ø75	77	95	319	168	450
newBCC550	4	5,5	410	156	Ø75	260	Ø75	77	95	319	168	450

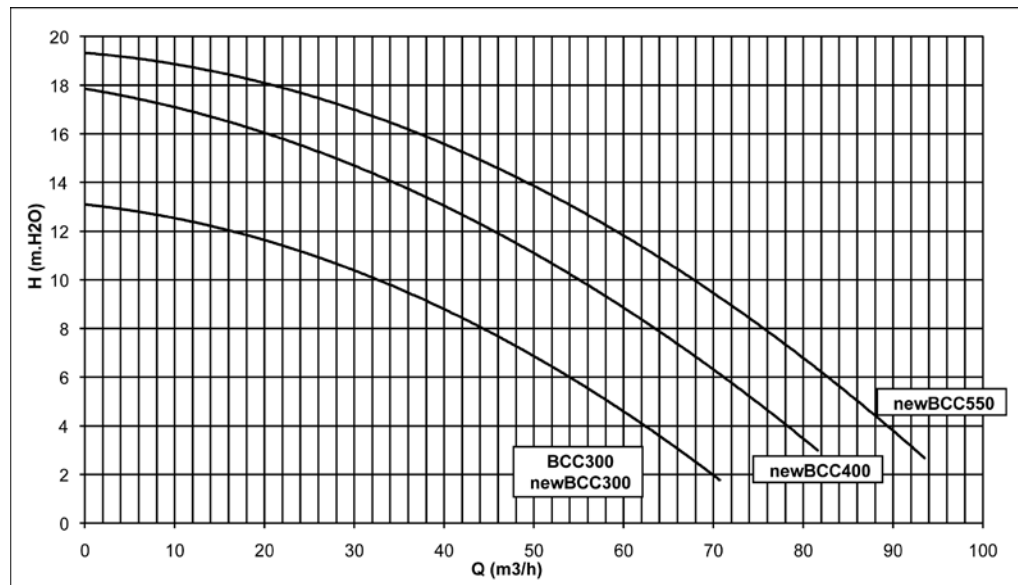

**ELECTRICAL CONNECTIONS - BRANCHEMENTS ÉLECTRIQUES
CONEXIONES ELÉCTRICAS - COLLEGAMENTI ELETTRICI
ELEKTRISCHE ANSCHLÜSSE - CONEXÕES ELÉTRICAS**

**SINGLE PHASE MOTORS - MOTEURS MONOPHASÉS - MOTORES MONOFÁSICOS
MOTORI MONOFASE - EINPHASENMOTOREN - MOTORES MONOFÁSICOS**

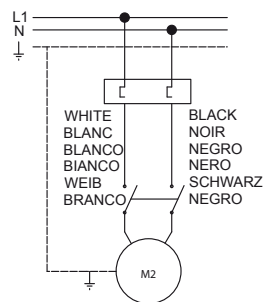
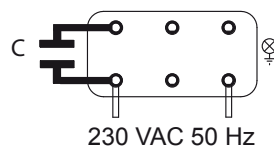

**THREE PHASE MOTORS - MOTEURS TRIPHASÉS - MOTORES TRIFÁSICOS
MOTORI TRIFASE - DREINPHASIGE MOTOREN - MOTORES TRIFÁSICOS**

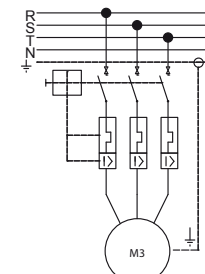
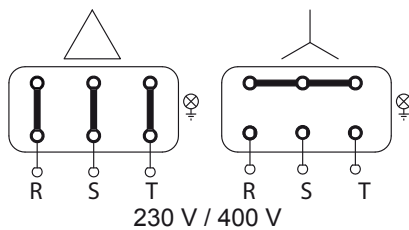

Code	Voltage	Intensity Relay Regulation
BCC300M	230 V	14 A
BCC300T	230/400 V	8 / 4,8 A
newBCC300M	230 V	12 A
newBCC300T	230/400 V	7 / 4 A
newBCC400T	230/400 V	12,6 / 7,3 A
newBCC550T	230/400 V	14,9 / 8,6 A

We reserve the right to change all or part of the articles or contents of this document, without prior notice.

Nous nous réservons le droit de modifier totalement ou en partie les caractéristiques de nos articles ou le contenu de ce document sans préavis.

Nos reservamos el derecho de cambiar total o parcialmente las características de nuestros artículos o contenido de este documento sin previo aviso.

Ci riserviamo il diritto di cambiare totalmente o parzialmente le caratteristiche tecniche dei nostri prodotti ed il contenuto di questo documento senza nessun preavviso.

Wir behalten uns das recht vor, die merkmale unserer produkte und den inhalt dieser beschreibung ohne vorherige ankündigung ganz oder teilweise zu ändern.

Reservamo-nos no direito de alterar, total ou parcialmente características dos nossos artigos ou conteúdo deste documento sem aviso prévio.

ANCHOR DETAIL - DETAIL DE L'ANCRAGE
DETALLE ANCLAJE - DETTAGLIO ANCORAGGIO
VERANKERUNG - DETALHE FIXAÇÃO

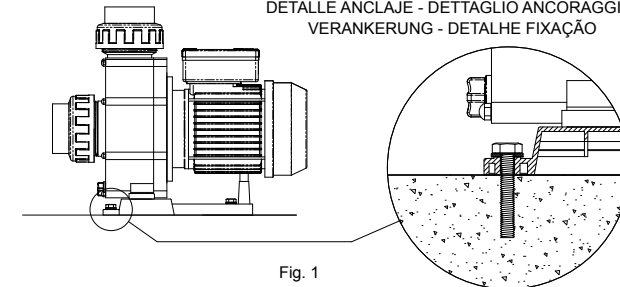

Fig. 1

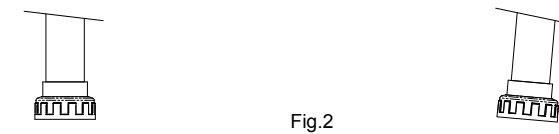
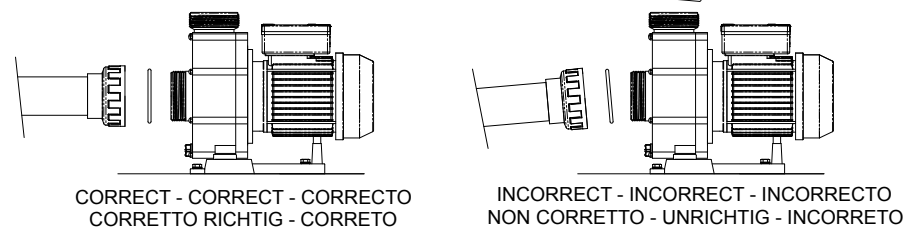

Fig.2



CORRECT - CORRECT - CORRECTO
CORRETTO RICHTIG - CORRETO

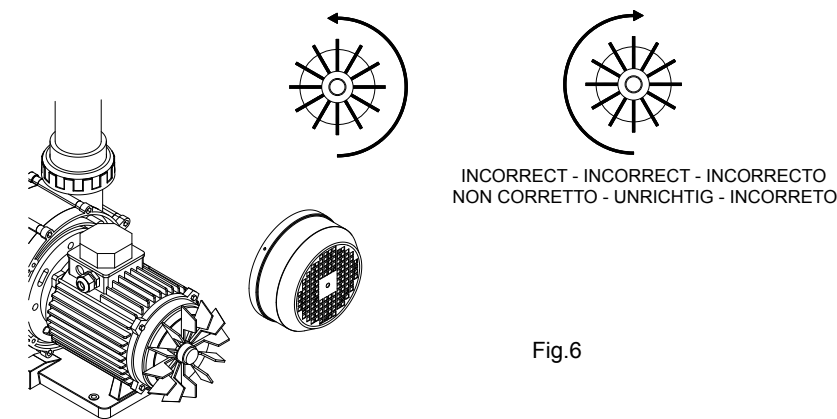

Fig.6

74 dBA		76 dBA		79 dBA	
newBCC300M	newBCC300T	newBCC400T	newBCC550T		
BCC300					