

aus



# Installation instructions

Door Control

TS 970

51171635 b 11.2013

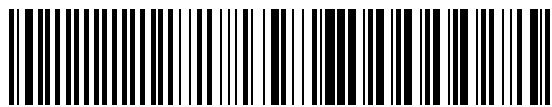

000000 0000 511711635 XXXXX

GfA-ELEKTROMATEN  
Australia Pty Ltd  
P.O. Box 267  
Roseville 2069 NSW  
Telephone: 02 9882 2782  
Facsimile: 02 9882 2783  
Email: [info@gfa-elektromaten.net](mailto:info@gfa-elektromaten.net)  
Web: [www.gfa-elektromaten.net](http://www.gfa-elektromaten.net)

## Additional Information for Australian Installations

### OPERATING INSTRUCTIONS

#### Car Park Function - Self Hold Open / Self Hold CLOSE

Please consider the following in order to achieve automatic closing of your door;

GfA recommends Safety Edge Installation for self closing doors. Our controller monitors a functional Safety Edge and will only permit automatic closing if the controller receives a valid test signal from the safety edge sensor.

If the door supplier decides to operate the door with an alternative safety device (i.e. photo beam), then an end of line resistor (8K2) has to be connected between the controller terminals 2.3 and 2.4.



#### Note!

- Do not connect the end of line resistor without a suitable safety device to protect people and goods from damage when the door is automatically closing!

#### Connection of Photo Electric Beams

A number of devices can be connected to the logic controller. The Photo Beam switching contact should be connected to terminals X6 (6.1, 6.2).

#### Connection Loop Detector

The loop detector should be connected to the terminals 5.2 & 5.3 (N/O).

Contents

<b>1</b>	<b>General safety information</b> .....	<b>7</b>
<b>2</b>	<b>Technical data</b> .....	<b>8</b>
<b>3</b>	<b>Mechanical installation</b> .....	<b>9</b>
<b>4</b>	<b>Electrical installation</b> .....	<b>10</b>
	Connection cable connection overview .....	11
	Carrying out the electrical installation.....	12
	Mains connection .....	13
	Mains connection to control.....	13
	Completing the electrical installation .....	13
	Overview of control.....	14
<b>5</b>	<b>Starting up the control</b> .....	<b>15</b>
	DES: Rapid adjustment of final limit positions .....	15
	NES: Rapid adjustment of final limit positions .....	16
<b>6</b>	<b>Electrical installation – control accessories</b> .....	<b>17</b>
	X1 External supply .....	17
	X3 Emergency stop .....	17
	X4 Automatic closing On/Off .....	17
	X5 Control device .....	17
	X6 Photo cell .....	18
	X6 Light curtain .....	18
	X7 Radio receiver.....	18
	X7 Pull switch.....	18
	X8 Intermediate open .....	18
	X20 Relay contact .....	18
	Spiral cable connection .....	19
	Completing the electrical installation .....	20
<b>7</b>	<b>Control programming</b> .....	<b>21</b>
<b>8</b>	<b>Table of menu items</b> .....	<b>22</b>
	Operating mode .....	22
	Door positions .....	23
	Door functions .....	24
	Safety functions.....	27
	DU / FI settings .....	28

Maintenance cycle counter .....	29
Readout information store .....	30
Clear all settings.....	30
<b>9 Safety devices .....</b>	<b>31</b>
X2: Input, door safety switch .....	31
X2: Input, safety edge system.....	32
X3: Input, emergency stop .....	34
<b>10 Functional description .....</b>	<b>35</b>
X: 24 V DC voltage supply .....	35
X1: Mains supply line for control and external supply .....	35
X4: Input, automatic closing Off/On.....	36
X5: Control device.....	36
X6: Input, through / reflective photo cell or light curtain.....	37
X7: Input, pull switch/radio receiver.....	40
X8: Input, intermediate open On/Off.....	41
X20: Potential-free relay contact .....	42
Force monitoring (DES only).....	42
Travel time monitoring (NES only) .....	43
UBS system .....	44
UBS connection .....	44
Reversing duration adjustment .....	44
Maintenance cycle counter .....	45
Short-circuit/overload display .....	45
Standby function .....	45
<b>11 Status display .....</b>	<b>46</b>
<b>12 Explanation of symbols .....</b>	<b>53</b>
<b>13 Declaration of Incorporation/Declaration of Conformity .....</b>	<b>55</b>

### Symbols



**Warning** - Risk of injury or danger to life!



**Warning** - Danger to life from electric shock!



**Note** - Important information!



**Prompt** - Required action!

Illustrations show example products. Differences from the delivered product are possible.

## 1 General safety information

### Intended use

The door control is intended for a power-operated door with drive unit (NES/DES limit switch system from GfA).

Safe operation is only guaranteed with specified normal use. The drive unit is to be protected from rain, moisture and aggressive ambient conditions. No liability for damage by other applications or non-observance of the instructions.

Modifications are only permitted with the agreement of the manufacturer. Otherwise it will void the manufacturer's declaration.

### Safety information

Installation and initial start-up by skilled personnel only.

Only authorised persons are permitted to work on electrical systems. They must assess the work given to them, recognise potential danger zones and be able to take appropriate safety measures.

Only carry out installation work when the supply has been switched off.

Observe the applicable regulations and standards.

### Coverings and protective devices

Only operate with appropriate coverings and protective devices.

Ensure that gaskets are fitted correctly and that all cable glands are tightened.

### Spare parts

Only use original spare parts.

## 2 Technical data

Series	TS 970	
Dimensions W x H x D	155 x 386 x 90	mm
Installation	vertical	
Vibration	free of vibration Installation	
Operating frequency	50/60	Hz
Supply voltage	1 N~220 V, PE 3 N~220-400 V, PE 3~220-400 V, PE	
Output power for drive unit, maximum	3	kW
Protection per phase, on-site	10-16	A
External supply voltage: (internal electronic protection)	24	V DC
	0.18	A
External supply voltage: X1/L, X1/N (protection via F1 micro-fuse)	1 N~230 V	
	1.6	A time-lag
Control inputs	24	V DC
	type 10	mA
Type of relay contact	potential-free changeover contact	
Loading of relay contacts, ohmic/inductive	230	V AC
	1	A
Control power consumption	10	VA
Temperature range	Operation: -10..+50 Storage: +0..+50	°C
Humidity	to 93 % non-condensing	
Protection class of housing	IP65	
Compatible GfA limit switch	NES; DES	



### 3 Mechanical installation



#### Control installation!

- Indoor use only
- Mount on a level ground free of vibration
- Only mount in the vertical position
- Door must be in clear view from place of assembly

#### Requirements

The permissible loads on walls, mountings, connection and transmission elements must not be exceeded.

#### Mounting

The control is mounted via 4 elongated holes

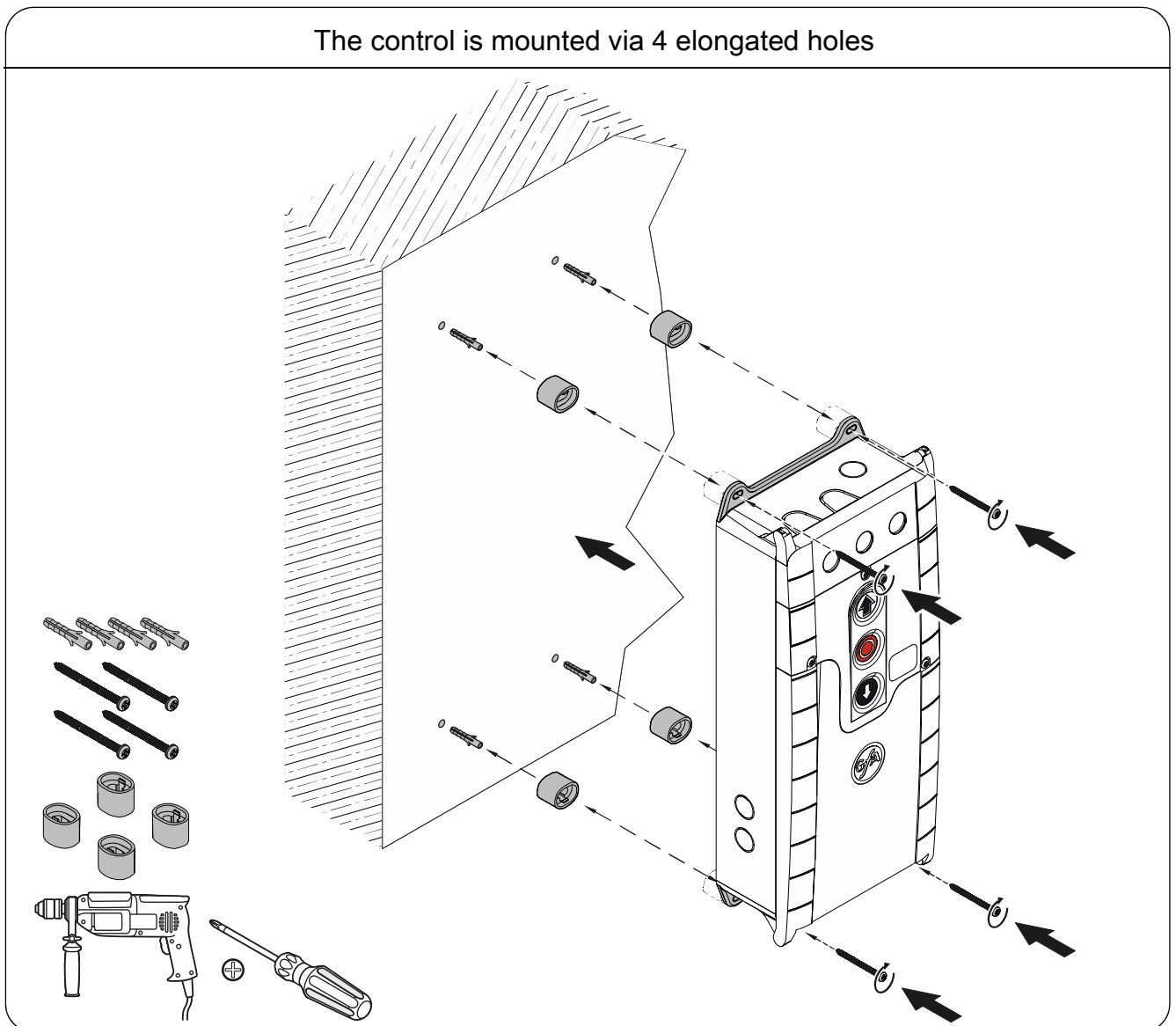

## 4 Electrical installation



### Warning - Danger to life from electric shock!

- Disconnect the cables (mains OFF) and check that the supply is off
- Observe the applicable regulations and standards
- Ensure proper electrical connection
- Use suitable tools



### On-site backup fuse and disconnecter unit!

- Only use current sensitive earth leakage circuit breakers type B for FI-drive units
- Connection to the indoor installation via an all-pole disconnecter unit, with current  $\geq 10$  A as per EN 12453 (e.g. CEE plug connector, main switch)



**Read the drive unit installation instructions!**

## Connection cable connection overview

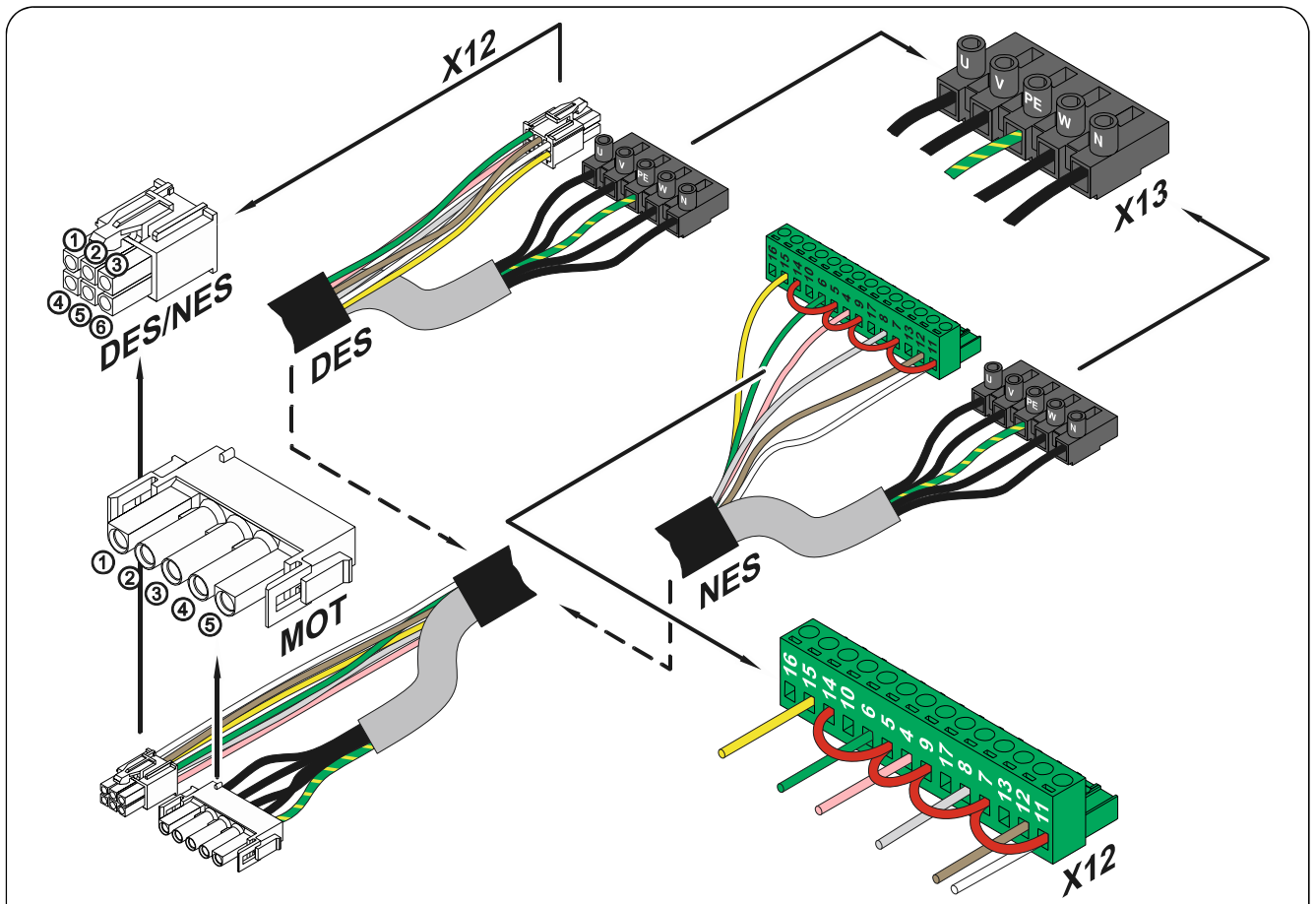

DES and NES Motor connection cable				DES Connection cable limit switch			
MOT		X13	Motor plug	DES		X12	Limit switch plug
Pin	Core	Term.		Pin	Core	Term.	
1	3	W	Phase W	1	5/wh	1	+24 V safety circuit
2	2	V	Phase V	2	6/bn	2	Channel B (RS485)
3	1	U	Phase U	3	7/gn	3	Ground
4	4	N	Neutral conductor (N)	4	8/ye	4	Channel A (RS485)
5	PE	PE		5	9/gy	5	Safety circuit
				6	10/pk	6	8 V DC supply voltage

NES Connection cable			
NES		X12	Limit switch plug
Pin	Core	Term.	
1	5/wh	11	Limit switch common +24 V, wire link on X12 5, 7, 9, 11, 14
2	6/bn	12	S5 Additional limit switch, testing or safety edge function
3	7/gn	6	S3 Open limit switch
4	8/ye	15	S6 Additional limit switch, relay function or intermediate open
5	9/gy	8	S4 Closed limit switch
6	10/pk	4	Safety circuit

## Carrying out the electrical installation

- ▶ Remove covers.

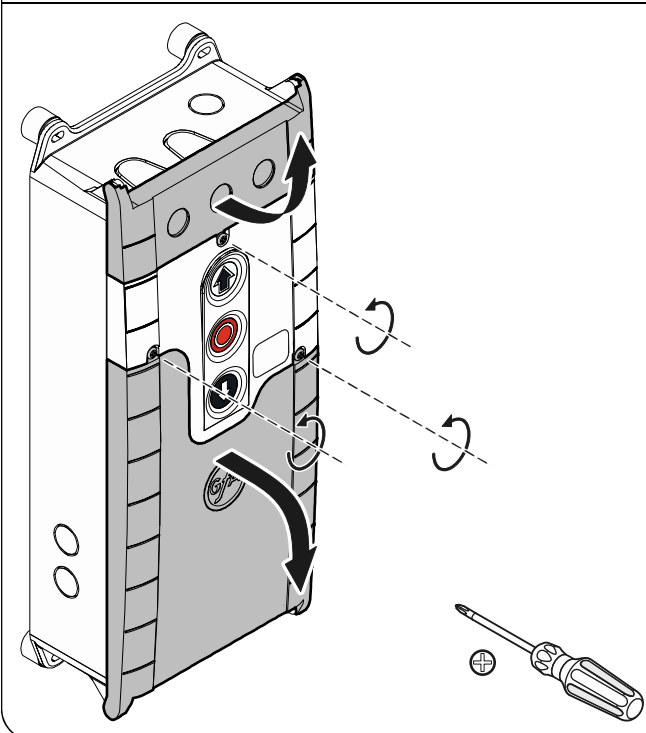

- ▶ Open cable entry ① or ②.

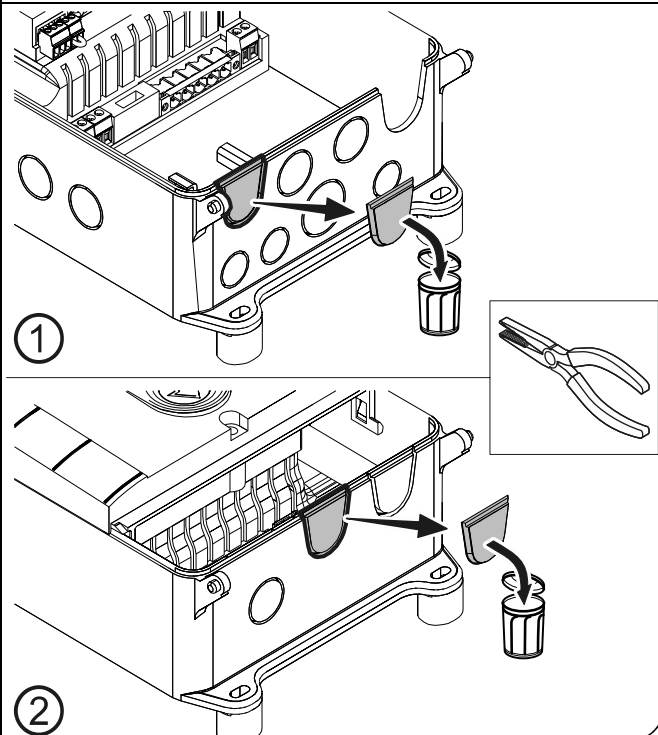

- ▶ Insert and connect connection cable in the open cable entry ① (from below) or ② (from above).
- ▶ Properly tighten cable glands.

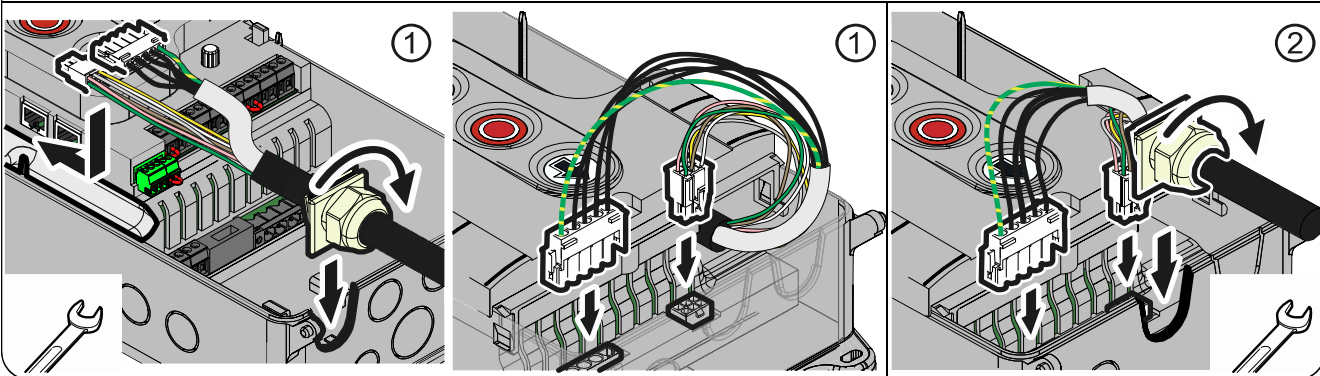

### Caution - Damage of components!

- Open cable entry with suitable tool
- Install cable entries and/or cable glands

## Mains connection

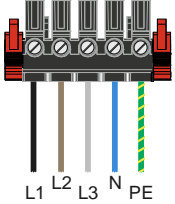
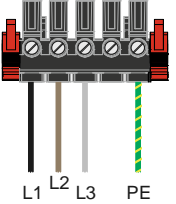
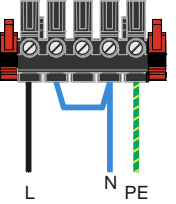
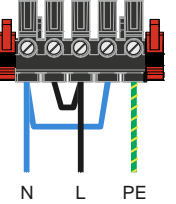
3-phase current, with neutral conductor	3-phase current without neutral conductor	1-phase symmetrical	1-phase asymmetrical
			

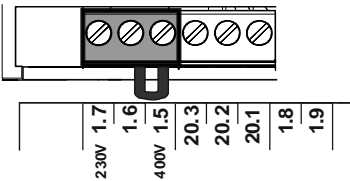
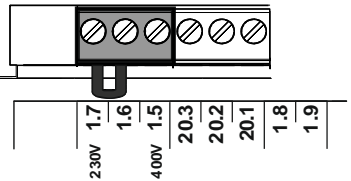
3 x 400V	1 x 230V / 3 x 230V
	

## Mains connection to control

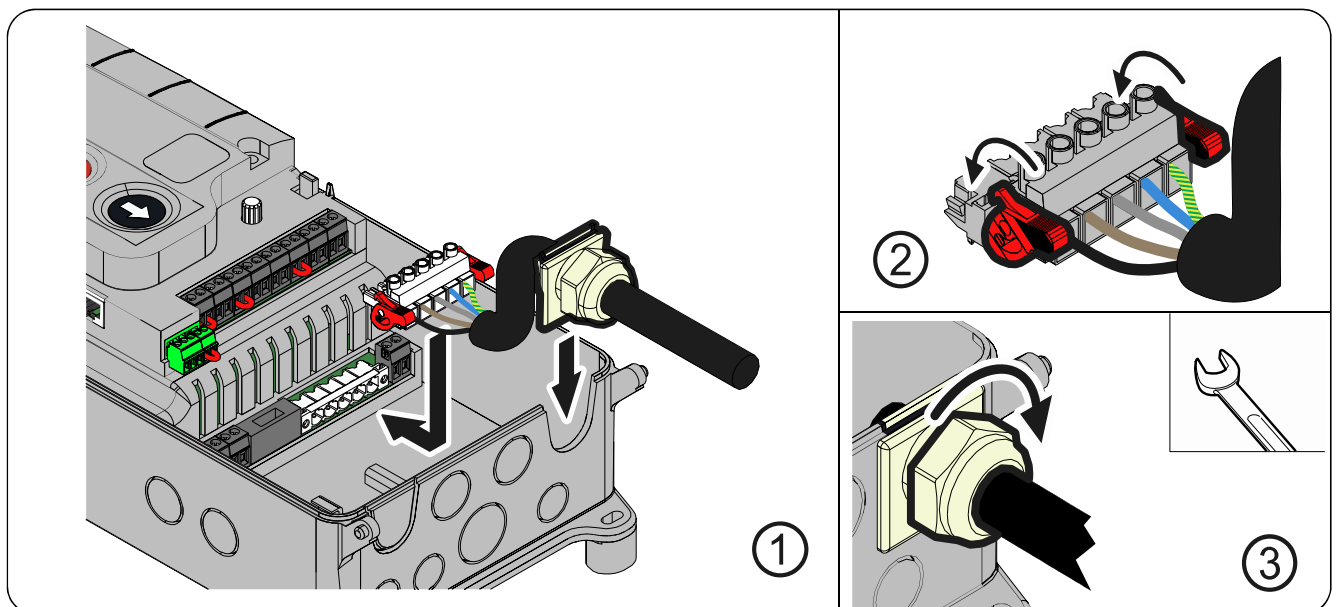

## Completing the electrical installation

Connect any other control devices and/or safety devices.

Install and tighten cable entries and/or cable glands.

For initial operation, leave the control covers open.

## Overview of control

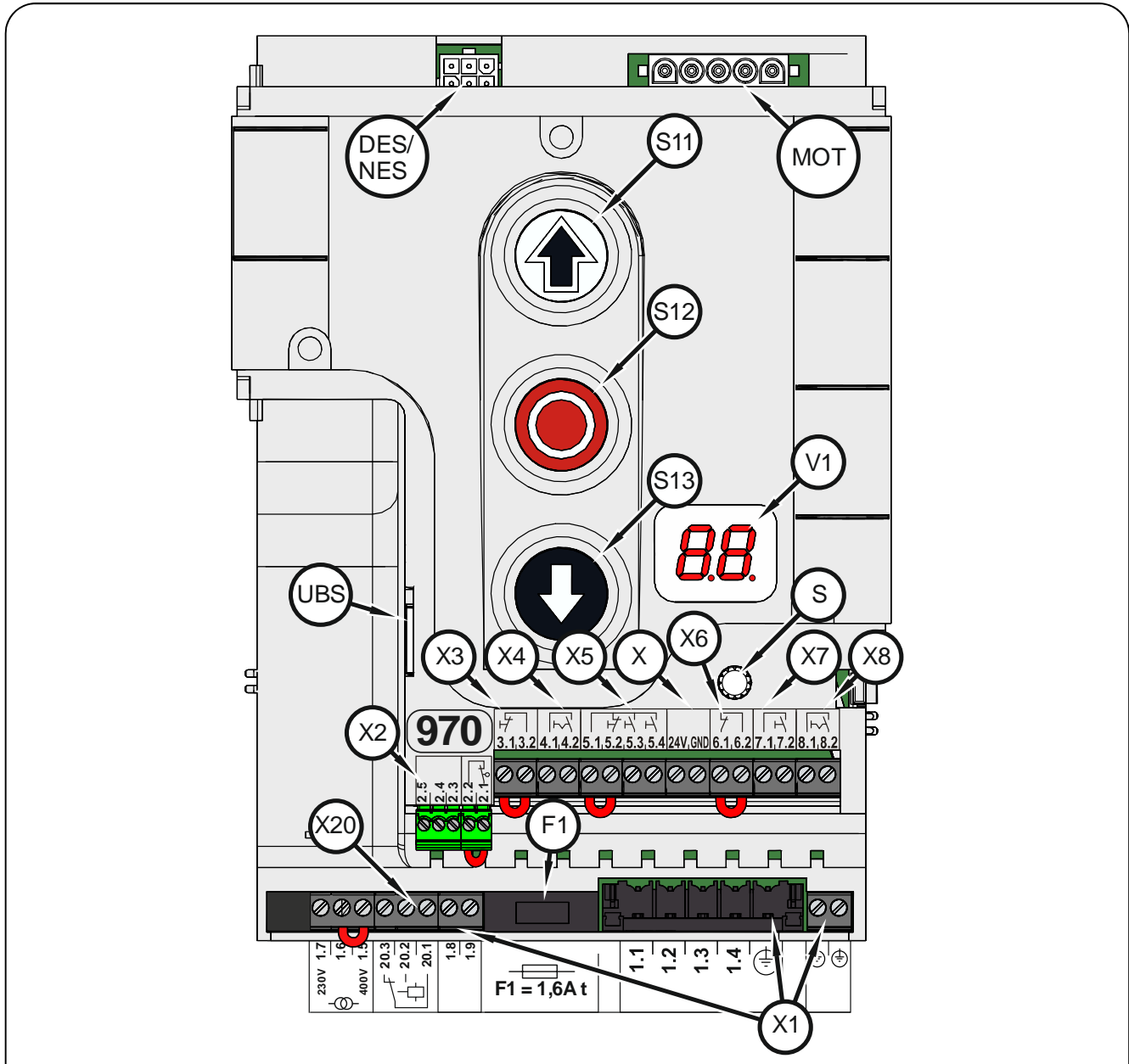

<b>DES/ NES</b>	DES or NES limit switch socket	<b>X</b>	24 V mains supply, external devices
<b>MOT</b>	Motor socket	<b>X1</b>	Mains supply
<b>F1</b>	Micro-fuse 1.6 A time lag	<b>X2</b>	Safety edge system and Door safety switch
<b>S</b>	Selector switch	<b>X3</b>	Emergency stop button
<b>S11</b>	Open push-button	<b>X4</b>	Automatic closing On/Off
<b>S12</b>	Stop button	<b>X5</b>	Control device, external three push-button
<b>S13</b>	Close push-button	<b>X6</b>	Through photo cell, reflective photo cell
<b>UBS</b>	Universal command sensor socket	<b>X7</b>	Pull switch
<b>V1</b>	Display	<b>X8</b>	Intermediate open On/Off
		<b>X20</b>	Potential-free relay contact 1

## 5 Starting up the control

- ▶ Plug in or switch on the mains supply line

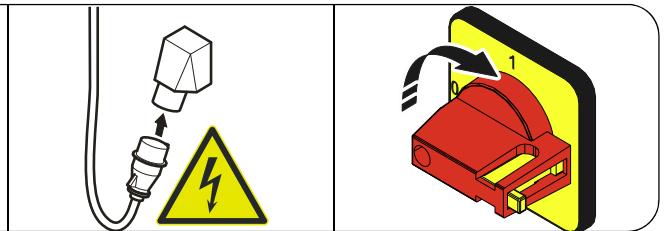

### DES: Rapid adjustment of final limit positions

#### 1. Check rotating direction

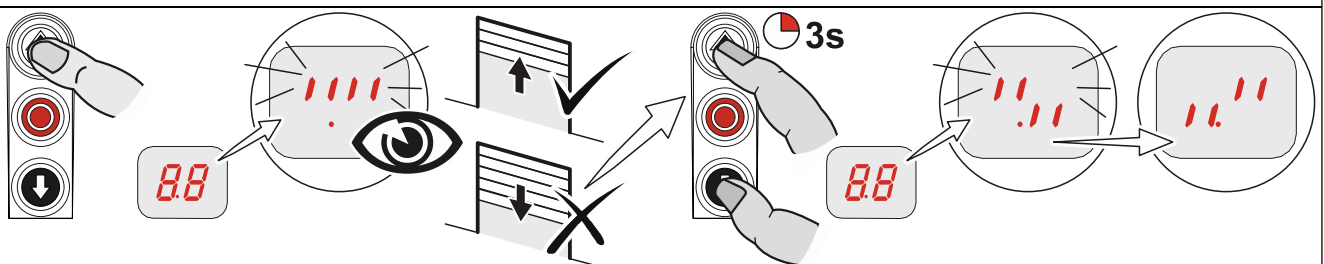

#### 2. Move to open final limit position

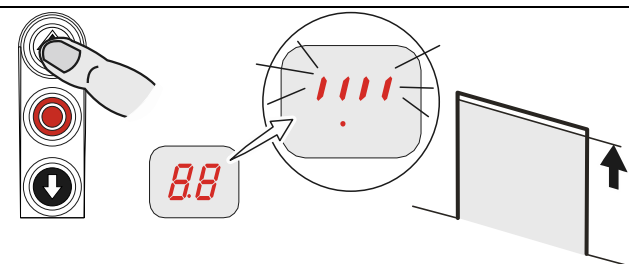

#### 3. Save open final limit position

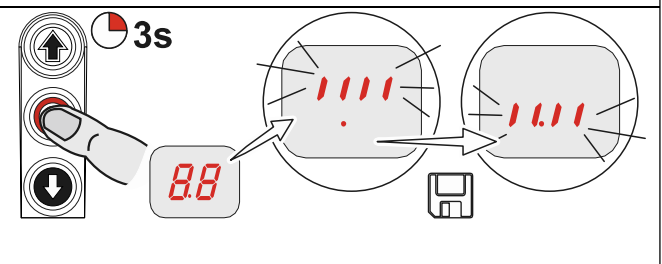

#### 4. Move to close final limit position

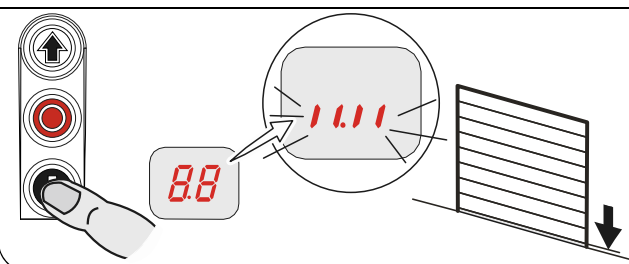

#### 5. Save close final limit position

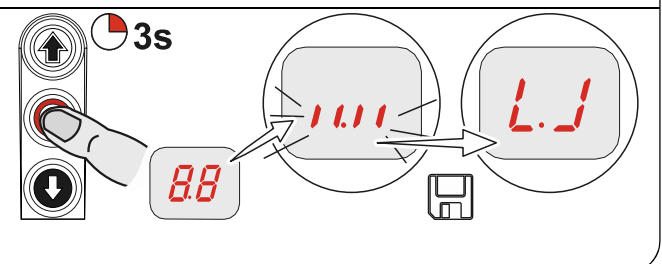

#### Note!

- Rapid adjustment is complete, "Hold-to-run" door operating mode is active
- Change of OPEN/CLOSE final limit positions via menu items "1.1" to "1.4"
- Pre-limit safety edge adjusts automatically
- Changing the pre-limit position is possible via menu item "1.5"



**i** Read the drive unit installation instructions!

- For adjusting the mechanical limit switch, see the drive unit installation instructions

### NES: Rapid adjustment of final limit positions

**1. Check rotating direction**

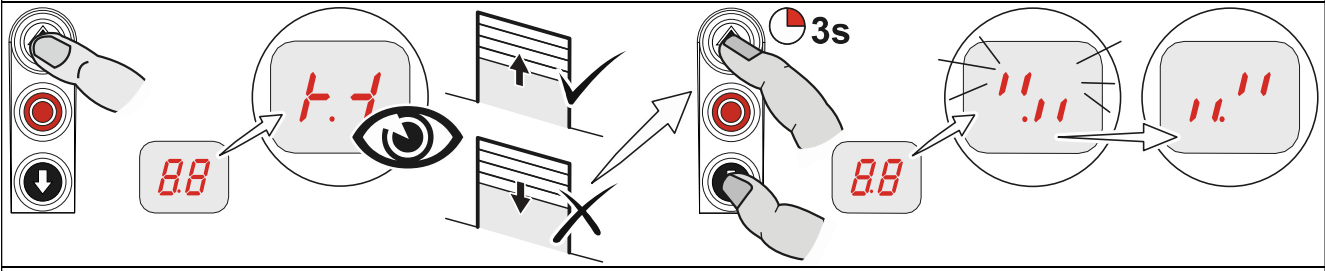

**2. Move to open final limit position and adjust S3 OPEN limit switch**

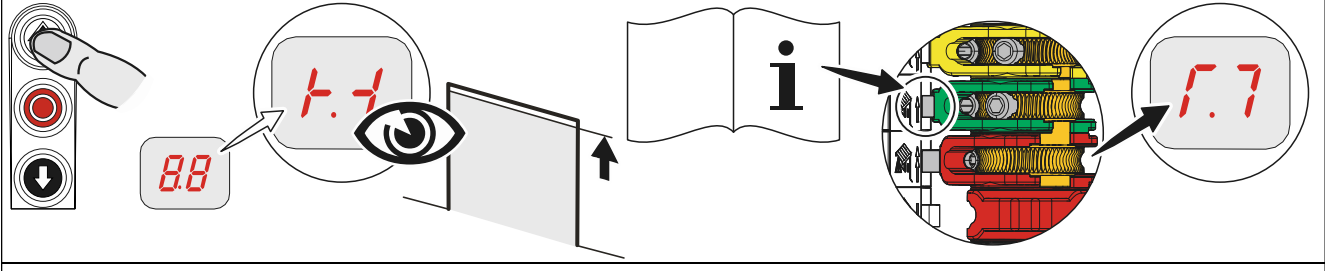

**3. Move to close position 5cm above the ground and adjust S5 pre-limit switch**

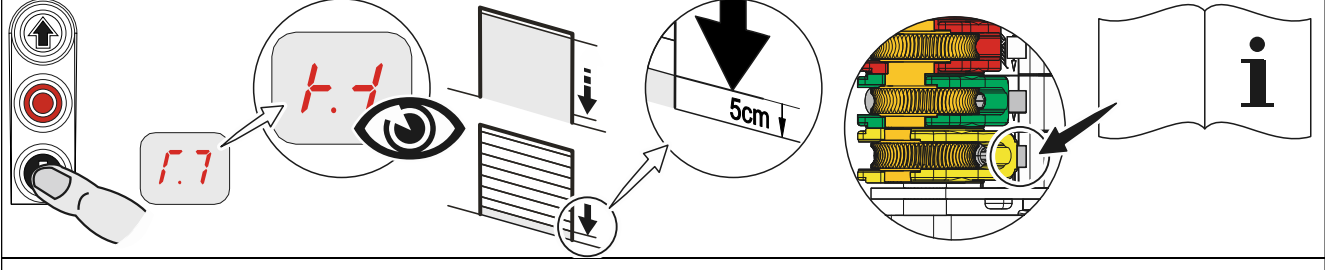

**4. Move to close final limit position and adjust S4 CLOSE limit switch**

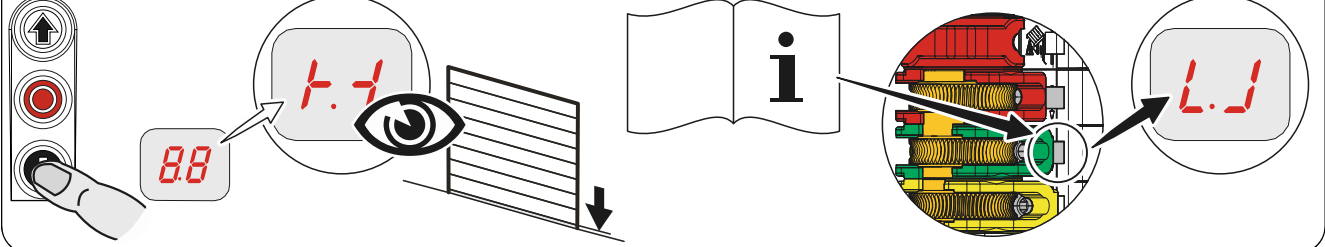

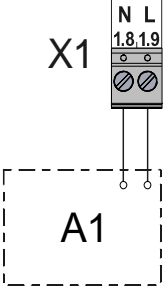
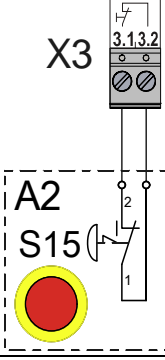
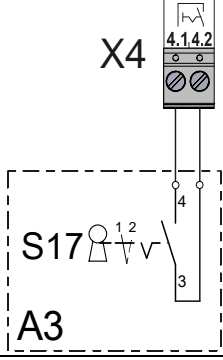

## 6 Electrical installation – control accessories

X1 External supply		X3 Emergency stop		X4 Automatic closing On/Off	
					
<b>A1</b>	External device	<b>A2</b>	Control device Emergency stop	<b>A3</b>	Control device Key-switch

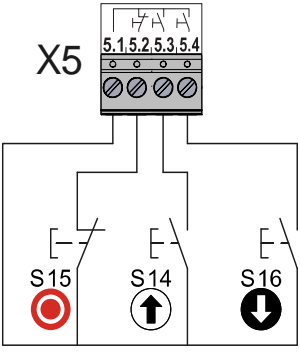
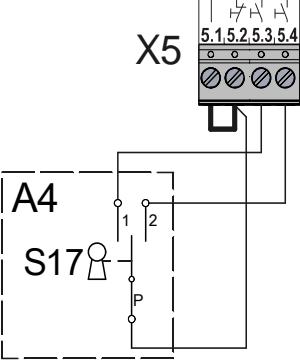
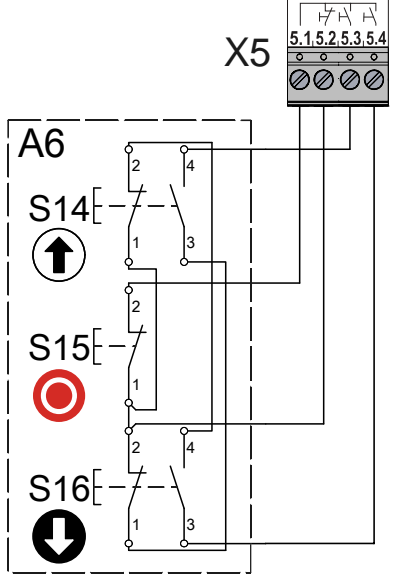
X5 Control device					
					
		<b>A4</b>	Key-switch	<b>A6</b>	Three push-button

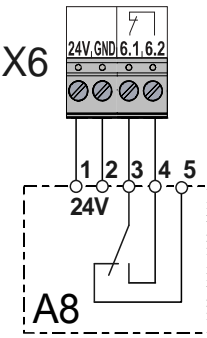
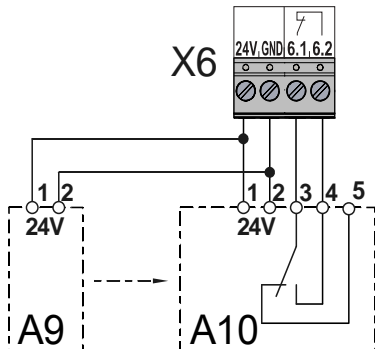
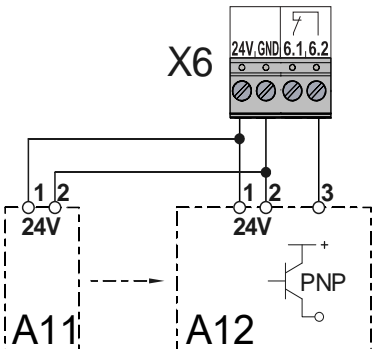
X6 Photo cell					
					
<b>A8</b>	Reflective photo cell	<b>A9</b> <b>A10</b>	Through photo cell Transmitter Receiver	<b>A11</b> <b>A12</b>	Through photo cell Transmitter Receiver

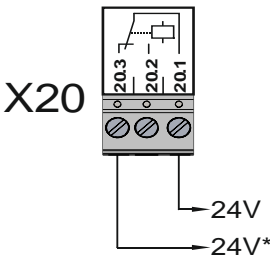
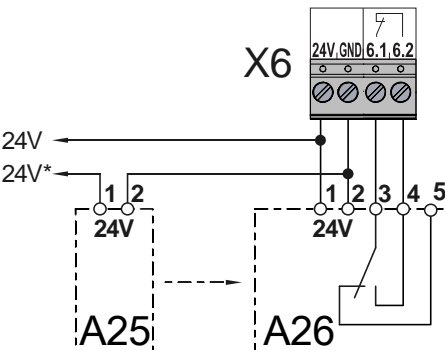
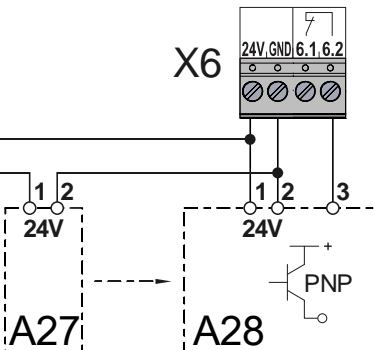
X6 Light curtain					
					
<b>X20</b>	Function relay	<b>A25</b> <b>A26</b>	Light curtain Transmitter Receiver	<b>A27</b> <b>A28</b>	Light curtain Transmitter Receiver

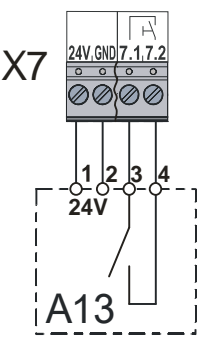
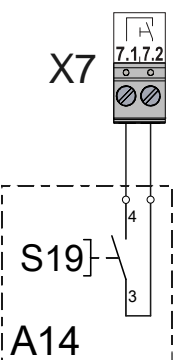
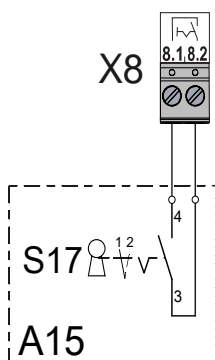
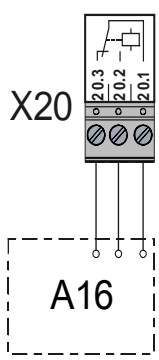
X7 Radio receiver	X7 Pull switch	X8 Intermediate open	X20 Relay contact
			

## Spiral cable connection

### Electrical safety edge system

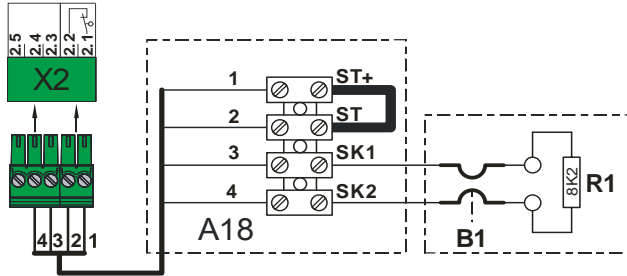

- A18** Junction box
- St+** Voltage supply
- ST** Door safety switch input
- SK1** Electrical safety edge system input
- SK2** Electrical safety edge system input
- B1** Electrical safety edge system
- R1** End of line resistor 8k2
- X2** Door control socket

### Pneumatic safety edge system

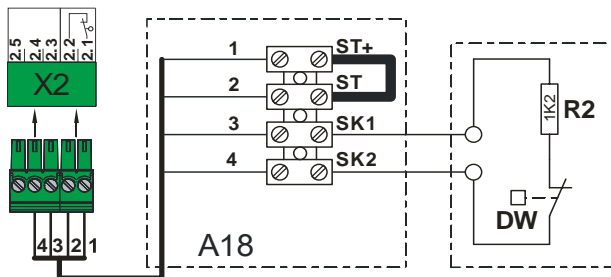

- A18** Junction box
- ST+** Voltage supply
- ST** Door safety switch input
- SK1** Pneumatic safety edge system input
- SK2** Pneumatic safety edge system input
- DW** Pneumatic switch
- R2** Series resistor 1k2 testing
- X2** Door control socket

### Optical safety edge system

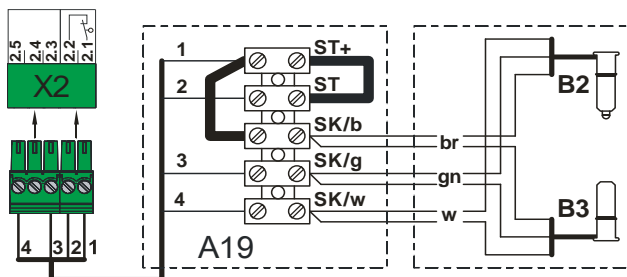

- A19** Junction box
- ST+** Voltage supply
- ST** Door safety switch input
- SK/b** Mains supply (brown)
- SK/g** Output (green)
- SK/w** Ground (white)
- B2** Optical transmitter
- B3** Optical receiver
- X2** Door control socket

### Door safety switch

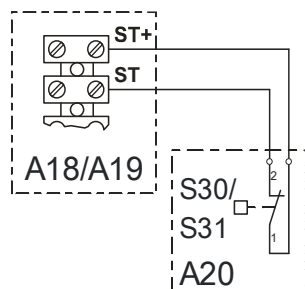

- A18** Junction box
- A19** Junction box
- A20** Junction box switch
- S30** Pass-door switch (NC)
- S31** Slack-rope switch (NC)

### Door safety switch, crash switch

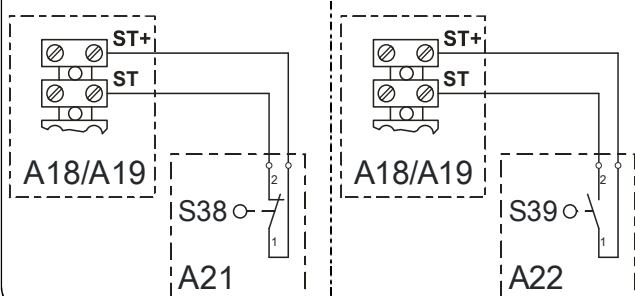

- A18** Junction box
- A19** Junction box
- A21** Junction box switch
- S38** Crash switch (NC)
- A22** Junction box switch
- S39** Crash switch (NO)

## Completing the electrical installation

If required, connect other electrical equipment and/or safety devices, install cable entries and/or cable glands.

## 7 Control programming

1. Programming can only be accessed after rapid adjustment of final limit positions!

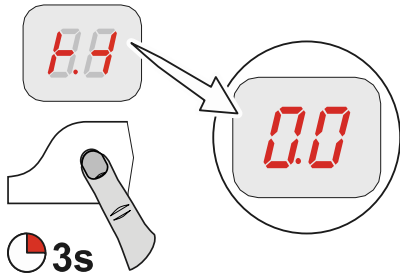

2. Select menu item and confirm

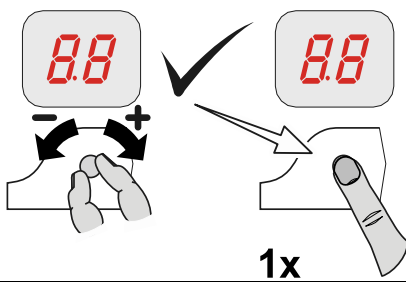

3.a) Set and save functions

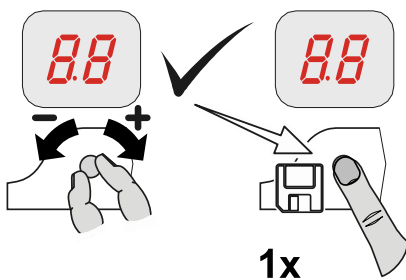



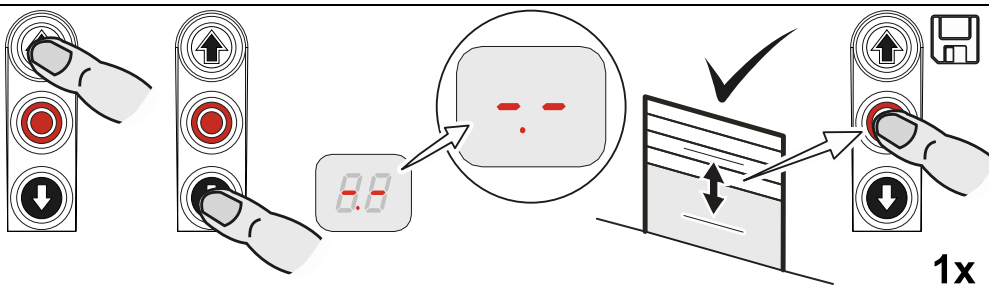



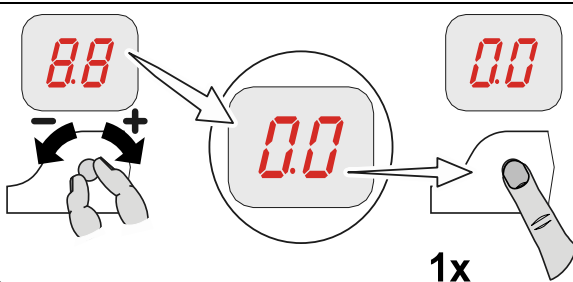













3.b) Set and save positions





















































4. Exit programming

















## 8 Table of menu items

Operating mode			
	 1x	<b>Door operating mode</b>	
		OPEN Hold-to-run CLOSE Hold-to-run	 1x 
		OPEN Self-hold CLOSE Hold-to-run	
		OPEN Self-hold CLOSE Self-hold	
		OPEN Self-hold CLOSE Self-hold, CLOSE hold-to-run release via external X5 control device	
		OPEN Hold-to-run CLOSE Hold-to-run with active safety edge system	
	 1x	<b>Rotating direction</b>	
 		Maintain rotating direction	 1x  3s
		Change rotating direction	





















Door positions					
	 1x	<b>OPEN final limit position, coarse correction</b>			
			OPEN/CLOSE door movement		 1x
	 1x	<b>CLOSE final limit position, coarse correction</b>			
			OPEN/CLOSE door movement		 1x
	 1x	<b>OPEN final limit position, fine correction</b>			
				Without door movement, [+] correct in OPEN [-] correct in CLOSE	
	 1x	<b>CLOSE final limit position, fine correction</b>			
				Without door movement, [+] correct in OPEN [-] correct in CLOSE	
	 1x	<b>Pre-limit safety edge, fine correction</b>			
				Without door movement, [+] correct in OPEN [-] correct in CLOSE	
	 1x	<b>Intermediate open</b>			
			OPEN/CLOSE door movement For NES: Set additional S6 limit switch		 1x
	 1x	<b>Adjust position of relay switching point</b> Select relay function via menu item 2.7			
			OPEN/CLOSE door movement For NES: Set additional S6 limit switch		 1x

### Door functions part 1



















2.1		Safety edge function in the pre-limit area			
		Safety edge system active	 1x		
		Safety edge system inactive			
		Ground adjustment (DES)			
		Reversing upwards in the overrun area (DES)			
2.2		Overrun correction (DES)			
		Off	 1x		
		On			







## Door functions part 2

<b>23</b>	 1x	<b>Automatic closing</b>		<b>00</b>	
	<b>00</b>		<b>2- 40</b>	0 to 240 seconds	
 1x					
<b>24</b>	 1x	<b>Advanced photo cell function</b>			
	<b>.0</b>	Off			 1x
	<b>.1</b>	Cancel automatic closing and CLOSE command			
	<b>.2</b>	Vessel recognition Cancel automatic closing and CLOSE command if photo cell is activated > 1.5 seconds			
<b>25</b>	 1x	<b>Reversing</b>			
	<b>00</b>		<b>10</b>	1 to 10 safety device activations	
					 1x
<b>26</b>	 1x	<b>Pull switch or radio receiver function X7</b>			
	<b>.1</b>	Pulse type 1 Door is not in OPEN final limit position      OPEN command Door is in OPEN final limit position          CLOSE command			 1x
	<b>.2</b>	Pulse type 2 Step by step command order OPEN – STOP – CLOSE – STOP			
	<b>.3</b>	Pulse type 3 OPEN command only			



























### Door functions part 3

2.7		Relay function on X20		1x		Teach-in door position via menu item 1.7 (DES only)			
		Off							
		Pulse signal for 1 second							
		Permanent signal							
		Red lamp, permanent light during door movement OPEN final limit position 3 seconds flashing CLOSE final limit position 3 seconds flashing							
		Red lamp, permanent light during door movement OPEN final limit position 3 seconds flashing CLOSE final limit position Off							
		Red lamp, permanent light during door movement OPEN final limit position 3 seconds permanent light CLOSE final limit position 3 seconds permanent light							
		Red lamp, permanent light during door movement OPEN final limit position 3 seconds permanent light CLOSE final limit position Off							
		Green light Permanent light, at OPEN final limit position							
		Light sensing device 1 second pulse at each OPEN command							
		Permanent contact at door position							
		Brake control Active during operation Inactive at stop							
		Clearance dock leveller Active at OPEN final limit position only							
		Light curtain test, etc. Test before each closing operation							























































### Door functions part 4

<b>2.9</b>		<b>Partly open function</b>		
1x				
	<b>.1</b>	All command inputs active		
	<b>.2</b>	Input X7.2 and internal radio receiver active		
	<b>.3</b>	Input X5.4 and OPEN push-button active		





















### Safety functions

<b>3.1</b>		<b>Force monitoring (DES)</b>			<b>.0</b>	
1x						
	<b>.0</b>	<b>.2</b>		<b>1.0</b>	0 = Off Adjustable from 2 % to 10 % overload	
<b>3.2</b>		<b>Interruption to photo cell operation</b>				
1x						
	<b>.0</b>	Off				
	<b>.1</b>	On (teach-in the same reference position twice)				
<b>3.3</b>		<b>Travel time monitoring (NES) only</b>			<b>9.0</b>	
1x						
	<b>0.0</b>		<b>9.0</b>	0 = Off 0 to 90 seconds		
<b>3.4</b>		<b>Door safety switch function</b> (input X2.2)				
1x						
	<b>.1</b>	Slack-rope or pass-door switch				
	<b>.2</b>	Crash detector (NC contact)				
	<b>.3</b>	Crash detector (NO contact)				
<b>3.8</b>		<b>Reversing duration adjustment</b>			<b>-0</b>	
1x						
	<b>-0</b>	<b>-1</b>	<b>-3</b>	[+] slower [-] faster		











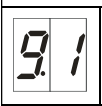
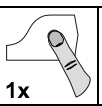























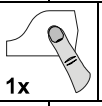

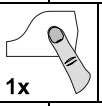















### DU/FI settings

4.1		<b>OPEN output speed</b>	
			Output speed in rpm  1x
4.2		<b>CLOSE output speed</b>	
			Output speed in rpm  1x
4.3		<b>Increased CLOSE output speed</b> To opening height of 2.5 m	
			Output speed in rpm 0 = Off  1x
4.4		<b>Changeover position to CLOSE output speed</b> (observe minimum opening height of 2.5 m!)	 
		OPEN/CLOSE door movement	 1x
4.5		<b>OPEN acceleration</b>	
			DU Steps of 1.0 seconds FI Steps of 0.1 seconds  1x
4.6		<b>CLOSE acceleration</b>	
			DU Steps of 1.0 seconds FI Steps of 0.1 seconds  1x
4.7		<b>OPEN brake</b>	
			DU Steps of 1.0 seconds FI Steps of 0.1 seconds  1x
4.8		<b>CLOSE deceleration</b>	
			DU Steps of 1.0 seconds FI Steps of 0.1 seconds  1x
4.9		<b>OPEN/CLOSE crawling speed</b>	
			Output speed in rpm  1x





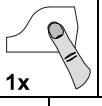

### Maintenance cycle counter

		<b>Maintenance cycle adjustment</b>						
					01-99 corresponds to 1,000 to 99,000 cycles Cycles are counted down			
		<b>Reaction on reaching zero</b>						
		"CS" display with set value of maintenance cycle						
		Changeover to hold-to-run and "CS" display with set value of maintenance cycle						
		Changeover to hold-to-run and "CS" display with set value of maintenance cycle. Pressing the Stop button for 3 sec re-enables 500 automatic cycles						

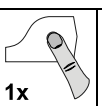
### Readout information store

		<b>Cycle counter reading</b> 7-digit number																						
  	<table style="width: 100%; text-align: center;"> <tr> <td></td> <td></td> <td></td> <td></td> <td></td> <td></td> <td></td> </tr> <tr> <td>M</td> <td>HT</td> <td>ZT</td> <td>T</td> <td>H</td> <td>Z</td> <td>E</td> </tr> </table> <p>Cycle counter reading in divisions of ten consecutively</p> <table style="width: 100%; text-align: center;"> <tr> <td>M = 1,000,000</td> <td>ZT = 10,000</td> <td>H = 100</td> <td>E = 1</td> </tr> <tr> <td>HT = 100,000</td> <td>T = 1,000</td> <td>Z = 10</td> <td></td> </tr> </table>									M	HT	ZT	T	H	Z	E	M = 1,000,000	ZT = 10,000	H = 100	E = 1	HT = 100,000	T = 1,000	Z = 10	
																								
M	HT	ZT	T	H	Z	E																		
M = 1,000,000	ZT = 10,000	H = 100	E = 1																					
HT = 100,000	T = 1,000	Z = 10																						
		<b>Last Fault</b>																						
	The six most recent faults are indicated alternately																							
		<b>Cycle counter reading of the last programming change</b> 7-digit																						
  	<table style="width: 100%; text-align: center;"> <tr> <td></td> <td></td> <td></td> <td></td> <td></td> <td></td> <td></td> </tr> <tr> <td>M</td> <td>HT</td> <td>ZT</td> <td>T</td> <td>H</td> <td>Z</td> <td>E</td> </tr> </table> <p>Cycle counter reading in divisions of ten consecutively</p> <table style="width: 100%; text-align: center;"> <tr> <td>M = 1,000,000</td> <td>ZT = 10,000</td> <td>H = 100</td> <td>E = 1</td> </tr> <tr> <td>HT = 100,000</td> <td>T = 1,000</td> <td>Z = 10</td> <td></td> </tr> </table>									M	HT	ZT	T	H	Z	E	M = 1,000,000	ZT = 10,000	H = 100	E = 1	HT = 100,000	T = 1,000	Z = 10	
																								
M	HT	ZT	T	H	Z	E																		
M = 1,000,000	ZT = 10,000	H = 100	E = 1																					
HT = 100,000	T = 1,000	Z = 10																						
		<b>Firmware version</b>																						
	The firmware version of the control is displayed. In conjunction with DU or FI, additional firmware version of DU or FI.																							

### Clear

		<b>Clear all settings</b>	
 			 1x
		<b>All (factory setting)!          Except for cycle counter</b>	 3s

## 9 Safety devices

### X2: Input, door safety switch

The door safety switch is installed on the door and connected to the door control via the spiral cable.

Menu item "3.4":

Function type	Reaction upon activation
"1" Slack-rope/pass-door	Switch contact open: Door stops
	Switch contact closed: Door ready for operation
"2" Crash switch as NC	Switch contact open: Door stops
	Switching contact closed: Changeover to hold-to-run mode With frequency inverter: Door moves at crawling speed only Resetting the error: Press the stop button of the door control for 3 seconds
"3" Crash switch as NO	As function type "2"

#### Slack-rope/pass-door

If the switch is open and simultaneously the command from the final limit positions is active, the "F1.2" fault indication is displayed. If activation occurs during the door movement, there is an immediate stop and the "F1.2" fault indication is displayed.

#### Pass-door switch: Entry sense

The switch, tested in performance level c (plc) category 2 (as defined in EN 13849-1), is monitored by the door control. If the switch is open and simultaneously the command from the final limit positions is active, the "F1.2" fault indication is displayed. If activation occurs during the door movement, there is an immediate stop and the "F1.2" fault indication is displayed.

The magnetic contacts in the switch are switched by a permanent magnet. The door control assesses the switching status of the contacts independently of each other.

The "F1.7" fault indication appears if there is a fault.

### **Crash switch as NC or NO contact**

The crash switch is activated if the door is pushed out of the guides. The door is stopped and fault F4.5 is displayed, if the switching contact is activated. After resetting the switching contact, operation is switched to hold-to-run mode. The door can be moved only via the integrated push-buttons, and at crawling speed in frequency inverter operation.

Reset fault indication "F4.5" by pressing the stop button for more than 3 seconds or by switching the mains voltage off and on.

### **X2: Input, safety edge system**

The door control automatically detects three different safety edge systems.

1K2 resistor evaluation

8K2 resistor evaluation

Optical safety edge system



#### **Important!**

- Connect safety edge systems in accordance with EN 12978
- The hold-to-run control can always be used should the safety edge system be defective



#### **Important!**

- Check the pre-limit safety edge position
- The door must stop and re-open if the safety edge is activated when the door is opened > 5cm.



## Function of the safety edge system in the pre-limit area

Menu item "2.1":

Function type	Reaction upon activation of the safety edge system
"1" Active	Stop
"2" Inactive	No reaction; door moves to CLOSE final limit position
"3" Ground adjustment (DES)	Stop; correction of the CLOSE final limit position at the next closing
"4" Reversing in the pre-limit area (DES)	Reversing upwards from the overrun area upon activation of the safety edge system



### Note: Ground adjustment!

- Automatic compensation of rope stretches or changes in ground conditions of approx. 2-5 cm
- With DES limit switch only
- Do not use with overrun correction
- Do not use with pneumatic switch



### Note: Reversing upwards in the overrun area!

- To maintain the operating forces in the pre-limit area
- At high speeds
- With DES limit switch only
- Function for FI-drive units not necessary

## Function of overrun correction

Menu item "2.2":

Automatic limit switch correction to achieve a constant CLOSE position.

Function type	Overrun correction
"0"	Off
"1"	On



### Note: Overrun correction!

- With DES limit switch only
- Do not use with ground adjustment

## Reversing function

Menu item "2.5":

Setting of maximum number of operations for safety-edge activations at automatic closing. If the set value is exceeded, automatic closing is deactivated and the "F2.2" fault indication is displayed.



### Note!

- Reset of fault indication "F2.2": Upon reaching the CLOSE final limit position

## X3: Input, emergency stop

Connection of an emergency stop control device as per EN 13850 or an evaluation unit for an anti-trap safety device. The "F1.4" fault indication appears upon activation.



### Note!

- With FI-drive units, only the drive unit is de-energised by the emergency stop

## 10 Functional description

### X: 24 V DC voltage supply

Connection of external devices such as photo cell, radio receiver, relay, etc. via the 24 V and GND terminals.



#### Caution - Damage of components!

- Total current consumption of external devices: maximum 180 mA

### X1: Mains supply line for control and external supply

#### Mains supply line for control

Connection via terminals X1/1.1 to X1/1.4 and PE.

Various mains supply connections: 3 N~, 3~, 1 N~ for symmetric and asymmetric motors.

400V mains = 1.5 - 1.6 wire link

230V mains = 1.6 - 1.7 wire link



#### Note!

- ▶ Pay attention to the "Mains supply connection" and "Mains supply connection to control" descriptions

### External supply

Connection of external devices for 230 V, such as photo cell, radio receiver, relay, etc. via terminals X1/1.8 and X1/1.9.



#### Note!

- Supply of external devices 3 N~400 V or 1 N~230 V, symmetric
- Protection via F1, 1.6-A time-lag micro-fuse

#### X4: Input, automatic closing Off/On

Connection of a switch via terminals X4/1 and X4/2 for switching the automatic closing off and on.

#### X5: Control device



##### Warning!

- "Hold-to-run" door operating mode:  
The door must be fully visible from the operating point

Door operating mode "3" allows a place of assembly of the control device without sight of the door. If the safety edge system or photo cell fails, the control device does not function.



##### Note!

- ▶ Wire link X5.1 to X5.2 for using the control device without stop button

## X6: Input, through / reflective photo cell or light curtain

### Photo cell

A photo cell is used for presence detection. It is only active in door operating modes "3" and "4", in the OPEN final limit position or during the closing operation.

If the photo cell is interrupted, fault indication "F2.1" appears.

### Light curtain

The light curtain must be self-testing and correspond at least to safety category 2 or performance level c (plc). If the light curtain corresponds to these requirements, the door can close into self-hold without safety edge system.



#### Important!

- ▶ Operation without safety edge system, connect 8K2 resistor via terminals X2/3 and X2/3
- ▶ Photo cells must not be used via the UBS system
- ▶ Do not use menu item "3.2" for the light curtain

To test the light curtain, activate relay contact X20 or X21. For a description of the relay functions see menu item "2.7". If the photo cell is interrupted, fault indication "F4.6" appears. Testing is carried out at each CLOSE command, the contact of the light curtain must switch off within 100 ms. If the test is positive, the contact must switch back on within 300 ms. If the test fails, fault indication "F4.7" appears.

Reset fault indication "F4.7": Switch control off and on.



#### Note!

- • Only use photo cells or light curtains with "Light switching" mode

## Effect of interrupting the photo cell

Door position	Effect of interrupting the photo cell
CLOSE final limit position	No function
Upwards travel	No function
OPEN final limit position Without automatic closing	No function
OPEN final limit position With automatic closing	Reset automatic closing
OPEN final limit position With automatic closing and interruption to timer	The door closes 3 seconds after the interruption period for the photo cell has ended

## Advanced photo cell function

Menu item "2.4":

Function type	Advanced photo cell functions
"0"	No function
"1" automatic closing	The door closes 3 seconds after the interruption period for the photo cell has ended
"2" vessel recognition	Door closes if photo cell is interrupted for more than 1.5 seconds. No action if photo cell is interrupted for less than 1.5 seconds.

## Interruption to photo cell operation

Menu item "3.2"

Function type	Interruption to photo cell operation
"0"	Off
"1"	On



Teach-in mode first active when exiting the programming.



### Warning!

- Presence detection is disabled in the teach-in mode

In the teach-in mode, the door must be fully opened and closed twice. The photo cell must be interrupted twice at the same door position. The teach-in mode is then terminated. The photo cell has no function below this stored door position.

Teach-in mode display	
Upon exiting the programming	
When the light beam is interrupted for the first time	
After the second interruption to the light beam at the same door position, and with the CLOSE final limit position reached	



### Note!

- If the teaching-in is not successful, open and close the door again, so that two identical door positions are stored

## X7: Input, pull switch/radio receiver

Connection of a pull switch or external radio receiver via terminals X7/1 and X7/2. The switching contact must be potential-free (NO contact).

### Pull switch or radio receiver function

Menu item "2.6":

Pulse type	Reaction upon activation
"1"	The door CLOSSES from the open final limit position or the intermediate open. The door OPENS from all other door positions or door movements.
"2"	OPEN-STOP-CLOSE-STOP command serie
"3"	Door always executes OPEN movement



## X8: Input, intermediate open On/Off

Connect a switch to terminals X8/1 and X8/2 to activate and deactivate the intermediate open. Set the intermediate open position via menu item "1.6".

With an OPEN command, the door moves to the stored door position. When the intermediate open function is deactivated, the door can move back to the OPEN final limit position.

### Partly open function

Menu item "2.9":

Function type	Intermediate open
"1"	All command inputs
"2"	Intermediate open via X7 pull switch. OPEN final limit position via all other control devices.
"3"	Intermediate open via external X5 control device and internal control device. OPEN final limit position via all other control devices.

## X20: Potential-free relay contact

The relay functions are described under menu item "2.7".



### Caution - Damage of components!

- Maximum current of 1 A at 230 VAC and 0.4 A at 24 VDC
- We recommend the use of LED lamps
- When using light bulbs, these should have power of maximum 40 W and be shock-proof

## Force monitoring (DES only)

Menu item "3.1":

The force monitoring function can only be used with fully balanced doors and drive units with DES switches. It should be able to detect when persons are moving with the door



### Warning!

- The force monitoring is no substitute for safety measures in providing protection against the trapping hazard

Function type	Force monitoring
"0"	Off
"2" - "10"	2 - low limit value 10 - high limit value



### Important!

- Force monitoring for doors with spring balance only
- Environmental factors such as temperature or wind load can lead to inadvertent triggering of the force monitoring

After exiting programming, the door must carry out a full opening and closing operation in self-hold mode.

The force monitoring is a self-learning system which is effective for an opening width range of 5 cm to 2 m (approx.). Slow progressive changes, e.g. gradual reduction of the spring torsion, are compensated for automatically.

If force monitoring is triggered, only the "hold-to-run" door operating mode is possible and the "F4.1" fault indication is displayed. Resetting occurs when a final limit position for the door is reached.

### Travel time monitoring (NES only)

Menu item "3.3"

The set travel time is automatically compared with the time measured for movement between the final limit positions. If the travel time is exceeded, the "F5.6" fault indication appears.

Fault indication "F5.6" is reset by closing the door.



#### Note!

- The travel time is set at the factory to 90 seconds
- Recommended setting value: Door travel time + 7 seconds

## UBS system

The UBS system is a simple pluggable connection technology from GfA. The control devices are connected to the control by a commercially available patch cable and detected automatically.



### Note!

- The UBS devices function in the same way as wired control devices

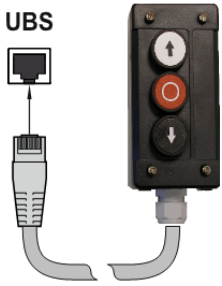
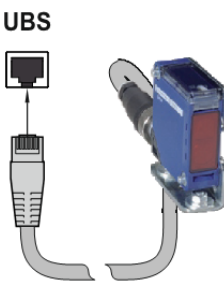
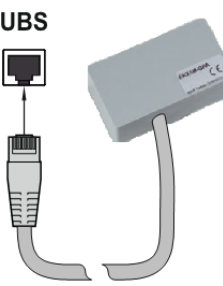
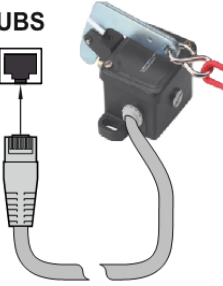
UBS connection			
			
Three push-button	Reflective Photo cell	External Radio receiver	Pull switch

## Reversing duration adjustment

Menu item "3.8":

Shortening the reversing duration will reduce the operating forces. Extending it, on the other hand, will reduce the wear on the door mechanism.

## Maintenance cycle counter

Menu item "8.5":

A value between 0 and 99,000, as a multiple of 1000, can be selected for the maintenance cycle setting.

The maintenance cycle counter reading is reduced by one each time the Open final limit position is reached.

Once the maintenance cycle reaches zero, the setting from menu item "8.6" is activated.

## Short-circuit/overload display

If there is a short circuit or an overload of the 24 VDC supply voltage, the 7-digit display vanishes.

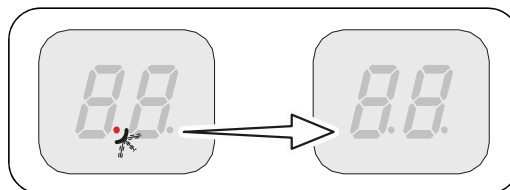

## Standby function

If there is no fault or command pending, the control switches the display to "Standby".





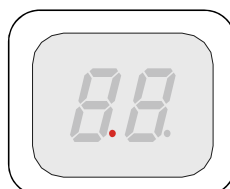



Standby is active if the automatic closing duration is longer than 60 seconds.

Only the left point is displayed.



Execution of the "Standby" function is stopped by issuing a command or by operating the "S" selector switch.

## 11 Status display

Faults		
	Display: "F" and code	
Status-code	Fault description	Measures for fault correction
	Terminals X2.1 – X2.2 are open. Slack-rope/pass-door contact open.	Check door safety switch. Check whether the connection cable is connected.
	DES safety circuit is open. Emergency manual operation has been activated. Thermal protection of the motor has tripped	Check emergency manual operation. Check for overload or stalling of the drive unit.
	Terminal X3.1 – X3.2 is open. Emergency stop has been activated.	Check emergency stop. Check whether the connection cable is connected.
	Faulty "Entry sense" switch. Contact resistances are too high. Faulty entry sense installation.	Open and close pass-door. Check resistance. Check pass-door installation.
	Entry sense input (X2.1 – X2.2) faulty.	Switch control off and on. Replace control if necessary.
	No safety edge is detected.	Check the wiring of the safety edge system.
	Terminals X6.1 – X6.2 are open. Photo cell has been activated.	Check alignment of the photo cell. Check connection cable. Replace photo cell if necessary.
	Maximum number of reversing movements for door through safety edge system activation has been reached. (Only with automatic closing)	Obstacles in the door travel way. Check whether the safety edge system is correctly functioning.

## Faults

Status-code	Fault description	Measures for fault correction
<b>F.</b>	<b>Display: "F" and code</b>	
<b>24</b>	8k2 safety edge system has been activated.	Check whether the safety edge system is correctly functioning. Check whether the connection cable has short-circuited.
<b>25</b>	8k2 safety edge system is defective.	Check whether the safety edge system is correctly functioning. Check whether the connection cable is connected.
<b>26</b>	1k2 safety edge system has been activated.	Check whether the safety edge system is correctly functioning. Check whether the connection cable is connected.
<b>27</b>	1k2 safety edge system is defective.	Check whether the safety edge system is correctly functioning. Check whether the connection cable has short-circuited.
<b>28</b>	1k2 testing is negative.	Testing is activated in the lower final limit position. Check pre-limit switch (with NES "S5").
<b>29</b>	Optical safety edge system has been activated or is defective.	Check whether the safety edge system is correctly functioning.
<b>31</b>	(DES) OPEN emergency stop switch reached.	In the voltage-free state, move the door back via emergency manual operation.
	(NES) OPEN or CLOSE emergency stop switch reached. Emergency manual operation has been activated. Thermal protection of the motor has tripped	Check OPEN/CLOSE emergency stop switch. Check emergency manual operation. Check drive unit for overload or stalling.
<b>32</b>	(DES) CLOSE emergency stop switch reached.	In the voltage-free state, move the door back via emergency manual operation.
<b>34</b>	(NES) Faulty activation of the "S5" pre-limit position.	Check the "S5" pre-limit position for correct functioning and setting.

## Faults

F.	Display: "F" and code	
Status-code	Fault description	Measures for fault correction
3.5	No limit switch detected (active at initial start-up).	Connect the limit switch to the control. Check the limit switch connection cable
3.6	Limit switch system has been changed without the control being reset.	Reset the control via menu item "9.5".
3.7	Internal plausibility error.	Fault clearance with next movement command.
4.1	Triggering of the force monitoring.	Check the door mechanism for stiffness.
4.5	Crash detector (X2.1 – X2.2) has been activated.	Check crash detector or connection cable. Reset error, press stop button for 3 seconds.
4.6	Terminal X6.1 – X6.2 is open. Light curtain has been activated.	Check light curtain. Check whether the connection cable is connected.
4.7	Light curtain is defective.	Comply with the light curtain manufacturer's specification/instructions. Check connection cable.
5.0	Controller fault.	Switch control off and on. Replace control if necessary.
5.1	ROM error.	Switch control off and on. Replace control if necessary.
5.2	CPU error.	Switch control off and on. Replace control if necessary.







## Faults

Status-code	Fault description	Measures for fault correction
<b>F.</b>	<b>Display: "F" and code</b>	
<b>5.3</b>	RAM error.	Switch control off and on. Replace control if necessary.
<b>5.4</b>	Internal control error.	Switch control off and on. Replace control if necessary.
<b>5.5</b>	Digital limit switch error (DES).	Check DES connector and connection cable. Switch control off and on.
<b>5.6</b>	Fault with door movement.	Check the door mechanism for stiffness. Check the limit switches for correct rotational movement. Switch control off and on.
<b>5.7</b>	Fault with rotating direction.	Change rotating direction via menu item "0.2".
<b>5.8</b>	Non-permitted door movement in stopped condition.	Release of failure through command. Check brake and drive unit.
<b>5.9</b>	Drive unit does not follow specified travel direction.	Release of failure through command. Check for overload of the drive unit.
<b>6.1</b>	DU / FI closing speed is too high.	Switch control off and on. Replace drive unit if necessary.
<b>6.2</b>	Internal FI communication failure.	Switch control off and on. Replace FI-drive unit if necessary.
<b>6.3</b>	Low voltage in the DC voltage link.	Release of failure through command. Check mains input voltage. Change slope times/speed.













## Faults

Status-code	Fault description	Measures for fault correction
<b>F.</b>	<b>Display: "F" and code</b>	
<b>6.4</b>	Excess voltage in the DC voltage link.	Check mains input voltage. Release of failure through command. Change slope times/speed.
<b>6.5</b>	Temperature limit exceeded.	Drive unit overload. Cool down the drive unit and reduce the number of cycles.
<b>6.6</b>	Permanent current overload.	Check for overload of the drive unit. Check the door mechanism for stiffness or weight.
<b>6.7</b>	Brake / FI fault.	Check brake, replace if necessary. If problem recurs, replace drive unit.
<b>6.9</b>	FI group message.	Release of failure through command. Replace drive unit if message continues to be displayed.
<b>8.1</b>	Minimum way of travel not reached during initial operation.	Move the door for at least 1 second.













### Commands









	<b>Display: "E" and code</b>
<b>Code</b>	<b>Command description</b>
	An open command is present. Inputs X5.3, X7.2, UBS control device or UBS radio receiver.
	A stop command is present. Inputs X5.2, X7.2, UBS control device or UBS radio receiver or simultaneous Open and Close command.
	A close command is present. Inputs X5.4, X7.2, UBS control device or UBS radio receiver.

## Status indications

Status-display	Description
	Preset value for maintenance cycle counter status reached
	Dot on left is not lit: control circuit has short-circuited or is overloaded.
	Change of rotating direction activated, only possible at initial start-up and FI-drive unit.
	Change of rotating direction carried out, only possible at initial start-up and FI-drive unit.
 Flashing	Teach-in Open final limit position.
 Flashing	Teach-in Close final limit position
 Flashing	Upwards travel active.
 Flashing	Closing operation active.
	Stop between the set final limit positions.
	Stop at the Open final limit position.
	Stop at the intermediate open position.
	Stop at the Close final limit position.

## 12 Explanation of symbols

Symbol	Explanation
	Prompt: Read installation instructions
	Prompt: Check
	Prompt: Note
	Prompt: Note the setting of the menu item below
	Factory setting of the menu item
	Factory setting of the menu item, value on the right
	Factory setting of the minimum limit, dependent on drive unit
	Factory setting of the maximum limit, dependent on drive unit
	Range
	Prompt: Select menu item or value, turn selector switch to the left or to the right
 1x	Prompt: View menu item, press selector switch once
 1x	Prompt: Save, press selector switch once

Symbol	Explanation
	Prompt: Setting via OPEN/CLOSE built in push-button; Use OPEN push-button to increase value, CLOSE push-button to decrease value
 1x	Prompt: Press stop button once via built in push-button
 1x	Prompt: Save, press stop button once via built in push-button
 3s	Prompt: Save, press stop button for three seconds via built in push-button
 3s	Prompt: Reset the control, press stop button for three seconds via built in push-button
	Prompt: Move to door position
	Prompt: Move to door position for OPEN final limit position
	Prompt: Move to pre-limit
	Prompt: Move to door position for CLOSE final limit position

# Declaration of Incorporation

pursuant to Machinery Directive 2006/42/EG for a partly completed machine Appendix II Part B



GfA - Gesellschaft für Antriebstechnik  
Dr.-Ing Hammann GmbH & Co KG  
Wiesenstraße 81  
40549 Düsseldorf

# Declaration of Conformity

pursuant to EMC Directive 2004/108/EC

We,

**GfA – Gesellschaft für Antriebstechnik,**

hereby declare that the product specified in the following complies with the above-mentioned EU Directive and is only intended for installation in a door system

## TS 970

Applied standards

<b>DIN EN 12453</b>	Industrial, commercial and garage doors and gates
<b>DIN EN 12978</b>	Safety devices for power operated doors and gates
<b>DIN EN 60335-1</b>	Household and similar electrical appliances - Safety – Part 1: General requirements
<b>DIN EN 61000-6-2</b>	Electromagnetic compatibility (EMC) - Part 6-2 Generic standards - Immunity for industrial environments
<b>DIN EN 61000-6-3</b>	Electromagnetic compatibility (EMC) - Part 6-3 Generic standards - Emission standard for residential, commercial and light-industrial environments

We undertake to transmit, in response to a reasoned request by the authorities, the special documents for this partly completed machine.

**Authorised representative for the compilation of the technical documentation**

(EU address in the company)

Dipl. Ing. Bernd Synowsky

Documentation representative

Partly completed machinery according to EC Directive 2006/42/EC is only intended to be installed in, or combined with, other machinery (or other partly completed machinery/systems) in order to form a completed machine pursuant to the Directive. This product must therefore only be put into operation when it has been determined that the complete machine/system in which it has been installed complies with the provisions of the above-mentioned directives.

Düsseldorf 23/05/2013

**Stephan Kleine**

Managing Director

  
Signature